

D I G I T A L C O M B A T S I M U L A T O R

# Mi-8 MTV2

## Magnificent Eight

for DCS World



# FLIGHT MANUAL



**DCS**  
S E R I E S

This document is a user manual for the DCS: Mi-8MTV2 Magnificent Eight PC flight simulator. It provides descriptions and instructions required for successful operation of the subject aircraft in the simulation. The DCS user interface and mission editor are described in a separate document included with the product and found in the installation folder.

For additional information and community discussion of the product, please see the official online forums: <http://forums.eagle.ru/>.

© 2013-2016 Belsimtek. All rights reserved.

ATTENTION! By purchasing the software DCS: Mi-8MTV2, you hereby agree not to allow the copying of this software and documentation without written per-mission from Belsimtek.

[www.belsimtek.com](http://www.belsimtek.com)



# TABLE OF CONTENTS

TABLE OF CONTENTS.....	1
IMPORTANT NOTICE!.....	9
<b>1. MI-8 HISTORY .....</b>	<b>11</b>
<b>2. GENERAL DESIGN AND PURPOSE.....</b>	<b>19</b>
2.1. HELICOPTER DIMENSIONS.....	19
2.2. PERFORMANCE SPECIFICATIONS .....	20
2.3. PURPOSE AND MISSIONS .....	21
<b>3. HELICOPTER AERODYNAMICS.....</b>	<b>24</b>
3.1. GENERAL PRINCIPLES .....	24
Forces acting on a helicopter .....	24
CONTROLS.....	26
Velocity.....	26
Torque.....	27
Anti-torque rotor (tail rotor).....	27
Gyroscopic precession .....	28
Dissymmetry of lift.....	28
Retreating blade stall .....	29
Settling with power (Vortex Ring State) .....	31
Hover .....	33
Ground effect .....	33
Translational lift.....	34
Autorotation .....	35
Summary .....	38
3.2. MI-8MTV2 AERODYNAMIC PARTICULARS.....	38
Power requirement for level flight.....	39
Main rotor thrust.....	39
3.3. MI-8MTV2 PERFORMANCE PARTICULARS.....	40
Safe altitudes and airspeeds in case of a single engine failure in flight .....	40
3.4. MI-8MTV2 CONTROL PARTICULARS .....	40
3.5. MI-8MTV2 TRIMMING AND BALANCING .....	41
Ground trim .....	41
Helicopter tendencies at liftoff.....	42
Roll TRIM.....	42
Yaw TRIM .....	42
Trimming in turns, spirals, and coordinated sideslips .....	43
3.6. MI-8MTV2 STABILITY PARTICULARS .....	43
3.7. MI-8MTV2 MANEUVERING PARTICULARS.....	44
Acceleration in level flight .....	44
Deceleration in level flight .....	44
<b>4. POWERPLANT AND DRIVE SYSTEM .....</b>	<b>46</b>
4.1. ENGINES AND RELATED SYSTEMS .....	46
4.1.1. Air Inlet Particle Separator System ("PZU") .....	49
4.1.2. Engine Anti-Ice System.....	50
4.1.3. Engine Fuel System .....	50
Starting Fuel Flow .....	50
Steady State Operation .....	50
Temperature Limiter System Operation.....	50
Compressor Control System Operation.....	51
Engine Governor Operation.....	51
Engine Shutdown.....	52
Fuel Supply Switches.....	52

Power Controls .....	52
Engine Power Synchronizers .....	54
4.1.4. Engine Oil System .....	54
Description .....	54
4.1.5. Ignition-starting system .....	55
4.1.6. Engine Trim Control.....	56
4.2. AUXILIARY POWER UNIT .....	56
4.3. DRIVE SYSTEM .....	58
4.4. AIR COOLING SYSTEM.....	60
<b>5. COCKPIT SYSTEMS AND CONTROLS .....</b>	<b>63</b>
5.1. COCKPIT LAYOUT .....	64
5.1.1. Left Instrument Panel (Pilot) .....	65
5.1.2. Right Instrument Panel (Copilot) .....	67
5.1.3. Center Console.....	68
5.1.4. Left Side Console.....	69
5.1.5. Left Triangular Panel .....	70
5.1.6. Left Overhead Console.....	71
5.1.7. Center Overhead Console .....	72
5.1.8. Right Overhead Console .....	73
5.1.9. Circuit Breaker Consoles .....	74
5.1.10. Right Triangular Panel .....	75
5.1.11. Right Side Console .....	76
5.1.12. Right Rear Console.....	77
5.1.13. Right Auxiliary Panel.....	78
5.2. FLIGHT CONTROLS.....	79
5.2.1. Cyclic Control System .....	79
5.2.2. Directional Control System .....	80
Tail rotor pitch limit system.....	81
Directional control system failure in flight.....	82
5.2.3. Collective Pitch Control System .....	83
5.3. POWERPLANT AND HELICOPTER SYSTEMS CONTROLS AND INDICATORS.....	85
5.3.1. ИТЭ-2Т (ITE-2T) Dual engine tachometer.....	85
5.3.2. ИТЭ-1Т (ITE-1T) Main rotor tachometer .....	85
5.3.3. ЭМИ-3РИ (EMI-3RI) Engine oil pressure/temperature gauge.....	86
5.3.4. ЭМИ-3РВИ (EMI-3RVI) Three pointer drive system oil pressure/temperature gauge .....	86
5.3.5. 2УТ-6К (2UT-6K) Power turbine inlet temperature (PTIT) gauge .....	87
5.3.6. ИР-117 (IR-117) Engine pressure ratio (EPR) indicator .....	88
5.3.7. ТУЭ-48 (TUE-48) Main transmission oil temperature gauge.....	89
5.3.8. ТВ-19 (TV-19) Cargo cabin temperature gauge .....	89
5.3.9. ТСТ-2 (TST-2) APU exhaust gas temperature (EGT) gauge .....	89
5.3.10. УИ1-3 (UI1-3) APU air pressure gauge .....	90
5.3.11. УИ1-100 (UI1-100) Hydraulic pressure gauges.....	90
5.3.12. УП-21-15 (UP-21-15) Rotor pitch indicator.....	91
5.3.13. СКЭС-2027В (CKES-2027B) Fuel quantity gauge .....	91
5.3.14. ИВ-500Е (IV-500E) Engine vibration monitor.....	91
5.3.15. МВУ-100К (MVU-100K) Pneumatic system pressure gauge .....	92
5.3.16. МА-6К (MA-6K) Brake pressure gauge .....	93
5.4. FLIGHT DATA AND NAVIGATION SYSTEMS CONTROLS AND INDICATORS.....	93
5.4.1. Pitot static system .....	93
5.4.2. УС-450К (US-450K) airspeed indicator.....	95
5.4.3. ВД-10К (VD-10K) pressure altimeter .....	95
5.4.4. ВР-30МК (VR-30MK) vertical speed indicator (VSI).....	97
5.4.5. АГБ-3К (AGB-3K) attitude indicator .....	97
5.4.6. ЭУП-53 (EUP-53) Turn and Slip indicator .....	99
5.4.7. ГМК-1А (GMK-1A) gyromagnetic compass set .....	100
5.4.8. КИ-13К (KI-13K) magnetic compass .....	102



5.4.9.	<i>AЧС-1 (AChS-1) clock</i> .....	103
5.4.10.	<i>BK-53PШ (VK-53RSh) gyro correction cutout switch</i> .....	105
5.4.11.	<i>G-load indicator</i> .....	106
<b>6.</b>	<b>RADIO COMMUNICATION AND NAVIGATION SYSTEMS</b> .....	<b>108</b>
6.1.	RADIO COMMUNICATION SYSTEMS .....	108
6.1.1.	<i>СПУ-7 (SPU-7) intercommunications set (ICS)</i> .....	108
	Features of the "СПУ-РАД" (ICS-RADIO) switch.....	109
6.1.2.	<i>P-863 (R-863) VHF/UHF command radio set</i> .....	110
6.1.3.	<i>ЯДРО-1А (YaDRO-1A) HF radio set</i> .....	112
6.1.4.	<i>P-828 (R-828) LVHF FM transceiver set</i> .....	115
6.1.5.	<i>PI-65 (RI-65) audio warning system</i> .....	118
6.2.	RADIO NAVIGATION SYSTEMS .....	119
6.2.1.	<i>АРК-9 (ARK-9) automatic direction finding (ADF) set</i> .....	120
6.2.2.	<i>АРК-УД (ARK-UD) VHF homing set</i> .....	123
6.2.3.	<i>ДИСС-15 (DISS-15) doppler navigation set</i> .....	128
6.2.4.	<i>PB-5 (RV-5) radar altimeter set</i> .....	136
6.2.5.	<i>Special purpose radio systems (UV-26 EW countermeasures system)</i> .....	138
	Components.....	138
	YB-26 (UV-26) control panel .....	139
<b>7.</b>	<b>SYSTEMS OF HELICOPTER</b> .....	<b>142</b>
7.1.	ELECTRICAL POWER SUPPLY SYSTEM.....	142
7.1.1.	<i>Primary Power Sources</i> .....	142
7.1.2.	<i>Secondary Power Sources</i> .....	144
	Single-Phase 115 VAC System.....	144
	Single-Phase 36 VAC System.....	144
	27 VDC System.....	144
7.1.3.	<i>Electrical Power Supply System Control</i> .....	145
	DC Power Control .....	146
	AC Power Control.....	147
7.1.4.	<i>Normal operation</i> .....	148
7.1.5.	<i>Failures</i> .....	148
7.2.	FUEL SYSTEM.....	150
7.2.1.	<i>Fuel Storage Location</i> .....	151
7.2.2.	<i>Fuel Distribution System</i> .....	151
	Function of Fuel System Units.....	153
7.2.3.	<i>Monitoring and Control of Fuel System Operation</i> .....	155
	Fuel System Units Control.....	155
	Fuel System Operation Monitoring .....	156
7.2.4.	<i>Normal Operation</i> .....	157
	Before Start.....	157
	Operation in Flight .....	158
7.2.5.	<i>Failures</i> .....	158
	Failure of service fuel cell float valve (not implemented).....	158
	Failure of One/Both Transfer Pump .....	159
	Service fuel cell Backing Pump Failure .....	159
7.3.	HYDRAULIC SYSTEM.....	160
7.3.1.	<i>Brief Description</i> .....	160
	Main Hydraulic System .....	161
	Backup Hydraulic System.....	161
	Control of Hydraulic Systems .....	161
7.3.2.	<i>Normal Operation</i> .....	163
	Check before starting the engine.....	163
	During Engine Start.....	163
	Hydraulic System Check During Power Plant Warm-up .....	164
7.3.3.	<i>Failures</i> .....	164
7.4.	ANTI-ICE SYSTEM .....	165

7.4.1.	<i>General Description</i> .....	165
7.4.2.	<i>Heated Glasses</i> .....	165
	Wipers .....	166
7.4.3.	<i>Anti-Ice System of air inlet Particle Separator System</i> .....	167
7.4.4.	<i>Rotors Anti-Ice System</i> .....	171
7.4.5.	<i>Ice Detectors</i> .....	172
7.4.6.	<i>Control of Anti-Ice System</i> .....	173
7.4.7.	<i>The effect of Anti-Ice System system on the flight characteristics</i> .....	176
	Maximum takeoff weight .....	176
	Fuel consumption .....	176
7.5.	PNEUMATIC SYSTEM .....	176
	Normal Operation .....	179
7.6.	FIRE PROTECTION SYSTEM .....	179
7.6.1.	<i>Brief Description</i> .....	179
7.6.2.	<i>Fire detection and alarm system</i> .....	180
	Fire detection system .....	180
	Fire alarm system .....	181
7.6.3.	<i>Indication and alarm system check</i> .....	183
7.6.4.	<i>Fire extinguishing system</i> .....	185
7.6.5.	<i>Normal Operation</i> .....	186
	Operating Conditions (stages) and required actions .....	186
	The system operation and crew procedure with fire protection equipment in case of fire .....	187
7.7.	ENVIRONMENTAL AND HEATING SYSTEM .....	188
7.7.1.	<i>Brief description</i> .....	188
7.7.2.	<i>Enabling the KO-50 heater in automatic mode</i> .....	191
7.7.3.	<i>Enabling the KO-50 heater in manual mode</i> .....	191
7.7.4.	<i>Using the KO-50 heater in ventilation mode</i> .....	191
7.7.5.	<i>Switching OFF the KO-50 heater</i> .....	191
7.8.	LIGHTING EQUIPMENT .....	192
7.8.1.	<i>Exterior lighting equipment</i> .....	192
	FPP-7M search/landing light.....	193
	FR-100 taxi light .....	196
	MSL-3 anti-collision light.....	196
	Navigation lights .....	197
	OPS-57 Formation lights .....	199
	Blade tip lights.....	200
7.8.2.	<i>Interior lighting equipment</i> .....	200
	Cockpit illumination.....	200
	Illumination of cargo cabin and technical compartments .....	205
	In-helicopter light signalization system.....	205
7.9.	REGISTRATION OF THE FLIGHT PARAMETERS AND VOICE RECORDING .....	208
7.9.1.	<i>SARPP-12DM flight data recorder</i> .....	208
7.9.2.	<i>P-503B voice recorder</i> .....	210
7.10.	SLING LOAD EQUIPMENT .....	211
7.10.1.	<i>General description</i> .....	211
7.10.2.	<i>Cargo hook controls</i> .....	212
	Automatic opening.....	213
	Manual cargo release .....	213
7.11.	АП-34Б (AP-34B) AUTOPILOT SYSTEM .....	214
7.11.1.	<i>General description</i> .....	214
	AP-34B autopilot system specifications: .....	215
7.11.2.	<i>Autopilot system's unit</i> .....	215
7.11.3.	<i>Autopilot controls and indicators</i> .....	216
	Control panel.....	216
	ИИ-4 (IN-4) zero indicator .....	217
7.11.4.	<i>Equipment interacting with the autopilot system</i> .....	218
7.11.5.	<i>Use of autopilot in different flight phases</i> .....	219
7.11.6.	<i>Explanations of the AP-34B peculiarities and key commands</i> .....	220



Combined operation of hydraulic boosters and the AP-34B autopilot in case of manual control .....	220
Game peculiarities, when pedals are used and "НАПРАВЛЕНИЕ" (YAW) channel is engaged.....	221
Trimmer features when autopilot is engaged.....	221
Positions of Cyclic and zero indicators on IN-4 during Hover and Level fligh (Roll-Pitch channel) .....	222
AP-34B Key Commands .....	224
7.12. EXHAUST IR SUPPRESSION DEVICES .....	224
<b>8. OPERATING LIMITS AND RESTRICTIONS .....</b>	<b>227</b>
8.1. CALCULATING MAXIMUM TAKEOFF WEIGHT .....	227
8.2. CALCULATING FLIGHT RANGE, RADIUS, AND TIME.....	231
8.3. ENGINES AND TRANSMISSION LIMITS .....	235
8.3.1. Engines limits.....	235
8.3.2. Transmission limits.....	238
<b>9. NORMAL PROCEDURES .....</b>	<b>240</b>
9.1. PREFLIGHT COCKPIT CHECK.....	240
9.1.1. Simplified procedure.....	240
9.1.2. Full procedure .....	241
9.2. PREPARATION AND EQUIPMENT CHECK PROCEDURES PRECEDING APU START .....	242
9.2.1. Simplified procedure.....	242
9.2.2. Full procedure .....	244
Connection of power supplies .....	244
Equipment preparation and check procedures, continued .....	246
9.3. STARTING THE APU AND MAIN ENGINES.....	246
Final procedures before APU start .....	247
Starting the AI-9v APU .....	248
Starting the TV3-117VM Main Engines .....	251
Immediately after starting the engine .....	254
9.4. ENGINES WARM UP, FLIGHT CONTROLS AND HYDRAULIC SYSTEMS CHECKS .....	255
9.5. ENGINE RUN UP, SWITCHING ON GENERATORS AND RECTIFIERS. AVIONICS CHECKS .....	256
A. Switching ON generators and rectifiers .....	256
B. Avionics check .....	260
9.6. ENGINE SHUTDOWN .....	263
In preparation for idle power setting: .....	263
engines idle power and stop: .....	265
9.7. PREPARING FOR TAXI AND TAXIING .....	268
9.8. HOVER .....	269
9.9. SHIFTS AND HOPS AT LOW ALTITUDE .....	269
9.10. TAKEOFF.....	270
Vertical takeoff with acceleration in ground effect .....	270
Vertical takeoff with acceleration out of ground effect .....	271
Running takeoff.....	271
Running nose wheel takeoff.....	272
9.11. CLIMB TO ALTITUDE.....	273
9.12. LEVEL FLIGHT.....	274
9.13. TRANSITIONAL MANEUVERS.....	274
9.14. DESCENT .....	275
Power-on vertical descent.....	275
Power-on gliding descent.....	275
9.15. AUTOROTATION DESCENT.....	276
9.16. LANDING .....	276
Vertical landing from a hover in ground effect .....	277
Vertical landing from a hover out of ground effect .....	277
Power-on running landing.....	277
Single engine landing .....	278
9.17. SEARCH AND RESCUE (SAR) OPERATIONS .....	279
9.18. FLIGHT (HOVER) OVER FEATURELESS TERRAIN USING THE DOPPLER NAVIGATION SYSTEM .....	280
9.19. NIGHT OPERATIONS IN VISUAL METEOROLOGICAL CONDITIONS (VMC).....	280
9.20. DAY OR NIGHT OPERATIONS IN INSTRUMENT METEOROLOGICAL CONDITIONS (IMC) .....	281

9.21.	WIDE RECTANGLE PATTERN .....	282
9.22.	TIGHT RECTANGLE PATTERN.....	284
9.23.	STRAIGHT IN APPROACH WITH TEARDROP PROCEDURE TURN.....	285
9.24.	SPECIAL CONSIDERATIONS FOR TAKEOFF AND LANDING OPERATIONS AT HIGH ALTITUDES .....	287
9.25.	TAKEOFF AND LANDING ON AN INCLINE .....	288
<b>10.</b>	<b>EMERGENCY PROCEDURES.....</b>	<b>290</b>
10.1.	SINGLE ENGINE FAILURE .....	290
10.1.1.	<i>Crew actions in case of a single engine failure at an altitude above 100 m:.....</i>	<i>290</i>
10.1.2.	<i>Crew actions in case of a single engine failure at an altitude below 100 m.....</i>	<i>291</i>
10.2.	DUAL ENGINE FAILURE (AUTOROTATION LANDING) .....	292
10.2.1.	<i>Crew actions in case of dual engine failure at an altitude above 100 m:.....</i>	<i>292</i>
10.2.2.	<i>Crew actions in case of dual engine failure at an altitude of 100 m and below.....</i>	<i>293</i>
10.3.	ONBOARD FIRE.....	294
10.3.1.	<i>Crew actions in case of onboard fire:.....</i>	<i>294</i>
10.4.	ENGINE MALFUNCTION .....	295
10.4.1.	<i>Automatic Control System Malfunction.....</i>	<i>295</i>
10.4.2.	<i>Abnormal Engine Vibration.....</i>	<i>296</i>
10.4.3.	<i>Low Engine Oil Pressure .....</i>	<i>296</i>
10.4.4.	<i>Failure of electronic engine governor (EEG) power turbine channels.....</i>	<i>296</i>
10.4.5.	<i>Failure of electronic engine governor (EEG) .....</i>	<i>297</i>
10.5.	MAIN/INTERMEDIATE/TAIL ROTOR GEAR BOX MALFUNCTION.....	297
10.6.	YAW CONTROL FAILURE .....	298
10.7.	HYDRAULIC SYSTEM FAILURE .....	298
10.7.1.	<i>Failure of main hydraulic system .....</i>	<i>298</i>
10.7.2.	<i>In case of failure of both main and backup hydraulic systems .....</i>	<i>299</i>
10.8.	UNCOMMANDED LEFT YAW DURING TAKEOFF OR LANDING .....	299
10.8.1.	<i>During a hover check before takeoff.....</i>	<i>299</i>
10.8.2.	<i>During a hover before landing.....</i>	<i>299</i>
10.9.	VORTEX RING STATE (VRS).....	300
<b>11.</b>	<b>ARMAMENT SYSTEMS .....</b>	<b>303</b>
11.1.	EXTERNAL WEAPON STATIONS .....	305
11.2.	CIRCUIT BREAKERS AND SWITCHES OPERATING WEAPONS INDICATION AND CONTROL SYSTEMS.....	305
11.3.	PILOT'S UPPER AND LOWER ARMAMENT CONTROL PANELS .....	307
11.3.1.	<i>Upper armament Control Panel .....</i>	<i>307</i>
11.3.2.	<i>Lower armament Control Panel .....</i>	<i>309</i>
11.4.	BOMBS CONTROL PANEL.....	312
11.5.	ЭСБР-3П/А (ESBR-3P/A) ELECTRICAL RELEASE CONTROL BOX.....	314
11.6.	PKV COLLIMATING SIGHT.....	315
11.7.	WEAPONS FIRE AND BOMB RELEASE SWITCHES.....	320
11.8.	AKS-2 GUN CAMERA .....	320
11.9.	WEAPON SYSTEMS.....	322
11.9.1.	<i>Unguided rocket system .....</i>	<i>323</i>
	Purpose .....	323
	Components.....	323
	Description.....	324
11.9.2.	<i>UPK CANNON SYSTEM.....</i>	<i>326</i>
	Purpose .....	326
	Components.....	326
	Description.....	327
11.9.3.	<i>GUV universal gun or grenade launcher container systems.....</i>	<i>328</i>
	Purpose .....	328
	Components.....	328
	Description.....	329
	Limitations .....	332
11.9.4.	<i>Weapon, installed in the cargo cabin .....</i>	<i>333</i>



Purpose .....	333
Components.....	333
General description .....	334
Implementation of the 12.7-mm KORD machine gun in the game .....	336
<b>11.9.5. Bomb delivery system.....</b>	<b>337</b>
Purpose .....	337
Components.....	337
Description.....	338
<b>12. WEAPONS EMPLOYMENT .....</b>	<b>341</b>
12.1. PREPARING THE MODULE FOR COMBAT DEPLOYMENT.....	341
12.1.1. <i>Selecting helicopter's payload in the mission editor.....</i>	<i>341</i>
12.1.2. <i>Snapviews creation for simplifying interaction with cockpit objects while playing mission</i>	<i>342</i>
12.2. THE PECULIARITY OF PILOTING WITH EXTERNAL PAYLOADS.....	342
12.3. WEAPON'S SUBSYSTEM ENABLING PROCEDURES.....	342
12.3.1. <i>To deploy rockets from the B8V20 launcher.....</i>	<i>343</i>
12.3.2. <i>To deploy UPK-23-250 23-mm gun container.....</i>	<i>346</i>
12.3.3. <i>To deploy the 12.7-mm (7.62-mm) machine guns and 30-mm grenade launchers from GUV-1</i>	<i>349</i>
12.3.4. <i>To deploy machine guns in cargo cabin .....</i>	<i>354</i>
12.3.5. <i>To deploy bomb armament.....</i>	<i>354</i>
12.4. ENABLING THE EQUIPMENT DURING COMBAT DEPLOYMENT .....	359
12.4.1. <i>Before taxi (takeoff) .....</i>	<i>359</i>
12.4.2. <i>The required PKV elevation angles for various weapons and attack profiles.....</i>	<i>362</i>
12.4.3. <i>Attack run.....</i>	<i>366</i>
12.4.4. <i>Exiting the attack .....</i>	<i>369</i>
12.4.5. <i>Firing the 12.7-mm KORD and 7.62 PKT machine guns.....</i>	<i>370</i>
Control of AI-gunners.....	370
First person playing with the 12.7-mm KORD machinegun.....	371
Use of head tracking devices (of TrackIR type) while playing as a gunner .....	372
Key commands for playing as a gunner.....	373
12.5. EMERGENCY JETTISON OF BOMBS AND STORES .....	373
12.5.1. <i>General descriptions .....</i>	<i>373</i>
Cases, when all stores must be jettisoned .....	373
12.5.2. <i>Emergency jettison procedure for the pilot.....</i>	<i>375</i>
12.5.3. <i>Emergency jettison procedure for the co-pilot.....</i>	<i>377</i>
<b>13. SPECIAL TASKS .....</b>	<b>381</b>
13.1. SLING LOAD OPERATIONS .....	381
13.1.1. <i>Game features, related to sling load operations.....</i>	<i>381</i>
13.1.2. <i>How to prepare a flight mission with a sling load.....</i>	<i>386</i>
Placing cargo on map and adjustment of the sling length .....	386
Creation of the unhook zone.....	389
13.1.3. <i>Playing with sling loads.....</i>	<i>390</i>
Cargo selection.....	390
Hovering and hooking up the load .....	392
Take off with a sling load .....	393
Flight to designated area (drop zone) .....	393
Approach and hover over the drop zone, cargo unhook.....	393
13.1.4. <i>Informational help to player, related to sling load operations .....</i>	<i>394</i>
13.1.5. <i>Keyboard commands, related to sling operations.....</i>	<i>394</i>
<b>14. HOW TO PLAY .....</b>	<b>397</b>
14.1. GENERAL INFORMATION .....	397
Interaction between player and virtual cockpit.....	397
14.2. BUILT-IN MISSIONS .....	398
Procedure for built-in mission start: .....	398

14.3.	CONTROLLING THE HELICOPTER AND INTERACTING WITH COCKPIT OBJECTS IN THE GAME.....	399
14.3.1.	<i>Controlling aircraft (airplane or helicopter) with help of a joystick.....</i>	400
14.3.2.	<i>Controlling helicopter with keyboard.....</i>	400
14.3.3.	<i>Interacting with cabin objects with the mouse .....</i>	401
14.4.	CONTROLLING VIRTUAL PILOT HEAD POSITION AND VIEWS IN THE 6DOF COCKPIT .....	401
14.4.1.	<i>Controlling virtual pilot head position in the 6DOF cockpit.....</i>	401
	Head movement, rotation and image zooming with keyboard and mouse.....	402
14.4.2.	<i>Controlling views in the 6DOF cockpit.....</i>	404
14.5.	SPECIAL SETTINGS OF THE MODULE.....	406
14.6.	ADDITIONAL PROPERTIES OF THE AIRCRAFT IN THE DCS:MI-8MTV2 .....	407
14.7.	KNEEBOARD.....	409
14.8.	USE OF AI CREW MEMBERS ASSISTANCE .....	411
14.8.1.	<i>Autopilot adjustment by the AI crew chief.....</i>	411
14.8.2.	<i>Commands, given by the AI crew chief, while playing with sling loads.....</i>	412
<b>15.</b>	<b>ABBREVIATIONS &amp; TERMS .....</b>	<b>414</b>
<b>16.</b>	<b>THE METRIC SYSTEM AND EQUIVALENTS, CONVERSION FACTORS .....</b>	<b>423</b>
16.1.	THE METRIC SYSTEM AND EQUIVALENTS.....	423
16.2.	<i>Approximate Conversion Factors .....</i>	424
<b>17.</b>	<b>DEVELOPERS .....</b>	<b>426</b>
	<i>BELSIMTEK.....</i>	426
	<i>Management.....</i>	426
	<i>Documentation.....</i>	426
	<i>Programmers .....</i>	426
	<i>Sounds .....</i>	426
	<i>Designers .....</i>	426
	<i>Tester staff.....</i>	426
	<i>Mission and campaign .....</i>	427
	<i>Voices recording for campaign .....</i>	427
	<i>Training missions .....</i>	427
	<i>Special thanks.....</i>	427
<b>18.</b>	<b>BIBLIOGRAPHY AND SOURCES.....</b>	<b>430</b>



**Important notice!**

This document includes the history of the helicopter and provides brief descriptions of the helicopter's structural elements, systems, equipment and their corresponding cockpit controls.

NOTE that the information about individual systems is not concentrated in a single section, but scattered all over the document, i.e. elements of the helicopter are described in one section of this manual while the controls and features of operation are described in another section. For example, the description of the armament system is divided in two parts: in the first part, the designation, composition and functional features are described. In the second part, information on how to use each weapon system for its corresponding tasks is given. This approach is used due to multiple interconnections between the elements of the helicopter. For this reason, a system is first described as an element of helicopter design and then as an object of cockpit control.

If you are willing to get a deeper understanding of the design and features of the Mi-8MTV2, we recommend that you carefully study all the available references.

Notes in small print are more detailed explanations for users who want to gain a deeper understanding of a mechanism, system or equipment.

In case you want to jump right into the action and start with combat employment while studying the helicopter gradually "on the go", you can begin by reading the [NORMAL PROCEDURES](#) or [WEAPONS EMPLOYMENT](#) chapters first.

For convenience, this manual contains [cross-references](#) and [hyperlinks](#) that connect all references to the same object throughout the text, or when it is necessary to describe the operation of an object in conjunction with another one. To follow a hyperlink in this PDF document, click it with the left mouse button. Use the keys **[Alt + <-]** (arrow left) or **[Alt + ->]** (arrow right) to return.

If you are a new player just getting acquainted with DCS World, it is recommended to visit the [HOW TO PLAY](#) section first.



**1**

***MI-8 HISTORY***

## 1. MI-8 HISTORY

In the late 1950s, Mikhail Mil, then chief design engineer of the OKB-329 experimental design bureau, began to consider the development of a second generation of light and medium class helicopters to be powered by gas turbine powerplants to replace the previous Mi-1 and Mi-4 models, which were then in serial production. Single and twin-engine designs were envisioned to replace the Mi-1 and Mi-4, respectively.



**Fig. 1.1. Mi-4, the precursor to the Mi-8**

At the preliminary design phase, the new helicopter was proposed as a further modification of the Mi-4 to be powered by a gas turbine powerplant. The main and tail rotors, tail boom and stabilizer, transmission, landing gear, control system and many other components were kept almost unchanged. The forward and mid fuselage were redesigned: the powerplant was moved to the top of the cargo cabin and the cockpit took the place of the Mi-4's engine compartment at the front of the fuselage. The fuselage was redesigned to increase passenger and cargo capacity. The helicopter was designed to carry oversized equipment or up to 20 passengers. In addition to basic civilian and military personnel carrying models, combat transport, anti-submarine and VIP models were planned.

On the insistence of the Soviet Ministry of Civil Aviation, the Council of Ministers of the USSR decreed on February 20, 1958, that a helicopter designated as the V-8 shall be developed to provide a cargo lifting capacity of 1.5 - 2 tons, powered by a single AI-24 gas turbine engine originally designed by A. Ivchenko for fixed-wing aircraft. About a year later, the V-8 project also gained the support of the Soviet Air Force command. Development of the V-8 was headed by deputy chief design engineer V. Kuznetsov. G. Remezov was appointed as the lead engineer (later he was followed by V. Nikiforov). In 1959, after approval of the concept design and full-scale mock-up, the team proceeded with detailed design of a single-engine V-8 model.

The AI-24V engine produced 1900 horsepower, which allowed the V-8 to retain the transmission of the Mi-4. However, performance of the AI-24V, especially specific fuel consumption requirements, was short of expectations. Furthermore, the



designers felt a need to move to a safer and more reliable twin-engine design. Several aircraft engine design bureaus were tasked with creating a 1250 horsepower turboshaft engine. The engine design challenge was taken with enthusiasm by a young experimental design bureau, OKB-117, headed by chief designer S. Izotov. This same team was also assigned the development of a new twin-shaft main transmission. The resulting increase in overall output of the powerplant provided a greater lifting capacity for the new helicopter. The contractor approved the proposed design and on May 30, 1960, a decision was made to build a twin-engine V-8A demonstrator in parallel with the single-engine V-8.

During the concept and detailed design phases, engineers of the Mil design bureau improved not only the transmission, but also other components and systems of the V-8. For example, the quadricycle landing gear was replaced by a tricycle system with a castering nose gear, hydraulic vertical hinge friction dampers were integrated in the main rotor assembly, the alcohol-based anti-icing system was replaced by an electric heating system; the hydraulic actuators of all four control channels were to be installed as a single hydraulic unit, the control system was enhanced with trimmers and artificial feel mechanisms, the landing gear and vertical stabilizer were covered with aerodynamic fairings, etc. The designers planned to retrofit most of their novelties on the Mi-4 as well to maximize commonality between existing and new helicopter models. Gradually Mikhail Mil and his team were moving from a deep upgrade of the Mi-4 to a conceptually new and promising helicopter design.

For the first time the fuselage was designed with die forgings and weld-bonded joints. The nose section featured a comfortable and unrestrictive cockpit providing an excellent view and a battery compartment underneath the floor. The helicopter had a crew of three: commander ("pilot"), navigator ("copilot"), and flight engineer ("crew chief").

The central fuselage featured a 5.34 x 2.34 x 1.8 m cargo cabin ending with rear clamshell doors, the engine and gearbox compartments placed on top, and a service fuel tank to serve as the main fuel source for the powerplant. The cargo cabin of the V-8 was designed to transport cargo and equipment with an overall weight of up to 2 tons. For rescue missions, the helicopter was equipped with a 150 kg capacity hoist, mounted outside and above the passenger cabin access door. To transport oversized cargo, an original hinge-pendulum external stores support system was developed with a carrying capacity of 2500 kg. The engine and gearbox cowlings allowed maintenance personnel to inspect all of the components in the upper part of the helicopter without using ladders. Two main fuel tanks were attached externally on both sides of the fuselage with steel straps. The tail boom featured a horizontal stabilizer, the deflection angle for which was preset on the ground.

The single-engine V-8 made its maiden flight on June 24, 1961, piloted by B. Zemskov. In December of the same year, the first V-8 was presented for joint state trials. However, the single-engine V-8 was not fated to be the prototype for the future serial production model and from 1963 onward it was only used as a testbed. The manufacturer and contractor would place their stakes on the twin-engine design. Assembled in November 1961, the second prototype of the single-engine V-8 was



used for ground tests only and became the original conversion airframe into the twin-engine V-8A model.

The new TV2-117 turboshaft engines and the VR-8 main transmission developed by S. Izotov's team were manufactured in the summer of 1962. The engines developed a takeoff power rating of 1500 horsepower each and demonstrated impressive performance characteristics. The twin-engine powerplant provided a sufficiently high power-to-weight ratio to allow the helicopter to maintain level flight with one engine inoperative. The VR-8 was a three-stage planetary reduction gear with a transmission ratio of 1:62.6.

On August 2, 1961, test pilot N. Levshin lifted the twin-engine version off the ground for the first time and on September 17 the helicopter performed its first untethered flight. In March 1963, the V-8A proceeded to the first phase of joint state trials, which were generally successful, although at times flights were suspended and the helicopter was grounded to address defects or retrofit equipment. In the summer of 1963, trials were suspended for nearly two months while additional work was done on the engines and main transmission.

The design of the prototype was continually modified, over time resembling its Mi-4 predecessor less and less. In particular, a new five-blade main rotor was created to reduce the intensity of vibrations. The blades were of solid metal construction like those of the Mi-4, but some of the joints were reinforced. A new electric anti-icing system was installed. The original wooden tail rotor blades were replaced with all-metal blades. Monotube landing gear struts were replaced with twin-tube oleo struts that eliminated the likelihood of dynamic instability. The design of the tail strut was also changed. The landing gear and wheels were covered with fairings. An automatic flight control system centered on a four-channel AP-34 autopilot system was introduced into the control system and significantly improved handling.

As development tests and improvements continued, the new powerplant was equipped with an automatic governor system that adjusted engine power output as required to maintain main rotor speed (RPM) within normal limits and synchronized the operation of the two engines. In case of a single engine failure in flight, the system automatically commanded the remaining engine to increase power.

All of the improvements were quickly implemented on the third prototype in the process of assembly. This prototype was built as a troop carrying version and was designated V-8AT. It featured twenty folding seats arranged along the walls inside the cargo cabin. Meanwhile the mockup was used to test the loading and securing of various types of combat and engineering equipment, as well as fitting of an armament system identical to that of the Mi-4AV. The external appearance of the V-8AT was somewhat altered compared to the V-8A: side cockpit doors were replaced with sliding blisters and a sliding door was implemented in the cargo cabin.

Assembly of the V-8AT prototype was completed in the summer of 1963 and it replaced the V-8A in joint state trials, while the latter continued to be used for flight and ground fatigue tests. During flight testing on April 19, 1964, the test crew commanded by B. Koloshenko set two world records on the V-8AT: a closed circuit distance record (2465.7 km) and a 2000 km straight course speed record (201.8

km/h). Later, in the period of 1967-1969, crews commanded by I. Kopets and I. Isaeva would set five female world records on the Mi-8.

In May, 1964, assembly of the passenger V-8AP model was completed, featuring a VIP cabin for official use. It was almost identical to the V-8AT and became the testbed for tests of an upgraded AP-34B autopilot system and main rotor speed synchronizer. The same year in September, test flights of the V-8AP initiated the second phase of joint state trials. One month later, the V-8AT joined this test phase. The helicopters demonstrated excellent characteristics. In November 1964, the acceptance committee made a decision to recommend the helicopter for serial production and its troop carrying version was approved for military service.

In the winter of 1964-1965, the V-8AP was converted into a standard passenger version with 20 upholstered seats, coat stowage, thermal and sound insulation, heating, ventilation, air conditioning, and some interior styling. In March 1965, tests at the GosNIIGA research facility were completed and the passenger version was recommended for serial production for use by the Aeroflot state airliner. When the helicopter entered serial production, the troop transport version was designated as Mi-8T and the passenger version as Mi-8P. By the end of 1965, the Kazan assembly plant produced the first serial airframes. The serial production Mi-8T differed from the prototype in having circular windows in the cargo cabin. The rectangular windows were kept on the Mi-8P and its future modifications.

In 1968, the armed Mi-8TV model completed testing. The Mi-8TV featured an external weapons assembly with two hardpoints on each side of the fuselage designed to carry UB-16-57 rocket launchers armed with KARS-57 (S-5) unguided rockets or 50 to 500 kg free-fall bombs. The designers had planned to add a cockpit operated machine gun mount in the nose of the helicopter, but had to forego this in favour of allowing a higher bomb payload.

When armament tests were completed in 1968, the Mi-8T light troop transport helicopter was officially accepted for service by the Soviet Air Force. By this time, the helicopter's major parts had accumulated a 1000-hour service life. For its wonderful performance characteristics, handling, and ease of flight and maintenance operations, personnel transitioning from the Mi-4 to the Mi-8 dubbed the new helicopter "Vasilissa the Beautiful".

By 1969, the Mi-8 completely replaced the Mi-4 on the production line. Its production rates grew year by year reaching several hundred helicopters per year. From 1965 to 1996, the Kazan Helicopter Plant manufactured, in different modifications, a total of four and a half thousand Mi-8s powered by TV2-117 engines. In 1970, the Ulan-Ude Helicopter Plant started production of the Mi-8 in parallel with Kazan. To date this facility has produced more than 3700 Mi-8s powered by TV2-117 engines.

Designs of the helicopter's component systems were continually improved throughout its lifespan. Engineers of the Mil Moscow Helicopter Plant together with their colleagues from Kazan and Ulan-Ude significantly improved the design and extended the service life of the helicopter's systems. The service life of modern Mi-8 models exceeds 20000 hours. In 1980, the Mi-8 obtained its first airworthiness certificate under American FAR-29 standards to allow operations in Japan. Between

1970s and 1990s, Mi-8s were equipped with efficient mast-mounted vibration dampers, weather radar, a sling load system (in place of the earlier hinge-pendulum system) with a 3 ton lifting capacity, battle damage tolerance was improved, armouring added, armament enhanced, various equipment was repeatedly upgraded, etc. Meeting demands by the Polish Ministry of Defense, a version with 37 troop seats was developed. The improvements to helicopter components were not made by the Soviet engineers alone, but also by some foreign operators. For example, Egyptian airframes were equipped with a British particle separator system ("dust protectors") and Finland installed a navigation radar on their machines. In the second half of the 1980s, a series of experimental research efforts were conducted by the Moscow Helicopter Plant for the purpose of improving the helicopter's aerodynamic performance – external fuel tanks were removed, new cargo doors installed, swashplate and exhaust nozzle fairings added, etc.

Upgrades to the powerplant played a key role in further improving helicopter performance. Soon after launching serial production, helicopters were equipped with improved TV2-117A engines. Starting in 1973, airframes delivered to southern hemisphere countries were equipped with a special modification of the engine designed for operations in hot weather conditions. By the late 70s, an enhanced performance TV2-117F engine model was developed, producing 1700 horsepower in emergency power mode. This engine was installed on the Mi-8PA model. In the 1980s, the TV2-117A engine was replaced by the higher lifespan TV2-117AG, which featured carbon seals in the turbo compressor assembly supports. Helicopters equipped with this engine were again designated as Mi-8AT and are used to this day as a basis for the development of different new, mainly civilian, modifications. Mi-8ATs equipped with relatively low-cost TV2-117AG engines are widely used in areas of flat terrain and moderate air temperatures. In 1987, the Mi-8TG prototype model was created to test the TV2-117TG engine, for the first time in the world fuelled by liquid methane. To enhance powerplant reliability, particle separator systems of various designs were developed. The so-called "mushroom" type separators were eventually preferred, entering serial production and first being fielded in 1977.

A critical event in the Mi-8 development history was the upgrade of the powerplant to a more powerful engine. By the late 60s, S. Izotov's team in Leningrad had developed the TV3-117 engine, which produced 1900 horsepower. A version of this engine was also planned to be installed on the Mi-24 gunship helicopter as the designers focused on maximizing commonality in the powerplants, transmission, and rotors on all three production helicopter types.

In 1971, the TV2-117 engines and transmission of the Mi-8T were replaced by TV3-117MT engines, a new VR-14 main gearbox and a reinforced transmission. The upgraded helicopter was also equipped with the AI-9 auxiliary power unit (APU) with a starter generator, and a redesigned tail rotor. The tail rotor design was changed from a "pushing" to a "pulling" rotor. This change, where the lower blade now moved towards instead of away from the main rotor downwash, combined with increased tail rotor blade chord, significantly improved yaw control.

The Mi-4 began to be withdrawn from service in the early 1970s, but the TV2-117 powered Mi-8 was not yet able to completely replace it for "hot and high" operations.

The designers had to work fast provide a solution. An upgraded helicopter was built by the summer of 1975 and performed its maiden flight on August 17 of the same year. Flight tests demonstrated a significant improvement in performance, in particular in ceiling and climb rate. The number of weapons stations was increased from two to three on each side. The helicopter was approved for military service and designated as Mi-8MT, entering serial production at the Kazan Helicopter Plant in 1977. Starting the following year, it was built with the upgraded TV3-117MT Series III engines. Initially the production rate of TV3-117-powered helicopters was considerably lower than that of previous models, but the war in Afghanistan demanded a revision of the order portfolio and by the mid-80s, the Mi-8MT and its modifications dominated the assembly lines. From 1977 to 1997, the Kazan Helicopter Plant produced more than 3500 helicopters with TV3-117MT and TV3-117VM engines.

In 1981, the Mi-8MT debuted at the Paris air show. For promotional reasons it was designated Mi-17, which became its export designation on the world market. A passenger version, in its interior styling similar to the Mi-8P, was designated Mi-17P. The basic Mi-8MT model, like its predecessor, gave rise to numerous civilian and military variants.

The next important step in the evolution of the Mi-8 was equipping it with high-altitude TV3-117VM engines, the first prototypes of which were tested in 1985. It took the Mikhail Mil Design Bureau two years to create the new Mi-8MTV model (and its export version, Mi-17-1V). A high-altitude engine allowed the helicopter to take off and land at altitudes of up to 4000 m and maintain level flight at 6000 m. In addition to a higher ceiling, other characteristics were also improved: climb rate, range, etc. The new model included advanced equipment such as weather radar, a long range radio navigation system, armouring, self-sealing fuel tanks with a urethane foam filler, nose and tail PKT machine gun mounts, six external weapons stations and cabin gun mounts for the troops. Having analyzed the experience in Afghanistan, the designers enhanced the durability of helicopter parts and components. To improve operational safety, the Mi-8MTV was equipped with an emergency ditching system. The Mi-8MTV (Mi-8MTV-1) entered serial production in 1988. The basic model is available in transport, troop transport, air assault, ambulance, and ferry versions, as well as fire support and a minelaying modifications.

In 1991, the Mi-8MTV also entered serial production at the Ulan-Ude Helicopter Plant with some minor equipment modifications designated Mi-8AMT (Mi-171). This helicopter is produced in transport, troop transport, ambulance, and passenger versions. The Mi-171A obtained a type certificate in Russia in 1997. In 1999, the passenger and cargo versions of the Mi-171 obtained a type certificate in China under American FAR-29 standards for operations over land and water.

Following the Mi-8MTV-1 (Mi-17-1V), the Kazan Helicopter Plant received new Mi-8MTV-2 and Mi-8MTV-3 model specifications in the 1990s. These increased the number of transportable troops to 30, featured better armouring and upgraded systems. For the Mi-8MTV-3, only four of six weapons stations were kept, but the number of supported payload combinations (profiles) was increased from 8 to 24.

The chord of the tail rotor blades was increased and tail rotor control cables reinforced. A rope deployment system for assault troops was added, as well as a higher capacity hoist. In 1991, the Mi-8MTV-3 became the prototype for the Mi-172 export model, which became certified by the Indian aviation register under American FAR-29 standards in 1994. In Russia, it was certified as the Mi-172A.

In 1992, all of the improvements were integrated in a new demonstrator model, the Mi-17M. The latter also had an international navigation system and improved radar, bigger side doors, rear cargo doors similar to those of the Mi-26 (utilizing smaller doors and a folding ramp). Under a contract with a Canadian company, a Mi-17KF joint modification was created featuring a western avionics suite and a glass cockpit design.

In 1997 in Kazan, the Mi-17M demonstrator became the basis for a new basic model: Mi-8MTV-5 (Mi-17V-5). The new model features an improved layout and airframe structure, including an additional passenger/troop access door on the right side of the cargo cabin and a wider left door. The clamshell rear cargo doors are replaced by a hydraulically actuated ramp, and the number of troop seats is increased to 36. Troops can now egress from the helicopter in three directions through the two doors and the ramp in just 15 seconds. The wider left door also made it possible to fit a new rescue hoist with a 300 kg lifting capacity, allowing it to lift up to three people simultaneously. A large hatch in the floor allows for use of an external stores support system with a 4.5 ton carrying capacity. The nose section is completely redesigned, featuring a nose fairing to cover a weather radar and new radio equipment (resulting in the distinctive "dolphin-nosed" namesake of this model variety). The Mi-8MTV-5 also features an upgraded navigation system. The cockpit is adopted for night-vision goggles, so the helicopter can be used in any time of the day in all seasons and in a broader range of weather conditions. The design of other equipment has also been improved, in particular the electrical power system, which now features new brushless generators.

Information for this history chapter taken from publications of the Mikhail Mil Moscow Helicopter Plant (<http://www.Mi-Helicopter.Ru>).





**2**

***GENERAL DESIGN  
AND PURPOSE***

## 2. GENERAL DESIGN AND PURPOSE

### 2.1. Helicopter dimensions

Length:	
nose to vertical fin trailing edge	18.424 m
with turning (main and tail) rotors	25.352 m
Height:	
without tail rotor	4.756 m
with turning tail rotor	5.321 m
Ground clearance at lowest point of fuselage	0.445 m
Horizontal stabilizer surface area	2.0 m <sup>2</sup>
Cargo cabin interior dimensions:	
length (floor)	5.34 m
width	2.3 m
height	1.8 m
Clamshell door clearance	
height	1.620 m
width (at waterline)	2.288 m
Sliding door clearance:	
height	1.405 m
width	0.825 m
Main rotor:	
diameter	21.294 m
number of blades	5
direction of turn	forward, right, back
Tail rotor:	
type	universal joint
diameter	3.908 m
direction of turn	down, forward, up
number of blades	3
Tail rotor blade pitch ( $R = 0.7$ ):	
minimum (full left pedal)	$-6^{\circ} + 1^{\circ}10'$ $-50'$
maximum (full right pedal)	$+23^{\circ} + 30'$ $-15'$
Landing gear:	
type	tricycle, non-retractable
main wheel track	4.510 m
wheel base	4.281 m
Wheel dimensions:	
nose wheels	595 x 185 mm
main wheels	865 x 280 mm
Static ground angle (forward and up)	$4^{\circ}10'$
Tail strut	shock absorbing

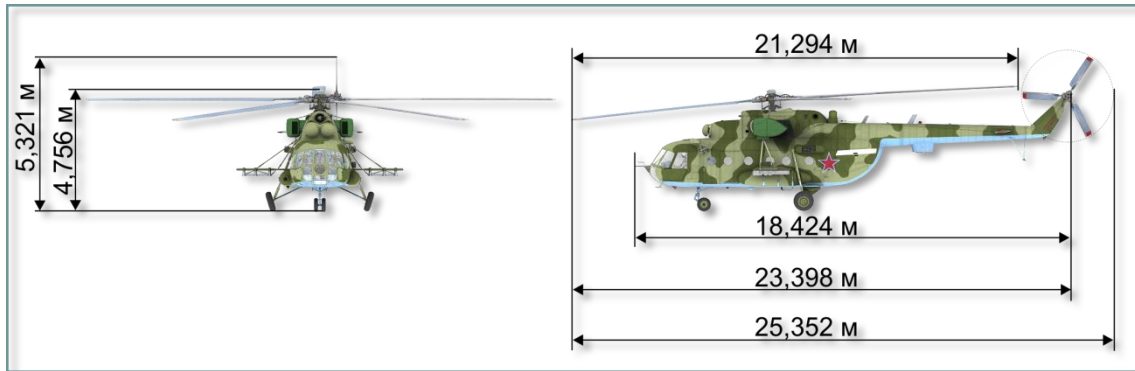

Fig. 2.1. Mi-8 dimensions

## 2.2. Performance specifications

Normal takeoff weight	11100 kg
Maximum takeoff weight	13000 kg
Cargo capacity:	
normal	2000 kg
maximum (with full main fuel tanks)	4000 kg
troops	21-24
medical stretchers	12
Maximum level flight speed at altitudes 0 – 1000 m:	
normal takeoff weight	250 km/h
maximum takeoff weight	230 km/h
Cruising speed at altitudes 0 – 1000 m:	
normal takeoff weight	220-240 km/h
maximum takeoff weight	205-215 km/h
Hover ceiling with normal takeoff weight OGE (standard atmosphere)	3960 m
Service ceiling:	
normal takeoff weight	5500 m
maximum takeoff weight	3900 m
Time required to reach altitude at nominal engine power and ideal climbing speed (120 km/h), anti-icing system disabled:	
normal takeoff weight	
1000 m	1.8 <sup>+0,5</sup> min
3000 m	6 <sup>+1</sup> min
4000 m	9.5 <sup>+2</sup> min
maximum takeoff weight	
1000 m	2.4 <sup>+0,5</sup> min
3000 m	10.9 <sup>+1</sup> min
Service range at an altitude of 500 m and cruising speed with full main fuel tanks before 5% fuel reserve reached:	
cargo load 2117 kg	495 km
cargo load 4000 kg	465 km
one full internal auxiliary fuel tank	725 km
two full internal auxiliary fuel tanks (ferry range)	950 km

### ***2.3. Purpose and missions***

The Mi-8MTV2 is designed to enhance mobility of ground forces and provide fire support on the battlefield.

The primary missions performed by the helicopter include:

- tactical air assault
- air mobility of ground forces
- transport of internal and external cargo
- destruction of ground targets in the forward edge of the battle area (FEBA) and within tactical depth, such as: infantry, lightly armored vehicles, anti-tank positions, artillery positions, surveillance and reconnaissance positions, air defense positions, forward command posts, helicopters and other aircraft positioned on the ground
- destruction of deployed hostile airborne (naval) assault forces
- support (escort) of friendly airborne assault forces to the deployment area and subsequent combat support
- airborne reconnaissance
- airborne minelaying
- search and rescue operations
- medical evacuation
- search and destruction of air reconnaissance balloons

The Mi-8MTV2 can be configured as follows to meet mission requirements:

#### 1. Transport:

- no auxiliary fuel tanks (internal cargo capacity up to 4000 kg)
- single auxiliary fuel tank (cargo cabin)
- two auxiliary fuel tanks (cargo cabin)
- transport of external load up to 3000 kg

#### 2. Air assault:

- transport up to 24 armed troops

#### 3. Medevac:

- up to twelve patients on stretchers plus medical assistant
- mixed configuration (up to 20 men – 3 stretchers and 17 seats or 15 seats and one auxiliary fuel tank)

#### 4. Airborne minelaying:

- equipped with VSM-1 minelaying system

#### 5. Combat support (up to six B8-V20A rocket launchers or bombs, cannon pods, GUV universal machine gun or automatic grenade launcher pods)

#### 6. Ferry configuration

To facilitate transportation of special and oversize cargo (such as main rotor blades) as well as parachute jump training, the rear cargo clamshell doors can be maintained partially open or removed entirely.

The Mi-8MTV2 is capable of operating in day or night time conditions, visual or instrument meteorological conditions, from prepared or unprepared airfields.

The helicopter crew consists of three crew members: pilot, copilot, and crew chief.





**3**

***HELICOPTER AERODYNAMICS***

## 3. HELICOPTER AERODYNAMICS

### 3.1. General principles

If developing vertical flight had been as simple as the idea itself, the helicopter would have undoubtedly been the first practical aircraft. In its earliest form, the helicopter was conceived by Leonardo da Vinci in the early 1500's. In his notes, da Vinci used the Greek word "helix", meaning a spiral, and combined this word with the Greek word "pteron", meaning wing. It is from this combination of Greek words that our word helicopter is derived.

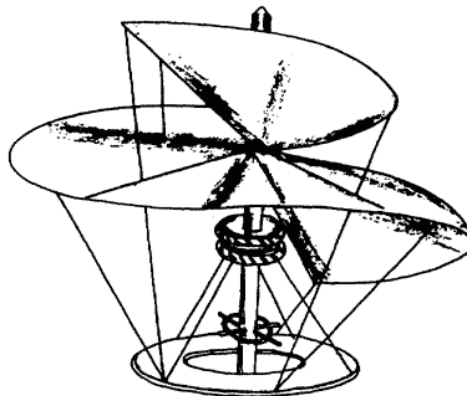

Fig. 3.1. Da Vinci sketch of the Helixpteron

Development proved too difficult and complicated for the early experimenters, because they did not have an engine of sufficient power to ensure flight. When larger, lighter, and more reliable engines were developed hundreds of years later, the dream of a helicopter became a reality.

The same laws of force and motion that apply to fixed wing aircraft also apply to helicopters. Helicopter controls are complex; torque, gyroscopic precession, and dissymmetry of lift must be dealt with. Retreating blade stall also limits a helicopter's forward airspeed.

This chapter provides a basic explanation of helicopter controls, velocity, torque, gyroscopic precession, dissymmetry of lift, retreating blade stall, settling with power, pendular action, hovering, ground effect, translational lift, and autorotation.

#### ***Forces acting on a helicopter***

Weight ( $G$ ) and drag ( $Q$ ) act on a helicopter as they do on any aircraft; however, lift ( $T_y$ ) and thrust ( $T_x$ ) for a helicopter are obtained from the main rotor ( $T_{rotor}$ ). In a very basic sense, the helicopter's main rotor does what wings and a propeller do for a fixed-wing aircraft. Moreover, by tilting the main rotor, the pilot can make the helicopter fly to either side, forward, or backwards.

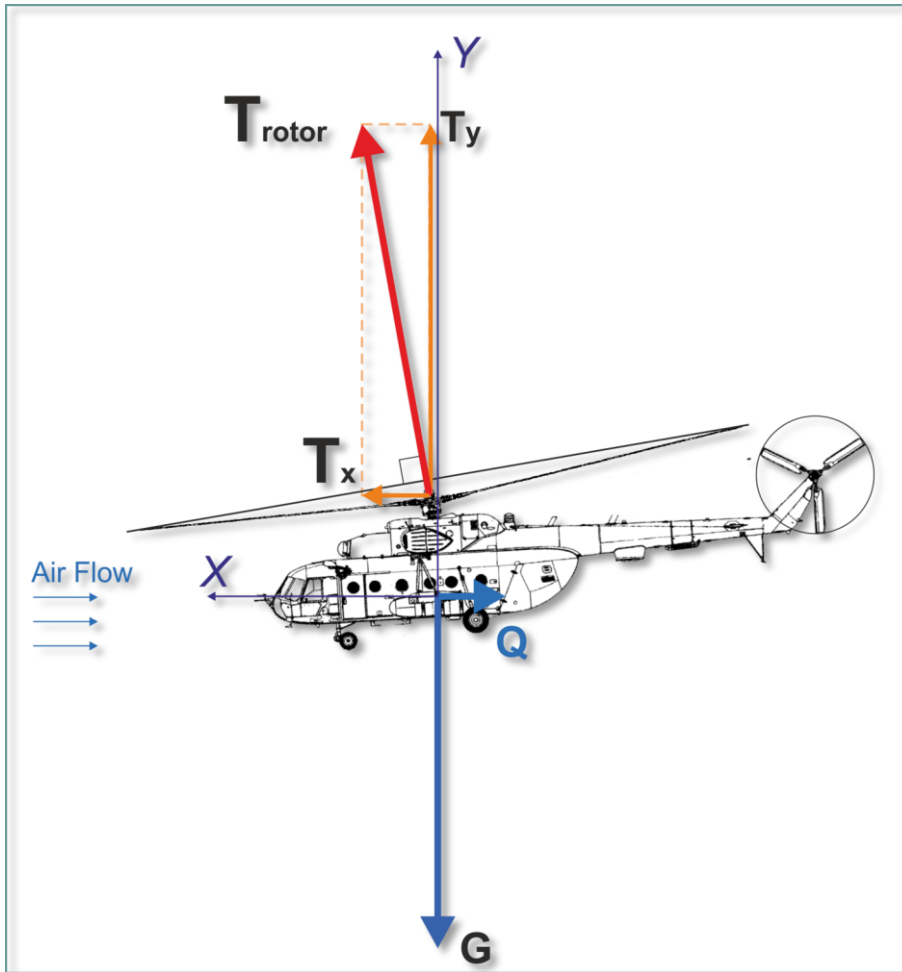
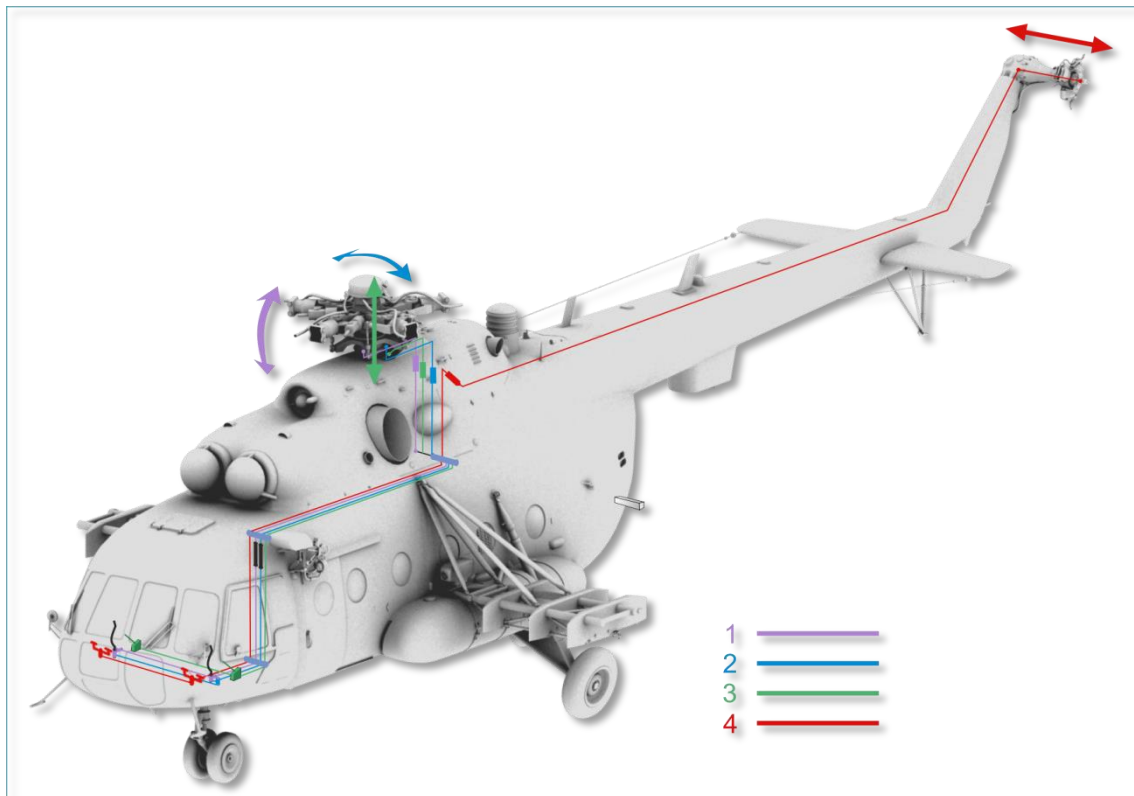

Fig. 3.2. Forces acting on a helicopter

**CONTROLS****Fig. 3.3. Helicopter controls**

1. Longitudinal cyclic control: moving the cyclic control stick forward/backward tilts the main rotor disc forward/backward and causes the helicopter to pitch down/up
2. Lateral cyclic control: moving the cyclic control stick left/right tilts the main rotor disc left/right and causes the helicopter to roll left/right
3. Collective pitch control: moving the collective lever up/down increases/decreases the pitch angle of all main rotor blades equally and causes an increase/decrease of main rotor thrust (ascend/descend)
4. Yaw control: applying the anti-torque pedals left/right makes the nose yaw in the direction of the applied pedal and the tail yaw right/left

The sketch in [Fig. 3.3](#) shows the main rotor, cyclic and collective, anti-torque pedals, and anti-torque (tail) rotor. Basically, the cyclic control is a mechanical linkage used to change the pitch of the main rotor blades. Pitch change is accomplished at a specific point in the plane of rotation to tilt the main rotor disc. Most current military helicopters now have hydraulic assistance in addition to the mechanical linkages. The collective changes the pitch of all the main rotor blades equally and simultaneously. The anti-torque pedals are used to adjust the pitch in the anti-torque rotor blades to compensate for main rotor torque.

**Velocity**

A helicopter's main rotor blades must move through the air at a relatively high speed in order to produce enough lift to raise the helicopter and keep it in the air. When

the main rotor reaches required takeoff speed and generates a great deal of torque, the anti-torque rotor can negate fuselage rotation.

The helicopter can fly forward, backward, and sideways according to pilot control inputs. It can also remain stationary in the air (hover) with the main rotor blades developing enough lift to hover the helicopter.

### ***Torque***

The torque problem is related to a helicopter's single-main-rotor design. The reason for this is that the helicopter's main rotor turns in one direction while the fuselage wants to turn in the opposite direction. This effect is based on Newton's third law that states "To every action there is an opposite and equal reaction." The torque problem on single-rotor helicopters is counteracted and controlled by an anti-torque (tail) rotor.

On coaxial helicopters, the main rotors turn in opposite directions and thereby eliminate the torque effect.

### ***Anti-torque rotor (tail rotor)***

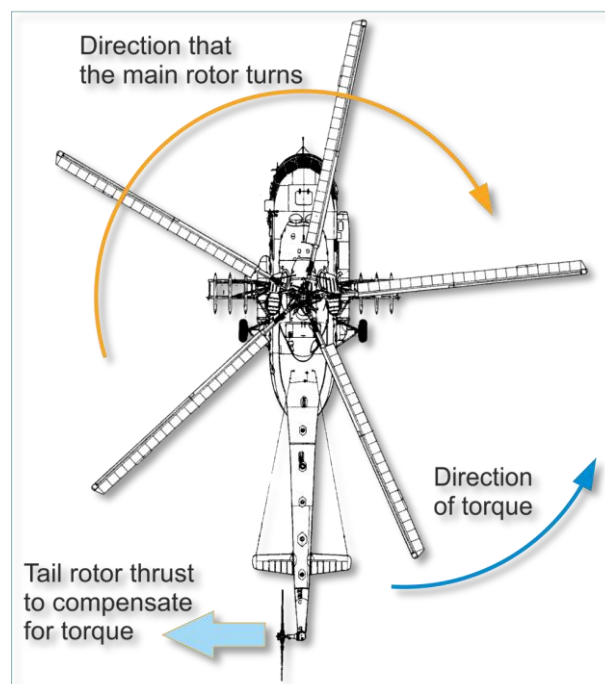

**Fig. 3.4. Tail rotor and thrust**

[Fig. 3.4](#) shows the direction of travel of the main rotor, the direction of torque of the fuselage, and the location of the anti-torque (tail) rotor.

An anti-torque rotor located on the end of a tail boom provides torque compensation for single-main-rotor helicopters. The tail rotor, driven by the engine at a constant speed, produces thrust in a horizontal plane opposite to the torque reaction developed by the main rotor.



### ***Gyroscopic precession***

Controlling the rotor lift vector through gyroscopic precession is only applicable for rotor systems utilizing a single blade hinge.

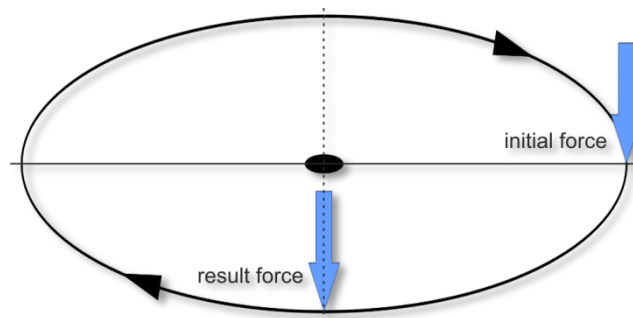

**Fig. 3.5. Gyroscopic precession**

The result of applying force against a rotating body occurs at 90° in the direction of rotation from where the force is applied. This effect is called gyroscopic precession and it is illustrated in [Fig. 3.5](#). For example: if a downward force is applied at the 3 o'clock position in the diagram, then the result appears at the 6 o'clock position as shown. This will result in the 12 o'clock position tilting up an equal amount in the opposite direction.

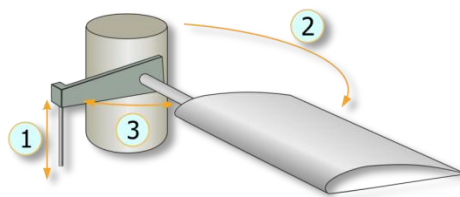

**Fig. 3.6. Offset control linkage**

- |  |   |
|--|---|
| 1. Direction of control link input and cyclic blade pitch adjustment<br>2. Direction of blade turn | 3. 90 degree position ahead of the current blade position |
|--|---|

[Fig. 3.6](#) illustrates the offset control linkage needed to tilt the main rotor disc in the direction the pilot inputs with the cyclic. If such a linkage were not used, the pilot would have to move the cyclic 90° ahead of the desired direction along the direction of turn. For example, to move the helicopter forward, he would need to move the stick to the left. The offset control linkage is attached to a lever extending 90° in the direction of rotation from the main rotor blade.

### ***Dissymmetry of lift***

The area within the circle made by the rotating blade tips of a helicopter is known as the disc area or rotor disc. When hovering in still air, lift generated by the rotor blades is equal within all parts of the disc. Dissymmetry of lift is the difference in lift that exists between the advancing half of the disc and the retreating half; this is created by horizontal flight and/or wind.

When a helicopter is hovering in still air, the tip speed of the advancing blade is approximately 600 feet per second ( $\sim 183$  m/s) and the tip speed of the retreating blade is the same. Dissymmetry of lift is created by the movement of the helicopter in forward flight. The advancing blade has the combination of blade speed velocity and that of the helicopter's forward airspeed. The retreating blade however loses speed in proportion to the forward speed of the helicopter.

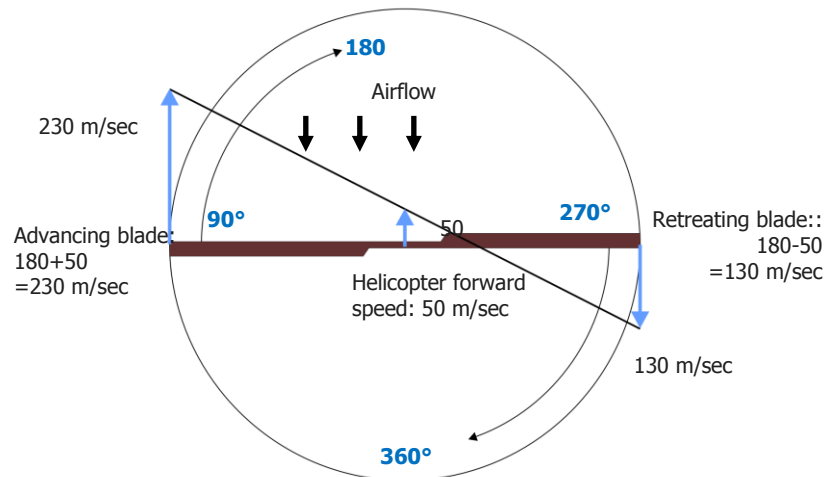

**Fig. 3.7. Dissymmetry of lift: (ROTATIONAL VELOCITY)  $\pm$  (HEL FORWARD SPEED) = (AIRSPEED OF BLADE)**

[Fig. 3.7](#) illustrates dissymmetry of lift and shows the arithmetic involved in calculating the differences between the velocities of the advancing and retreating blades. In the figure, the helicopter is moving forward at a speed of 50 m/s, the velocity of the rotor disc is equal to approximately 180 m/s, and the advancing blade speed is 230 m/s. The speed of the retreating blade is 130 m/s. This speed is obtained by subtracting the speed of the helicopter (50 m/s) from the tip speed of 180 m/s. As can be seen from the difference between the advancing and retreating blade velocities, a large speed and lift variation exists.

Cyclic pitch control, a design feature that permits changes in the angle of attack during each revolution of the rotor, compensates for the dissymmetry of lift. As the forward speed of the helicopter is increased, the pilot must apply more and more cyclic to hold a given rotor disc attitude. The mechanical addition of more pitch to the retreating blade and less to the advancing blade is continued throughout the helicopter's range.

### ***Retreating blade stall***

Retreating blade stall is the tendency of a helicopter's retreating blades to stall in forward flight. This is a major factor in limiting a helicopter's maximum forward airspeed. Just as the stall of a fixed wing aircraft wing limits the low-air-speed flight envelope, the stall of a rotor blade limits the high-speed potential of a helicopter. The airspeed of a retreating blade slows down as forward airspeed is increased. The retreating blade must produce an amount of lift equal to that of the advancing blade. As the airspeed of the retreating blade is decreased with forward airspeed, the blade angle of attack must be increased to equalize lift throughout the rotor disc area. As

this angle of attack is increased, the blade will eventually stall at some high, forward airspeed as shown in [Fig. 3.10](#).

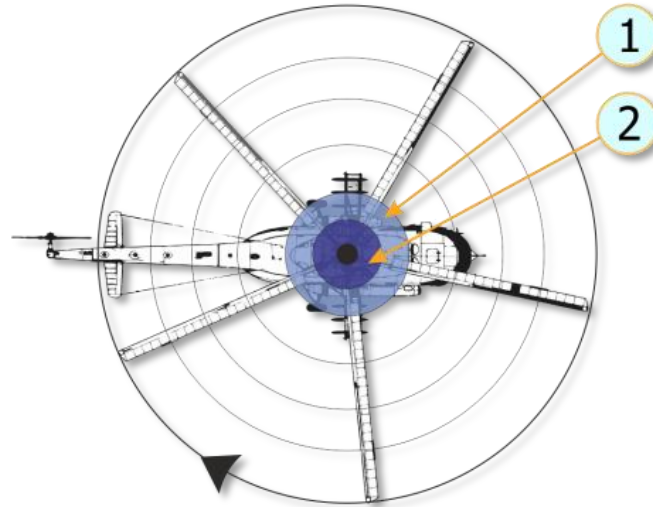

**Fig. 3.8. Hovering lift pattern**

1. No lift area

2. Blade root area

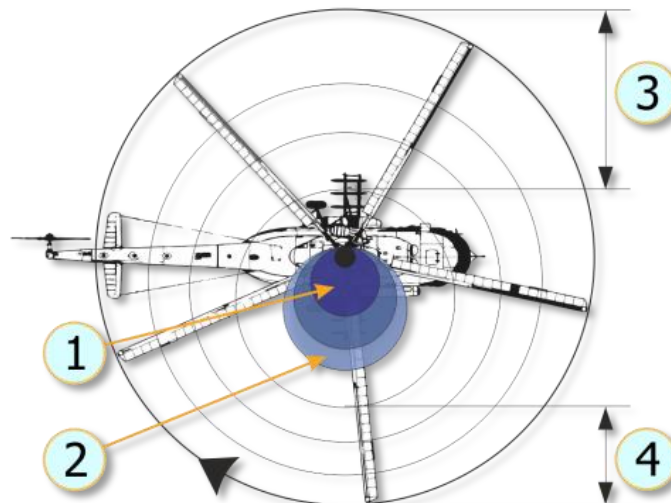

**Fig. 3.9. Normal cruise lift pattern**

1. Reverse airflow area

2. No lift area

3. Lift produced in this area requires low blade angle of attack

4. Lift produced in this area requires greater blade angle of attack (lift must equal that of zone 3)

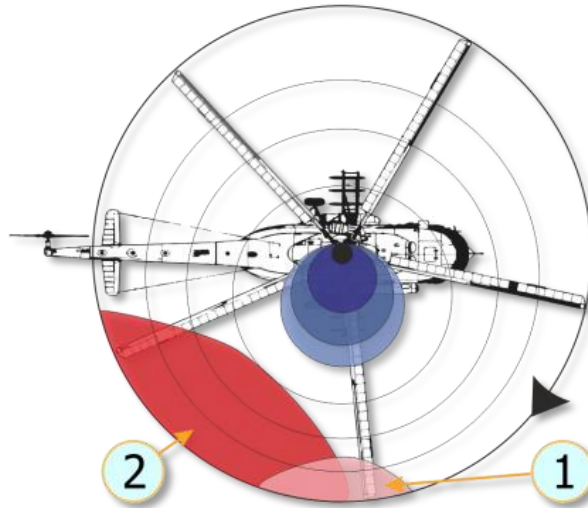

**Fig. 3.10. Lift pattern at critical airspeed**

1. Area of blade tip stall, causes vibration and buffeting

2. If blade angle of attack continues to remain high, stall area increases. The helicopter pitches up and rolls right (stalling)

Upon entry into a retreating blade stall, the first noticeable effect is vibration of the helicopter. This vibration is followed by the helicopter's nose lifting with a rolling tendency. If the cyclic is held forward and the collective is not reduced, the stall will become aggravated and the vibration will increase greatly. Soon thereafter, the helicopter may become uncontrollable.

To recover from a stall:

- reduce collective pitch
- neutralize cyclic
- reduce airspeed
- increase rotor RPM

### ***Settling with power (Vortex Ring State)***

Settling with power is a condition of powered flight when the helicopter settles into its own main rotor downwash; this is also known as Vortex Ring State (VRS).

Conditions conducive to settling with power include a vertical, or nearly vertical, descent of at least 4 m/s with low forward airspeed. The rotor system must also be using some of the available engine power (from 20 to 100%) with insufficient power available to retard the sink rate. These conditions occur during approaches with a tailwind or during formation approaches when some aircraft are flying in the downwash of other aircraft.

Under the conditions described above, the helicopter may descend at a high rate that exceeds the normal downward induced flow rate of the inner blade sections. As a result, the airflow of the inner blade sections is upward relative to the disk. This produces a secondary vortex ring in addition to the normal tip vortex. The secondary vortex ring is generated at about the point on the blade where airflow changes from

up to down. The result is an unsteady turbulent flow over a large area of the disk that causes loss of rotor efficiency, even though power is still applied.

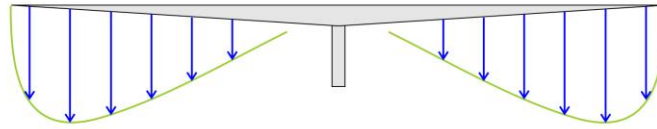

**Fig. 3.11. Induced flow velocity during hovering flight**

The downward velocity is highest at the blade tip where blade airspeed is highest. As blade airspeed decreases towards the center of the disk, downward velocity is less.

[Fig. 3.12](#) shows the induced airflow velocity pattern along the blade span during a descent conducive to settling with power.

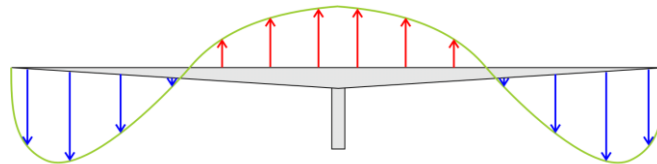

**Fig. 3.12. Induced flow velocity during Vortex Ring State**

The descent is so rapid that the induced flow at the inner portion of the blades is upward rather than downward. The upward flow caused by the descent can overcome the downward flow produced by blade rotation.

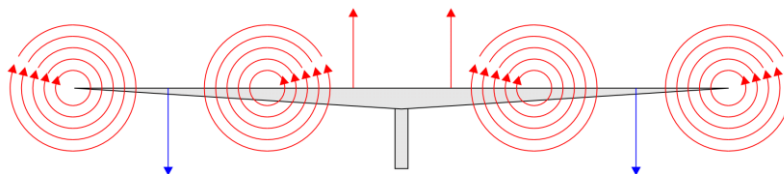

**Fig. 3.13. Vortex rotation flows along the blades during VRS**

If the helicopter descends under these conditions, with insufficient power to slow or stop the descent, it will enter a vortex ring state.

During a vortex ring state, roughness and loss of control is experienced because of the turbulent rotational flow on the blades and the unsteady shifting of the flow along the blade span.

Power settling is an unstable condition, and if allowed to continue, the sink rate will reach sufficient proportions for the flow to be entirely up through the rotors. This can result in very high descent rates. Recovery may be initiated during the early stages of power settling by putting on a large amount of excess power. This excess power may be sufficient to overcome the upward flow near the center of the rotor disc. If the sink rate reaches a higher rate, power will not be available to break this upward flow and thus alter the vortex ring state of flow.



Normal tendency is for pilots to recover from a descent by application of collective pitch and power. If insufficient power is available for recovery, this action may aggravate power settling and result in more turbulence and a higher rate of descent. Recovery can be accomplished by lowering collective pitch and increasing forward speed (pushing the cyclic forward). Both of these methods of recovery require sufficient altitude to be successful.

### ***Hover***

A helicopter hovers when it maintains a constant position over a point on the ground, usually a few feet above the ground. To hover, a helicopter's main rotor must supply lift equal to the total weight of the helicopter, including crew, fuel, and if applicable, passengers, cargo, and armaments. The necessary lift is generated by rotating the blades at high velocity and increasing the collective pitch angle of the rotor blades.

When hovering, the rotor system requires a large volume of air upon which to work. This air must be pulled from the surrounding air mass; this is an expensive maneuver that takes a great deal of engine horsepower. The air delivered through the rotating blades is pulled from above at a relatively high velocity, forcing the rotor system to work in a descending column of air.

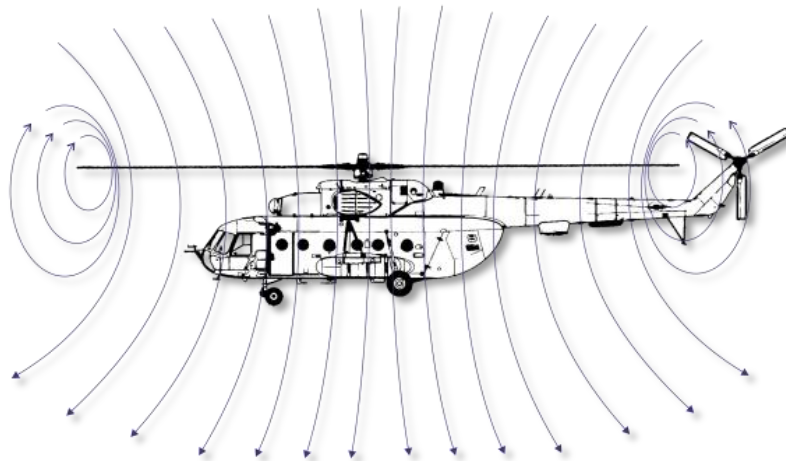
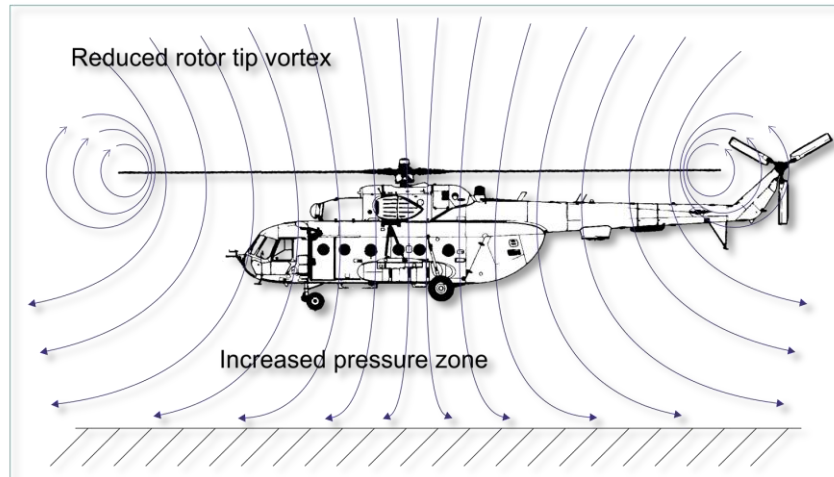

**Fig. 3.14. Airflow when out of ground effect**

The main rotor vortex and the recirculation of turbulent air add resistance to the helicopter while hovering. Such an undesirable air supply requires higher blade angles of attack and an expenditure of more engine power and fuel. Additionally, the main rotor is often operating in air filled with abrasive materials that cause heavy wear on helicopter parts while hovering in the ground effect.

### ***Ground effect***

Ground effect is a condition of improved performance found when hovering near the ground. The effect begins to occur when hovering at an altitude equal to approximately the radius of the main rotor (5-10 m for most helicopters) and increases as altitude decreases.



**Fig. 3.15. Airflow when in ground effect**

The improved lift and airfoil efficiency while operating in ground effect is due to a number of effects. First, and most importantly, the main rotor-tip vortex is reduced. When operating in the ground effect, the downward and outward airflow reduces the vortex. A vortex is an airflow rotating around an axis or center. This makes the outward portion of the main rotor blade more efficient. Reducing the vortex also reduces the turbulence caused by recirculation of the vortex.

The second important factor is a reduction in the downwash airflow velocity by the ground, which produces a zone of increased air pressure below the helicopter. This affects the rotor system and increases lift. The maximum lift coefficient produced by ground effect at zero altitude is 1.2.

### ***Translational lift***

The efficiency of the hovering rotor system is improved by each knot of incoming wind gained by forward motion of the helicopter or by a surface headwind. As the helicopter moves forward, fresh air enters in an amount sufficient to relieve the hovering air-supply problem and improve performance. At approximately 40 km/h, the rotor system receives enough free, undisturbed air to eliminate the air supply problem. At this time, lift noticeably improves and the helicopter begins to climb. This distinct change is referred to as translational lift. At the instant of translational lift, and as the hovering air supply pattern is broken, dissymmetry of lift is created. As airspeed increases, translational lift continues to improve up to the speed that is used for best climb.

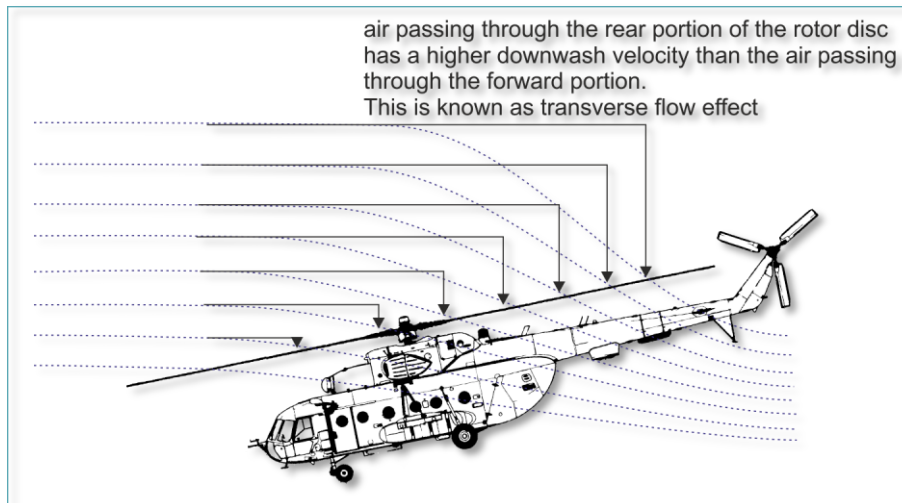
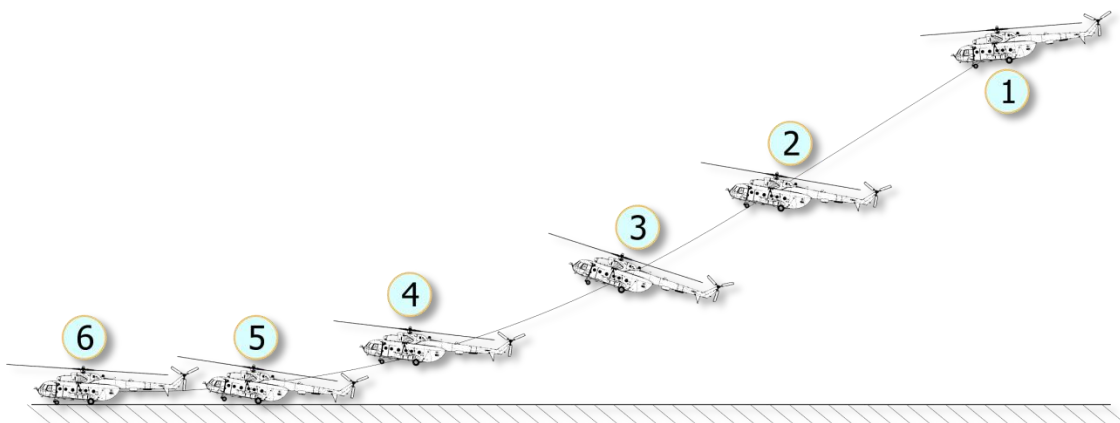

**Fig. 3.16. Translational lift**

In forward flight, air passing through the rear portion of the rotor disc has a higher downwash velocity than the air passing through the forward portion. This is known as transverse flow effect and is illustrated in [Fig. 3.16](#). This effect, in combination with gyroscopic precession, causes the rotor to tilt sideward and results in vibration that is most noticeable on entry into effective translation.

### ***Autorotation***

If engine power fails, or other emergencies occur, autorotation is a means of safely landing a helicopter. The transmission in a helicopter is designed to allow the main rotor to turn freely in its original direction when the engine stops. [Fig. 3.17](#) illustrates how the helicopter is allowed to glide to earth and by using the main rotor rpm, make a soft landing.



**Fig. 3.17. Approach to landing, power off**

1. While descending, establish 70-80 km/h IAS, lower collective to maintain safe rotor RPM (collective full down)
2. At 35-50 m altitude, increase pitch to 10 degrees above horizon
3. At 20-30 m altitude, raise collective to reduce rate of descent. This requires precise control and timing
4. At 4-6 m altitude, set landing pitch attitude
5. Landing
6. Short landing run to complete stop

In autorotation, the helicopter pilot exchanges potential energy (altitude) for kinetic energy (speed) required to maintain rotor RPM. This is accomplished by establishing a gliding descent to provide sufficient continuous airflow for the rotor system.

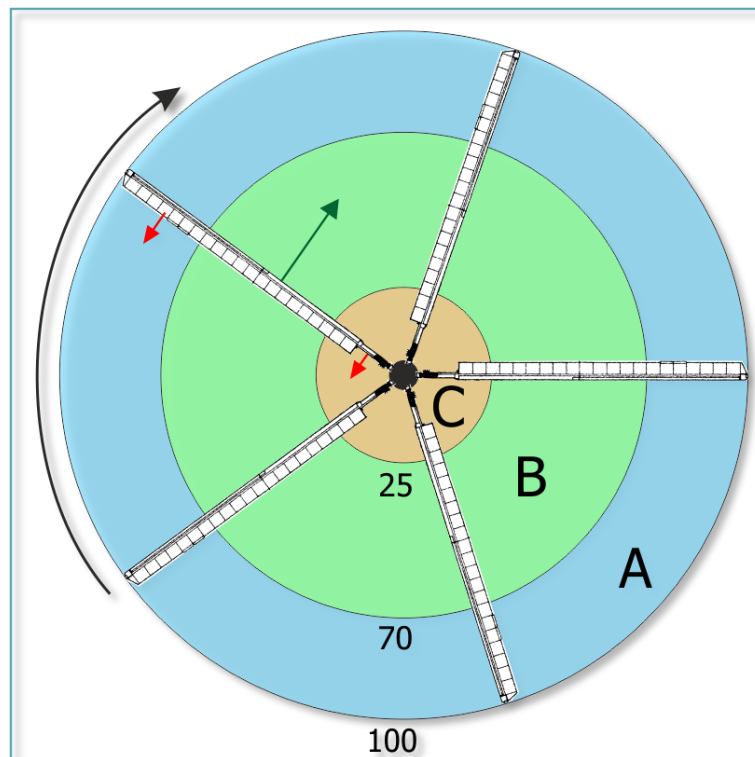

**Fig. 3.18. The rotor blade autorotative regions**

As shown in [Fig. 3.19](#), the rotor disc dynamics during autorotation can be broken into three regions: outboard, middle, and inboard.

**A:** The outboard blade area is known as the propeller or driven region. Analysis of blade region A indicates the aerodynamic force inclines slightly behind the rotating axis. This inclination causes a small drag force that tends to slow the tip portion of the blade.

**B:** The rotor blade autorotative driving region is the portion of the blade between 25 to 70 percent radius. Because this region operates at a comparatively high angle of attack, the result is a slight but important forward inclination of aerodynamic forces. This inclination supplies thrust slightly ahead of the rotating axis and tends to speed up this portion of the blade during autorotation.

**C:** The blade area inboard of the 25% circle is known as the stall region, because it operates above its maximum angle of attack. This region contributes considerable drag that tends to slow the blade.

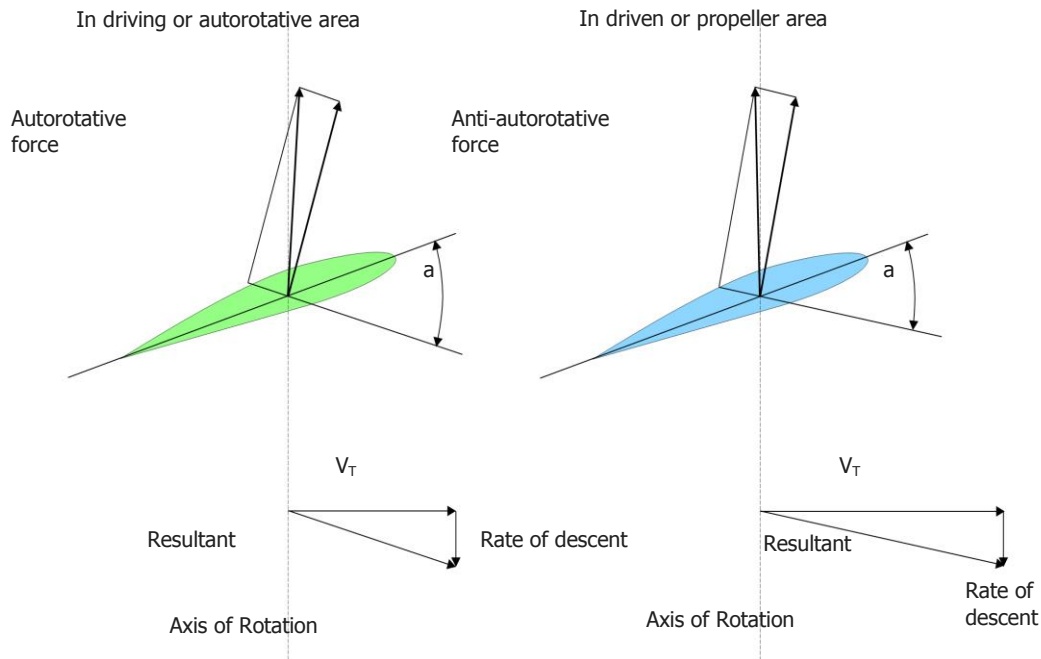
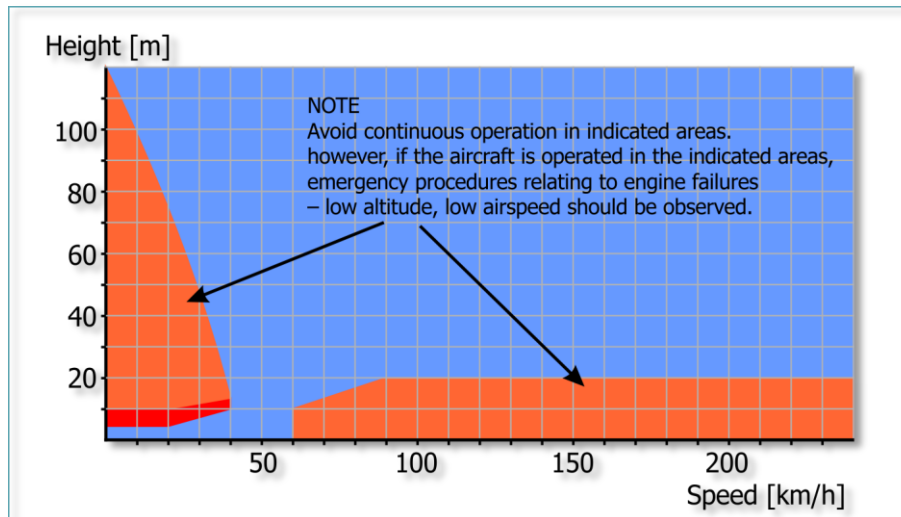

**Fig. 3.19. Autorotation blade forces**

When performing an autorotation landing, the pilot must maintain an efficient approach speed and glide slope of  $14 - 16^\circ$ . The approximate distance to the planned landing point can be estimated by multiplying current altitude by a factor of 4. Prior to touchdown, the descent rate must be arrested by increasing collective to ensure a safe landing. This "flare" requires precise timing. A useful rule of thumb is that the altitude of the flare is equal to the vertical velocity multiplied by a factor of 3 – 4. For example, if the vertical velocity equals 10 m/s, the flare is performed at an altitude of 30 – 40 meters. If the flare is particularly aggressive, the initial flare altitude must be reduced by half.

All helicopters carry an operator's manual that has an airspeed versus altitude chart similar to the one shown in [Fig. 3.20](#). The shaded areas on this chart must be avoided. This area is referred to as the "dead man's curve" and "avoid curve". The proper maneuvers for a safe landing during engine failure cannot be accomplished in these areas.





**Fig. 3.20. Height-velocity diagram**

### **Summary**

Weight, lift, thrust, and drag are the four forces acting on a helicopter. The cyclic for directional control, the collective pitch for altitude control, and the anti-torque pedals to compensate for main rotor torque are the three main controls used in a helicopter.

Torque is an inherent problem with single-main-rotor helicopters. Gyroscopic precession occurs at approximately  $90^\circ$  in the direction of rotation from the point where the force is applied. Dissymmetry of lift is the difference in lift that exists between the advancing and retreating halves of the rotor disc.

Settling with power can occur when the main rotor system is using from 20 to 100% of the available engine power, and the horizontal velocity is under 20 km/h. At a hover, the rotor system requires a great volume of air upon which to generate lift. This air must be pulled from the surrounding air mass. This is a costly maneuver that takes a great amount of engine power.

Ground effect provides improved performance when hovering near the ground at a height of no more than approximately one-half the main rotor diameter. Translational lift is achieved at approximately 20 km/h, and the rotor system receives enough free, undisturbed air to improve performance. At the instant translational lift is in effect and the hovering air-supply pattern is broken, dissymmetry of lift is created. Autorotation is a means of safely landing a helicopter after engine failure or other emergencies. A helicopter transmission is designed to allow the main rotor to turn freely in its original direction if the engine fails.

### **3.2. Mi-8MTV2 aerodynamic particulars**

The Mi-8MTV2 is a conventional helicopter with a single clockwise rotating main rotor and a single anti-torque tail rotor.

The fuselage of the helicopter is a solid-metal semi-monocoque construction with a variable cross section. It consists of the forward and central parts, tail boom and vertical stabilizer.

The horizontal stabilizer installed on the tail boom is adjusted on the ground and is non-controllable in flight. The stabilizer improves longitudinal stability and controllability, and ensures that required pitch control authority is available throughout the flight envelope.

For takeoff and landing, the helicopter is equipped with non-retractable landing gear and a tail strut. These are equipped with hydro-pneumatic shock absorbers. The tail strut prevents the tail rotor from striking the ground in case of a landing with a large positive pitch angle.

A five-blade main rotor creates the lifting force and thrust required for the helicopter to perform forward flight. Additionally, the main rotor is used to control the helicopter along the pitch and roll axes. The blades have a rectangular planform.

The tail rotor creates the side force to counter the torque from the main rotor and is used for yaw control. The three-blade tail rotor is a pulling type with variable blade pitch for yaw control. Rotation of the tail rotor is mechanically driven by the main rotor via the transmission system. The direction of rotation is forward – up – back. Tail rotor pitch is controlled from the cockpit by the anti-torque pedals operated by the pilot(s).

The helicopter is powered by two TV3-117VM turboshaft engines. From the two-stage power turbines, engine power is transmitted via two main power shafts to the main gearbox. The engines are positioned on top of the cabin in front of the main gearbox.

The helicopter has an external stores support system that allows transportation of cargo on an external sling.

These special features determine the helicopter's aerodynamic characteristics, stability and controllability.

### ***Power requirement for level flight***

The power requirements for level flight depend heavily on flight speed. Maximum power demand occurs at zero forward speed (for hovering out of ground effect) and in horizontal flight at maximum airspeed. In the speed range of 0 to 110-120 km/h, power requirements for level flight decrease as airspeed increases, but further increases of airspeed demand increasing power.

### ***Main rotor thrust***

With the PZU particle separator system switched off, the free thrust of the main rotor is 13200 kg with the engines operating in takeoff power mode (3800 hp) in standard atmosphere at sea level in calm winds. In the same conditions, in nominal engine power mode (MAX LTD CRUISE) (3400 hp), the thrust is 12040 kg. Activation of the PZU particle separator system reduces thrust by approximately 200 – 300 kg.

Main rotor thrust varies strongly depending on atmospheric conditions: free air temperature (FAT), wind speed and direction, and barometric pressure at the altitude of the airfield. This variability necessitates performing a hover safety check prior to initiating any takeoff to ensure safe flight operations. For a takeoff In Ground Effect

(IGE), the hover check is performed at 3 m above ground at airfields located at altitudes of up to 3000 m and at least 4 m above ground at airfields located at altitudes higher than 3000 m. The height of the hover safety check for a takeoff Out of Ground Effect (OGE) must be at least 10 m.

### ***3.3. Mi-8MTV2 performance particulars***

Minimum flight speed with normal takeoff weight for altitudes below 4000 m and with maximum takeoff weight for altitudes below 3000 m is 60 km/h. Maximum flight speed for altitudes below 1000 m is 250 km/h with normal takeoff weight and 230 km/h with maximum takeoff weight. The speed limit lowers as altitude increases up to the operational ceiling. Optimum climbing speeds are 120 km/h for altitudes below 2000 m and 100 km/h for altitudes of 4000 m and higher. Optimum cruising speed is 10 km/h above optimum climbing speed.

The vertical rate of climb near the ground is 9 m/s with normal takeoff weight (anti-icing system switched off) and 7 m/s with maximum takeoff weight without the external weapons stations fitted. Activation of the anti-icing system reduces rate of climb by 1 m/s.

The operational ceiling with normal takeoff weight without external station racks is 5000 (anti-icing system off) or 4900 (anti-icing system on) m. With maximum takeoff weight it is 3900 m (anti-icing system off) and 3600 m (anti-icing system on).

Activation of the PZU particle separator system reduces the rate of climb by 0.6 m/s.

Fitting of exhaust gas suppression (EGS) devices reduces the operational ceiling by 150 – 200 m and the rate of climb by 0.5 – 1 m/s.

### ***Safe altitudes and airspeeds in case of a single engine failure in flight***

In case of a single engine failure in flight, a certain time is required to detect the failure and take corrective actions. During this time, the helicopter may lose about 10 m of altitude as the automatic control system cannot set the remaining engine into takeoff power mode immediately. If the helicopter is at a low altitude and high speed at the moment of failure, required crew actions are to quickly gain altitude, establish a safe flight attitude and, if necessary, find a suitable location for an emergency landing. Altitude is gained by a 10 – 15° pitch up maneuver and deceleration of the helicopter. For example, initial level flight airspeed of 130 – 230 km/h may result in a deceleration to 80 km/h and an altitude gain of 30 – 100 m.

When performing a landing or hover approach, an altitude safety margin is required in case of an engine failure in order to provide sufficient time to perform a short ground run landing and correct any instability as a result of sudden changes in engine power output or landing gear ground contact.

### ***3.4. Mi-8MTV2 control particulars***

The kinematic connection of the cyclic control stick with the swashplate is rigged such that the neutral position of the stick corresponds to a forward-left tilt of the swashplate. This is designed to minimize cyclic stick deflection from the neutral

position in cruise flight. Similarly, the neutral position of the pedals corresponds to a positive pitch of the tail rotor blades, which allows the pilot to maintain the pedals in a position near neutral in cruise flight.

The pitch control system includes a hydraulic stop that restricts the aft deflection of the swashplate to  $2^{\circ}12'$ . Further deflection is possible only with application of greater aft cyclic stick force (about 15 kg). The hydraulic stop is activated by a weight-on-wheels microswitch and is designed to protect the tail boom from being struck by rotor blades in case of an abrupt or large pull of the cyclic control during helicopter taxi.

The yaw control system includes the SPUU-52 tail rotor pitch limit system, which maintains required yaw authority in hovering flight in varying weather conditions (temperature and pressure). In a hover, the required right pedal application reduces as ambient air pressure increases. The SPUU-52 automatically adjusts the variable stop to restrict tail rotor pitch in order to prevent overloading of the transmission or overstressing the tail boom.

### ***3.5. Mi-8MTV2 trimming and balancing***

#### ***Ground trim***

As the helicopter is initiated into motion on the ground, during taxi, ground run, and at the moments of takeoff and touchdown, conditions may develop in which the helicopter will tend to roll on its side with respect to an imaginary diagonal between the nose gear and one of the main gear wheels, a condition known as a dynamic rollover.

When positioned on the ground, the forces acting on the helicopter with running engines are gravity, main rotor thrust, tail rotor thrust and the ground reaction forces acting on the wheels. The tilting forces that may result in a dynamic rollover are tail rotor thrust, lateral components of ground reaction, lateral forces acting on the helicopter during taxi turns and, in case of incorrect pilot actions, a component of main rotor thrust. The corrective forces are the vertical components of ground reaction and, in case of correct pilot actions, a component of main rotor thrust.

As main rotor thrust increases, the vertical component of ground reaction forces is reduced and its stabilizing effect weakened. The addition of any roll angle shortens the arm of this force and further reduces its stabilizing effect. Crosswind, low stiffness of the landing gear, a high center of gravity (CG) position - all contribute to a potential dynamic rollover condition.

On a slippery or inclined surface with the main rotor turning, the helicopter may skid sideways. The likelihood of a rollover or skid increases as main rotor thrust increases.

For takeoff and landing on an incline, it is preferable to align the helicopter along the slope (nose to tail). If doing so is not possible, then the left side of the helicopter should be positioned facing the slope (so that the right side is below the left side), because tail rotor thrust tends to roll the helicopter left.

When taking off from an incline, rapidly increase collective pitch in the final phase up to the moment of takeoff; when landing, rapidly reduce collective pitch to minimize

the duration of instability on the ground. In case of a sudden roll angle increase on the ground, i.e. at the start of a dynamic rollover, either quickly reduce collective to settle the helicopter on the ground or quickly increase collective to lift the helicopter off the ground.

### ***Helicopter tendencies at liftoff***

In a vertical takeoff, increased power applied to the main rotor increases torque-induced yaw if rotor RPM is constant, resulting in a left yaw tendency.

If tail rotor thrust is not increased by right pedal application at the moment of takeoff, the helicopter yaws to the left due to torque-induced yaw.

In addition to exhibiting left yaw, at the moment of takeoff the helicopter tends to roll and drift to the left under the force of tail rotor thrust directed to the right. These tendencies are corrected by adjusting cyclic position to the right to direct the downward vector of main rotor thrust to the left to counteract tail rotor thrust.

Because the rotation axis of the tail rotor is below the plane of the main rotor hub, in a hover the helicopter is trimmed with 2 - 2.5° of roll.

When accelerating from a hover to 30 - 35 km/h, balancing the helicopter requires moving the cyclic control significantly forward. Maximum required deflection is reached at 40 km/h.

When accelerating from 40 - 45 km/h to 90 - 100 km/h, balancing the helicopter requires pulling the cyclic aft from the forward position reached during initial acceleration from a hover.

Between 100 - 130 km/h, cyclic trim is almost unchanged. As airspeed increases beyond 120 km/h, balancing the helicopter requires progressive forward cyclic. Maximum required deflection is reached at maximum airspeed.

This pattern of cyclic deflection versus airspeed is a result of the variations in pitch moments of the main rotor and the fuselage at different airspeeds.

The most significant balance shift occurs in a transition from a climb at maximum (takeoff) engine power to an autorotation glide.

Required collective pitch is reduced as airspeed increases from 0 - 100 km/h, then begins to progressively increase as airspeed increases.

### ***Roll TRIM***

In a hover, the helicopter is trimmed with 2 - 2.5° of roll with a slight right cyclic position.

Transitioning from a hover to forward flight up to maximum airspeed, the cyclic is trimmed progressively left to maintain balanced flight. Maximum left deflection is reached in a high speed autorotation glide.

### ***Yaw TRIM***

Maximum stroke travel of the tail rotor shaft (maximum right pedal application) is required in a hover as maximum engine power output is demanded.



Tail rotor efficiency increases as airspeed increases, resulting in minimum required pedal deflection in level flight at airspeeds of 170 - 180 km/h. Right pedal application increases as airspeed increases beyond 180 km/h.

In autorotation, the friction forces in the gearbox and transmission create a turning moment that acts in the direction of the main rotor rotation (clockwise). In this case, yaw trim requires left pedal application to maintain heading.

### ***Trimming in turns, spirals, and coordinated sideslips***

Increased roll angles in turns and spirals, as well as the accompanying increases in vertical G loads, require considerable pulling of the cyclic control aft. In left turns and spirals, the required pull is greater than in right turns and spirals. Reduced engine power modes reduce the required cyclic pull.

In spirals, roll and yaw trim do not change significantly.

Coordinated sideslips are executed with pedal application in the corresponding direction. Induced roll angles produced as a result of pedal application are corrected with opposite cyclic control deflection.

The Mi-8MTV2 helicopter has good static sideslip stability throughout the range of operating airspeeds. At large sideslip angles, the required opposite deflection of the cyclic to either side per unit of roll is reduced. At roll angles of 9 - 14°, the helicopter becomes statically neutral in the lateral axis.

## ***3.6. Mi-8MTV2 stability particulars***

Helicopter stability is the ability to automatically return to a steady flight attitude after an outside disturbance is neutralized. Helicopter stability can be static and dynamic.

Static stability is the ability of the helicopter to resist changes to current flight conditions (airspeed, angles of attack and sideslip).

Dynamic stability characterizes the helicopter's recovery to the reference flight condition. Dynamic stability is determined by a combination of static stability, damping characteristics, and relationship between longitudinal and lateral axes oscillations for current flight conditions.

Throughout the envelope of operating airspeeds, the Mi-8MTV2 demonstrates high static sideslip stability, but low angle of attack and airspeed static stability.

The damping characteristics of a single-rotor helicopter are much weaker than those of a fixed-wing aircraft. Besides, a helicopter has a strong dependence between the lateral-directional and longitudinal motion.

The helicopter's behaviour after a disturbance in the air has an oscillating character in terms of airspeed, bank and pitch angles. The amplitude of these parameters varies over time. Additionally, the helicopter has a slow aperiodic tendency to drift away from a trimmed flight condition. That is, like other helicopters, the Mi-8MTV2 demonstrates an acceptable dynamic instability throughout the range of airspeeds, including in hover, which is demonstrated by the relatively long duration (two and

more minutes in the air with the autopilot disengaged) that it maintains a trimmed flight condition with the flight controls released in calm atmosphere conditions before roll angle changes reach  $10^\circ$ .

When the autopilot is engaged, the stability characteristics of the helicopter improve and piloting becomes easier.

### ***3.7. Mi-8MTV2 maneuvering particulars***

The capability of the helicopter to change its attitude in space, i.e. the airspeed, altitude and flight direction, characterizes its maneuverability. To perform maneuvers on this helicopter, you need to be aware of some of its special characteristics.

#### ***Acceleration in level flight***

To accelerate, the main rotor (propulsive) thrust component directed along the flight path must be increased. To increase this force, pitch the helicopter nose down by pushing the cyclic control forward.

As the result of the increase of the tilt of the main rotor thrust together with the tilt of the helicopter, the vertical component of thrust reduces, and the helicopter tends to descend which must be compensated by increasing the collective pitch of the rotor.

To execute horizontal acceleration at maximum rate, engine power must be increased within 9-10 sec to takeoff power and helicopter pitch set to  $-15$  to  $-20^\circ$ .

While accelerating at constant engine power, maintain level flight by simultaneously reducing the helicopter pitch angle. The acceleration time at maximum rate from 60 to 220 km/h is 26 - 36 sec. The maximum possible acceleration per second is 6-9 km/h.

#### ***Deceleration in level flight***

To decelerate in level flight, increase the pitch angle of the helicopter and reduce collective pitch.

To execute a strong level flight deceleration from airspeeds close to maximum, increase the pitch angle of the helicopter by  $10 - 15^\circ$  within 8-12 sec and simultaneously reduce collective pitch in order to maintain altitude. Collective pitch should be reduced by no more than  $2.5 - 3^\circ$  on the collective pitch indicator.

During deceleration, maintain level flight by controlling the pitch angle, and when minimum speed is approached at the end of deceleration, increase engine power and reduce helicopter pitch angle. The average time of horizontal deceleration from 220 to 60 km/h at maximum rate is 28 sec.





4

***POWERPLANT AND  
DRIVE SYSTEM***



## 4. POWERPLANT AND DRIVE SYSTEM

This chapter contains descriptions about Engines And Related Systems, Auxiliary Power Unit (APU), Drive System, Air Cooling System.

### 4.1. Engines and related systems

The Mi-8MTV2 helicopter powerplant consists of two TV3-117VM turboshaft engines. The engines are installed on the fuselage deck in a common nacelle with the oil cooler fan of the air cooling system.

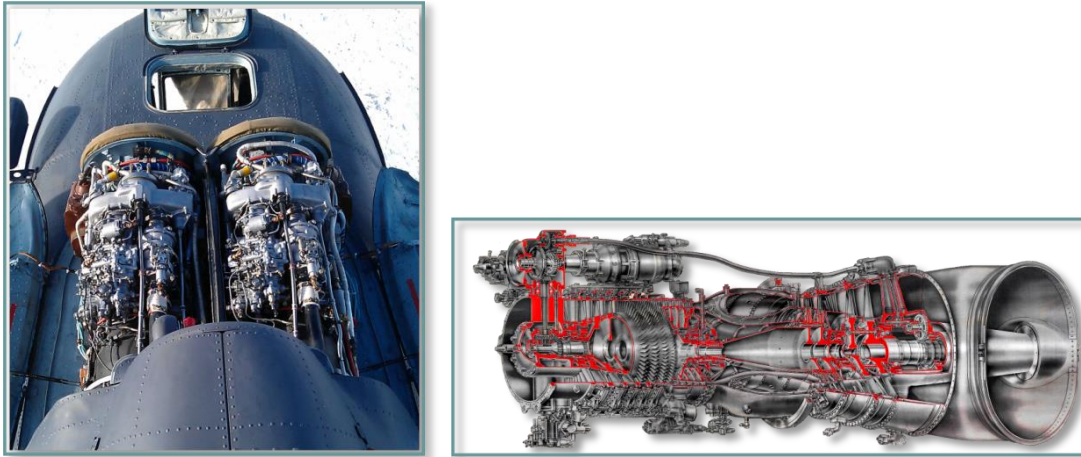

**Fig. 4.1. Engine diagram and installation on the Mi-8MTV2**

The engines are situated parallel to the helicopter's longitudinal centerline at a distance of 600 mm from each other and are tilted downward, toward the front, at an angle of  $4^{\circ}30'$  relative to the fuselage horizontal reference line. The rear output shafts of the engines are connected, via a uniball coupling, to the main transmission, which transmits power to the main rotor, AC generators, tail rotor, and accessories.

Utilizing a twin engine system increases operational safety as one engine can provide sufficient power for controlled flight in case of a single engine failure.

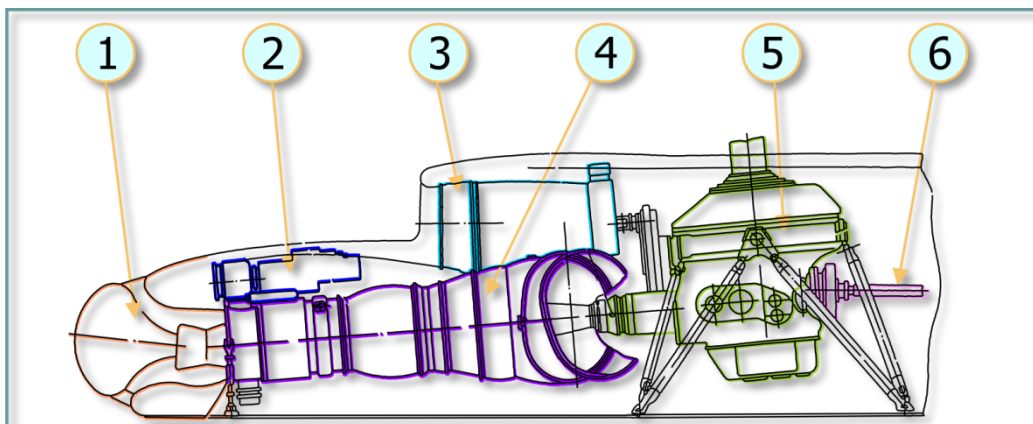

**Fig. 4.2. Powertrain system diagram (side view)**

1. Engine inlet and particle separator head ("PZU");

4. TV3-117VM engine;  
5. VR-14 main transmission;

2. Air starter and accessory gearbox;
3. Oil cooler fan;
6. Tail rotor driveshaft.

### TV3-117VM performance characteristics See in Table 4.1

**Table 4.1**

Nº	Performance characteristics	Value
1	direction of turbines rotation	Left
2	Engine Weight	285(+5.7) kg
3	Dimensions	
	length	2055 mm
	width	650 mm
	height	728 mm
4	Air temperature range which provide engine start	
	at Altitude 0 m	-60...+60°C
	at Altitude 4000 m	-60...+30°C
5	Time to idle after pressing the start button (no more)	60 s
6	Fuel	T-1,TS-1 (in Russian)
7	Oil	B-3V (in Russian)

### TV3-117VM general performance parameters

Engine Specifications in different Power Setting (for ISA) see Table 4.2

**Table 4.2**

Power Setting	SHAFT HORSEPOWER		RPM %			PTIT - °C	
			N1 - All are ± 0.5%		Nr	W/O PSS	W/ PSS
	W/O PSS	W/ PSS	W/O PSS	W/ PSS			
MAX RATED	2200	2100	97.7	97.7	92 - 94%	920	915
TAKEOFF	2000	1900	96.6	96.6	92 - 94%	890	885
MAX LTD CRUISE	1700	1700	95.0	95.5	93 - 97%	845	855
LTD CRUISE	1500	1500	93.9	94.4	93 - 97%	815	825
CRUISE	1200	1200	92.0	92.5	93 -97%	770	780
IDLE	200	200			45 -70%	780	780

NOTE. 1. Values are shown with and without Particle Separators System (PSS) installed

2. PTIT – Power Turbine Inlet Temperature

3. N1 – Turbine RPM

4. Nr – Main Rotor RPM

5. When one engine has failed, the operating engine automatically elevates power to MAX Rated available. MAX Rated Power operating mode can not be active for both engines simultaneously.

Other translate: MAX Rated Power operating mode one of two engine can be activated only when the other engine failure (ie any action of the crew with (for) two simultaneously operating engines can not be set MAX Rated Power).

TV3-117VM – Idle Speed and Maximum Starting Temperature (Fig. 4.3)



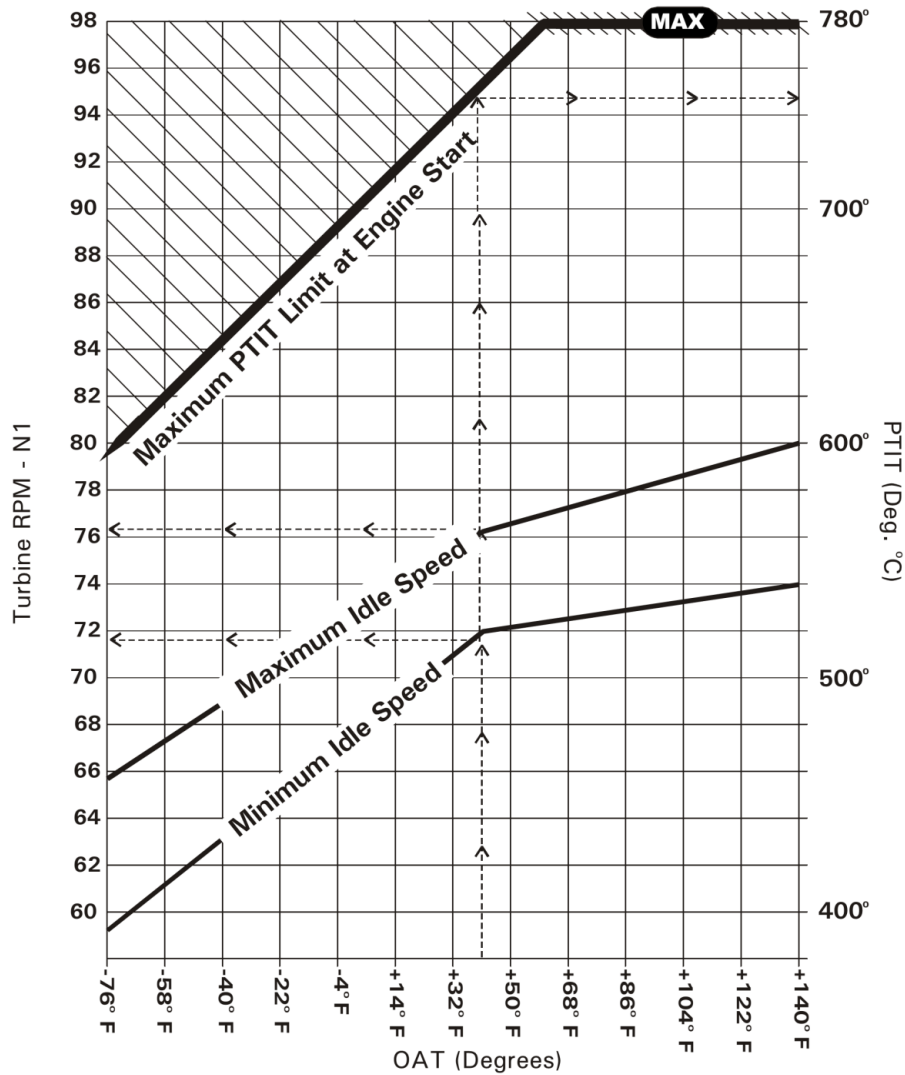

Example:



Enter the graph from the bottom,  
using the reported ambient temperature.  
Ambient Temperature: +41° F  
N1 Minimum = 72%  
N1 Maximum = 76%  
PTIT Maximum = 745° C



**Fig. 4.3. Maximum Idle N1/Starting Temperature**

The **Systems of engine** consists of:

- Air Inlet Particle Separator
- Engine Anti-Ice System
- Engine Fuel System
- Engine Oil System
- Ignition-starting system
- Engine Trim Control

The engines have an integrated regulating system which provides main rotor speed control and synchronizes the power output of both engines. They have both automatic and manual throttle control systems. Either engine may be operated independently to allow for flight or emergency takeoff with one engine inoperative.

#### 4.1.1. Air Inlet Particle Separator System ("PZU")

The "PZU" air inlet Particle Separator System (PSS), or Dust Protection Device (DPD), protects the engine inlet during taxi, takeoff, and landing at unprepared airstrips and in sandy/dusty environments. In addition, the system provides electrical and bleed air anti-ice heating.

The system mounts on the front of the engine, in place of the nose cone assembly. Each engine has an independent particle separator system. The system begins to operate when bleed air is supplied to the ejector by opening the flow control valve.

When the system is running, suction pulls contaminated air into the inlet duct passages (1). Centrifugal forces throw the dust particles toward the aft dome surface (2) where they are driven by the air flow through the separator baffles (4). The main portion of the air, with the dust removed, passes through the duct to the engine air inlet (3). The contaminated air (dust concentrate) is pulled into the dust ejector duct (5) and discharged overboard (6).

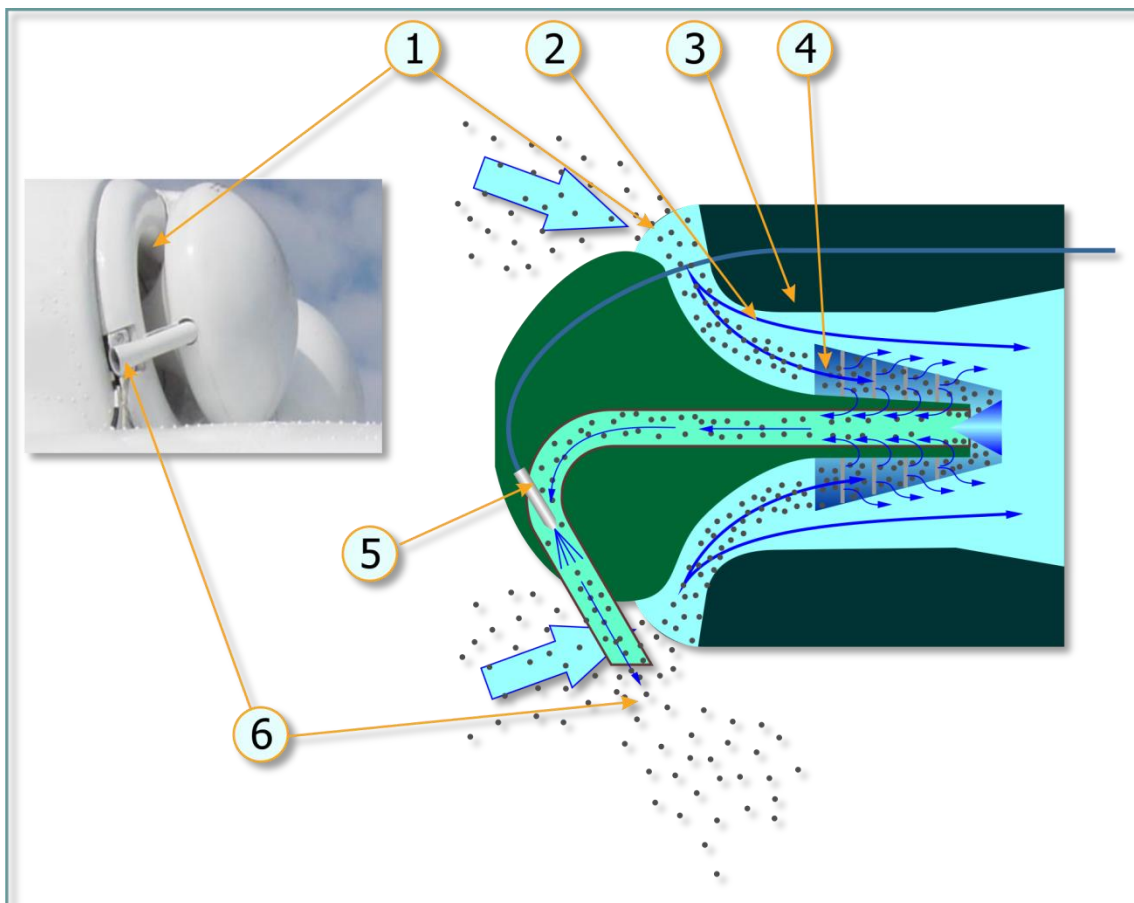

**Fig. 4.4. Air inlet particle separator system functional diagram**

The PZU anti-icing system utilizes a combination of heated air and electrical heating to provide deicing to various helicopter components. The heated air elements of the PZU deicing system are turned on simultaneously with the engine deicing system.

### 4.1.2. Engine Anti-Ice System

See [7.4.3](#)

### 4.1.3. Engine Fuel System

The engine fuel system supplies and controls the fuel flow to the combustion chamber, controls the inlet and compressor variable guide vanes and air discharge valves, and shuts down the engine in the event of power turbine overspeed. The fuel components mounted on the engine include the fuel control, fuel nozzle/manifold assembly, fuel boost pump, fuel/drain valve, filters, and an emergency fuel shutoff valve. The aircraft fuel system supplies fuel to the input of the fuel boost pump. The fuel boost pump increases the fuel pressure to the required level and feeds it to the main fuel filter. The main fuel filter supplies filtered fuel to the inlet of the fuel control. The fuel control's high pressure pump increases the pressure of the fuel. The fuel control meters the fuel and sends the fuel in two flows through the fuel/drain valve unit into the start and main fuel rings of the fuel nozzle/manifold assembly. Fuel seepage from the accessory seals passes through the drainage system lines to the ejector which discharges it into the exhaust pipe. Fuel drainage from the combustion chamber and the air intake valve reaches the fuel/drain valve unit which sends it to the drainage tank on the left side of the fuselage.

#### ***Starting Fuel Flow***

To start the engine fuel supply, the fuel boost pumps must be operating, the engine fire valves and service cell shutoff valve open, the twist grip throttle control rotated full left, and the engine fuel shutoff lever (FSL) set to the OPEN (full forward) position. During engine start, fuel is supplied to the start fuel nozzles. Air is supplied to the main fuel nozzles during engine start to improve atomization of the start fuel. When N1 reaches sufficient speed, fuel begins to flow through the main fuel nozzles.

#### ***Steady State Operation***

The N1 regulator, droop compensator, engine governor, and temperature limiter automatically control the fuel flow into the combustion chamber during steady state operations. Each element affects the fuel flow only during specific conditions. The N1 RPM regulator controls the fuel flow at idle power. The droop compensator adjusts the fuel flow at operational power conditions from flight idle up to limited takeoff. This includes flat pitch descents. The engine governor system and the gas temperature limiter control maximum fuel flow at limited takeoff and takeoff power.

#### ***Temperature Limiter System Operation***

When power turbine inlet gas temperatures reach  $985\pm 5^{\circ}\text{C}$  ( $1796\text{--}1814^{\circ}\text{F}$ ), the temperature limiter begins to send signals to the temp limiter actuator (IM-47). The RT LEFT (or RIGHT) ON caution light on the pilot's left side console begins to flash. As the PTIT continues to increase, the signal pulse duration and the flashing speed of the caution light also increases. This results in increased fuel spillage from the throttle control chamber through the temp limiter actuator, decreasing the amount of fuel fed to the combustion chamber. The gas temperature limits at all power settings

are between 980 and 990°C (1796 and 1814°F). The fuel control includes a slide valve that blocks the actuator if the temperature limiter fails. If the temperature limiter sends a constant false signal or a very high temperature signal to the actuator, the slide valve disengages the actuator when the N1 RPM decreases to  $85\pm 1\%$ .

### ***Compressor Control System Operation***

The variable inlet guide vanes (VIGV), variable guide vanes (VGV), and two air discharge valves maintain the basic engine performance parameters and stability margin. The guide vane controller in the fuel control operates the compressor control system as a function of derived (corrected) N1 RPM. During engine start, when the N1 RPM is below 81%, the VIGV and VGV are set against the upper stop (closed) at an angle of 27 to 28.5°. When the N1 RPM reaches 81%, the guide vanes start to open at a linear rate. When the N1 RPM reaches 100%, the guide vanes are set to an angle of 0°. When N1 exceeds 102%, the guide vanes are fully open against the lower stop at an angle of  $-3\pm 0.5^\circ$ . Reversal of the guide vane setting occurs in a similar manner as the N1 RPM decreases until the vanes close at an N1 RPM of 81%. The air discharge controller operates the air discharge valves at the seventh compressor stage. During engine start and low RPM operation, fuel pressure holds the valves open. When the N1 RPM is between 84 to 87%, (VGV setting of 22°), the air discharge controller diverts fuel to the drain line and the valves close. The valves open during engine deceleration in the same manner.

NOTE. On TV3-117VM engines, the variable guide vanes are set to an angle of  $-6.5^\circ$  when fully open.

### ***Engine Governor Operation***

*A. N1 LOOP.* The engine governor N1 loop prevents compressor overspeed by reducing the fuel flow to the combustion chamber when the preset maximum RPM is reached. The system uses inputs from the N1 RPM transducer mounted on the engine accessory drive, pressure readings from a pressure transducer mounted in the cargo cabin, and temperature readings from the engine inlet temperature probe to monitor and correct the maximum N1 limit. The temperature limiter actuator (IM-3A) controls the amount of fuel reduction.

*B. N2 LOOP.* The N2 loop activates and automatically shuts down the engine in the event of power turbine overspeed ( $118\pm 2\%$ ). The N2 loop uses the input from a pair of N2 transducers mounted in the aft support housing to determine actual N2 speed. The emergency fuel shutoff valve cuts off the fuel flow into the combustion chamber and the engine shuts down if the maximum N2 speed is reached.

NOTE. TV3-117VM engines use an ERD-3VM engine governor system. On Mi-8MTV2 helicopters with TV3-117VM engines, a power boost circuit is included in the governor system to allow maximum power for emergency takeoff with one engine.

### **Engine Shutdown**

Moving the fuel shutoff lever in the cockpit to the STOP (full aft) position controls

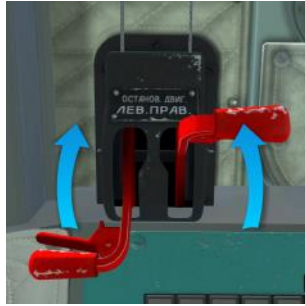

engine shutdown. When this occurs, the stop valve in the fuel control closes, diverting the fuel to the drain line. Fuel flow into the combustion chamber terminates

### **Fuel Supply Switches**

Fuel supply system switches and indicators are located on the center overhead console (see [Fig. 7.7](#)). The panel includes switches for the fuel valves and transfer pumps. Fuel supply system operation is described in [Fuel System](#).

### **Power Controls**

Joint engine operation is controlled using the twist grip throttle control on the pilot or copilot collective sticks. The engines are controlled individually by the pilot's engine condition levers (ECLs). If one engine fails when the engines are operating at power settings above flight idle, as long as the collective pitch remains unchanged, the droop compensator will engage and automatically bring the operating engine to MAX RATED (or Emergency) Power Setting to maintain the main rotor RPM. If the automatic control systems fail, the engine power setting can be controlled by manual adjustment of the twist grip throttle, the collective pitch, and the engine condition levers to maintain the main rotor RPM.

*A. TWIST GRIP THROTTLE/COLLECTIVE CONTROL.* With the throttle turned to the full left position and the collective stick in the full down position, the engines operate at



ground idle. An idle stop is incorporated in the throttle linkage to prevent inadvertent throttle closure. Rotating the throttle control to the full open (clockwise) position allows the engine fuel control systems to maintain constant main





rotor RPM. With full right throttle and the collective full down, the engines operate at flight idle. Higher power settings are controlled by increasing the collective pitch. At main rotor pitch of 12° and higher, the engines operate at limited takeoff power, with maximum fuel flow controlled by the engine governor and gas temperature limiter.

*B. ENGINE CONDITION LEVERS (ECL).* The ECLs ("РРУД" (RRUD) in RU)



vary the N1 control lever (throttle) settings from minimum to maximum power separately for each engine. They are used to control the engine power setting during ground testing and in special flight conditions such as failure ERD-3VM engine governor system, training purposes to practice landing with one engine shut off (for cool the engine, which will be shut down, not necessary in game). The normal position of the ECLs is in the center detents. The engines can be brought to takeoff power by moving the engine condition levers to the maximum settings

*C. EMERGENCY POWER OVERRIDE.* In helicopters equipped with TV3-117VM engines, a power limiter override circuit is included in the engine governor system. The circuit resets the maximum N1 setting of the governor system to allow the engine to gain maximum power (+0.8-1% N1: limiter increases the upper bound limit by 0.8-1%), the resulting maximum power of operation engine will be increased by 200 hp (+200 hp to TAKE OFF Power Setting). The pilot can activate the emergency power circuit by setting the EMERG POWER LH (RH) switches on the engine governor



control panel to the ON (up) positions

When activated **and** one of two engine is failure, the EMERG PWR LH (or RH) ENG caution light on the pilot's master caution panel illuminates.

### ***Engine Power Synchronizers***

The engine fuel controls are linked by power synchronizers to balance joint engine operation. The power synchronizers measure and compare the compressor delivery pressure of both engines. The engine with the lower delivery pressure (the driven engine) receives an increase in fuel flow which increases the N1 RPM. This action also causes an increase in the N1 RPM of the engine with the higher compressor delivery pressure (the driving engine). The droop compensator of the driving engine then reduces the fuel flow and thus, the RPM of the driving engine. The power synchronizers and droop compensators of both engines counterbalance each other until the compressor delivery pressure of both engines is equal. The power synchronizer only affects the fuel flow of the driven engine, while the droop compensator affects the driving engine. If the main rotor RPM surges above 107%, the synchronizer cutoff valve in the engine fuel control disconnects the power synchronizer of the driven engine. The driven engine drops to flight idle, while the driving engine continues to operate at maximum power. To adjust and maintain the correct M/R RPM if the power synchronizer disengages, the pilot must manually adjust the collective pitch, twist grip throttle control, or ECL.

#### **4.1.4. Engine Oil System**

The engine oil system provides lubrication, cooling, and ventilation of the engine support bearings, drives, gears, and other moving parts of the engine. Each engine has an independent, self-contained oil system.

##### ***Description***

The engine oil system is entirely automatic in its operation. The system includes an oil tank with deaeration provisions and sight gage, breather and vent lines, oil cooler with an inlet chip detector, pressure sensor, pressure-activated relief and cutoff valves, filters, and lines. Drain valves are provided for draining the oil tank and cooler. Pressure for engine lubrication and scavenging of return oil is provided by an integrated oil delivery and scavenge pump unit with pressure regulating and shutoff valves, and by a separate pump which scavenges oil from the engine accessory drive. Engine oil cooling is accomplished by an oil cooler with a thermally-activated bypass valve. Hot oil is supplied to the oil cooler from the scavenge section of the oil pump unit. Cooled oil is returned to the oil tank. If the temperature of the oil scavenged from the engine is below 50°C (122°F), the thermal bypass valve opens and the oil is diverted directly to the return line. Air circulation for oil cooling is supplied by a turbine fan that is driven by the main transmission. The fan is powered at all times when the engine is operating; no additional control is required.

Engine Oil System operating range see in [Table 8.8](#)

#### 4.1.5. Ignition-starting system

Starting the APU and main engines procedure see [9.3](#).

The TV3-117VM engines are started by the SV-78B starter turbine, supplied with compressed air by the APU, which begins to turn the engine compressor rotor. The starter turbine also provides for engine cranking and false start.

The ignition-starting system includes the following components:

- SV-78B starter turbine;
- SK-22-2 ignition exciter;
- SP-26P3 igniters (two);
- APD-78A start control box (one for both engines);
- protection, multiplexing, control, and signal generating equipment.

The starter turbine, ignition exciter, and igniters are installed on the engines. The start control box, protection, multiplexing, control and signal generating equipment are installed separately in the helicopter.

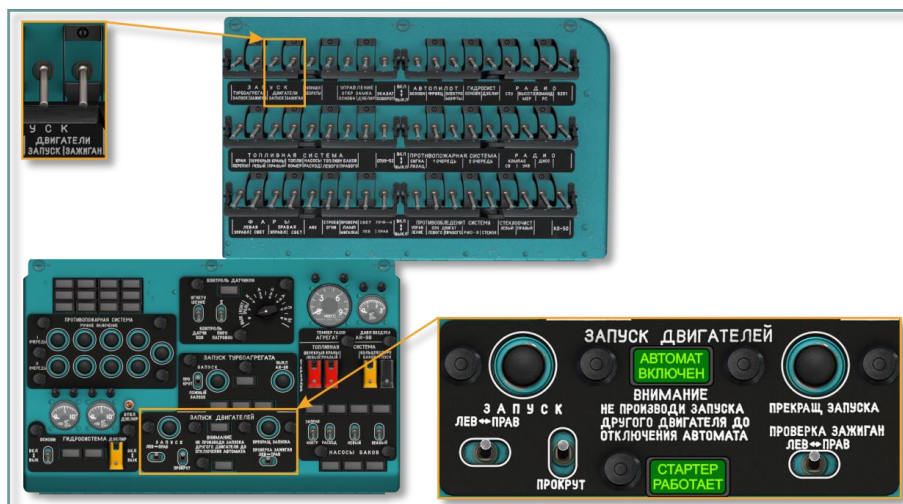

**Fig. 4.5. Engine start control panel**

When starting the TV3-117VM engines, turn on the START ENGINES - "START" and "IGNIT" (ЗАПУСК – ДВИГАТЕЛИ – "ЗАЖИГАН." and "ЗАПУСК") circuit breakers. Set the MODE ("ЗАПУСК –ПРОКРУТ.") selector on the engine start control panel to the START (up) position and set the ENGINE (ЗАПУСК – "ЛЕВ. – ПРАВ.") selector to correspond to the engine being started (LH or RH).

To perform an engine crank or false start, set the MODE ("ЗАПУСК –ПРОКРУТ.") selector to the CRANK (down) position. A false start is performed with the fuel fire (shutoff) valve open, fuel shutoff lever full forward (open), and fuel service cell boost pump engaged. A crank is performed as a false start, except the fuel shutoff lever is held in the aft position (closed).

The start control program is engaged by pressing the START ("ЗАПУСК") pushbutton and can be aborted manually at any time by pressing the ABORT START ("ПРЕКРАЩ. ЗАПУСКА") pushbutton on the engine start control panel.

The AUTO IGNITION ON ("АВТОМАТ ВКЛЮЧЕН") light illuminates to advise that the start cycle is in progress. It is controlled by the engine start control box. The STARTER ON ("СТАРТЕР РАБОТАЕТ") light illuminates when sufficient air pressure is delivered to the engine starter.

If the engine has not attained an N1 (compressor) RPM of 55% within 55 seconds, the starting cycle is automatically aborted.

#### 4.1.6. Engine Trim Control

The engine control system includes a manual adjustment for N2 RPM. The pilot introduces trim changes with the INCR-DECR switch on the collective stick



. The switch is a three-position type and is held in the INCR (up) position to increase the power turbine speed or down to the DECR position to decrease the power turbine speed. The trim adjustment range is from  $91 \pm 2\%$  to  $97^{+2}_{-1}\%$ . The engine condition levers and manual trim control are used to control the engines during engine testing and during special flight conditions (such as failure of one engine) to adjust the M/R RPM to 95%.

#### 4.2. Auxiliary power unit

The AI-9V auxiliary power unit (APU) supplies compressed air to crank the TV3-117VM main engine compressor rotors during engine start. It can also be used to supply 27 VDC power to the onboard electrical systems on the ground and in flight if the generators fail. The APU has its own fuel control, oil system, regulating system, starter-generator unit, and ignition unit. It consists of a centrifugal-type compressor, single stage axial turbine, ring-shaped combustion chamber, exhaust nozzle, drive housing, and integrated oil tank. The APU is mounted in the aft nacelle compartment. It is separated from the transmission compartment by a lateral firewall.



**Fig. 4.6. AI-9V APU mounted on the helicopter**

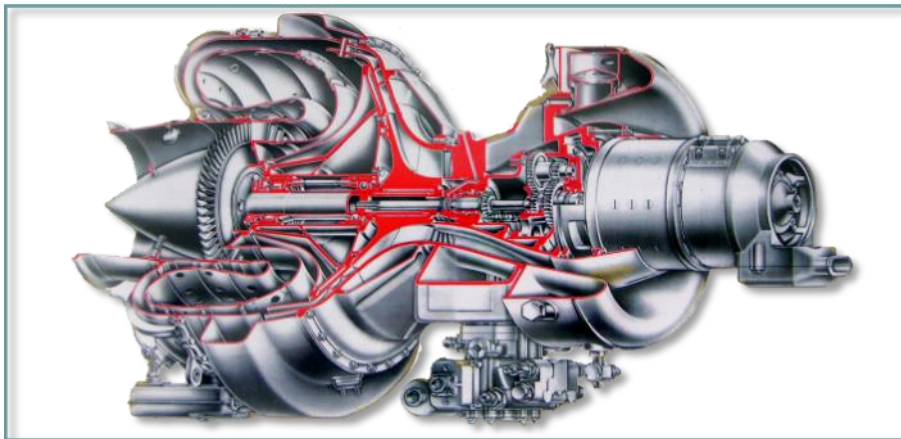

**Fig. 4.7. AI-9V cutout**

The start sequence is automated and controlled by the APD-9V start control box (located in the radio compartment), which produces control signals to engage and disengage components of the system according to the programmed sequence.

The APU start control box controls:

- APU ground start;
- APU false start;
- APU crank cycle;
- APU shutdown at any time during the start, false start or crank cycle.

The AI-9V starting circuits are protected by the START APU - "START" and "IGNIT" (ЗАПУСК ТУРБОАГРЕГАТ "ЗАПУСК" и "ЗАЖИГАН.") circuit breakers on the right circuit breaker console.



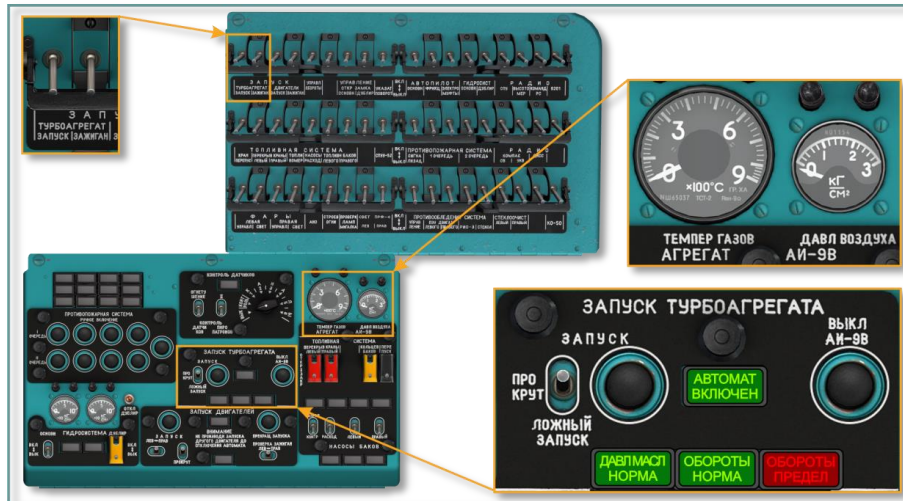

**Fig. 4.8. APU start control panel and circuit breakers**

The starting system is operated by the START-CRANK-FALSE START ("ЗАПУСК-ПРОКРУТ-ЛОЖНЫЙ ЗАПУСК") switch, the START ("ЗАПУСК") and APU OFF ("ВЫКЛ. АИ-9В") pushbuttons on the APU start control panel.

APU exhaust gas temperature is displayed by the APU EGT ("ТЕМПЕР. ГАЗОВ") gauge. The pressure in the APU main bleed air channel is displayed by the APU air pressure ("ДАВЛ. ВОЗДУХА") gauge.

The lamp indicators on the APU start control panel include the APU OIL PRESSURE NORMAL ("ДАВЛ. МАСЛА НОРМА") light, APU RPM NORMAL ("ОБОРОТЫ НОРМА") light, and APU OVERSPEED ("ОБОРОТЫ ПРЕДЕЛ") light.

When the starting sequence is engaged, the APU AUTOSTART ("АВТОМАТ. ВКЛЮЧЕН") light illuminates.

### 4.3. Drive system

The VR-14 main transmission is mounted on top of the center fuselage deck. The mounting struts attach at four points to the fuselage. The transmission is essentially a reduction gearbox designed to transmit the sum power of both TV3-117VM engines to the main rotor, tail rotor, oil cooler fan, and accessories (two hydraulic pumps, two AC generators, two rotor tachometers, and an air compressor) at a reduced and adjustable RPM. The drive system includes:

- intermediate gearbox;
- tail rotor gearbox;
- transmission driveshafts;
- rotor brake system.

The main transmission includes freewheeling clutches in the input quills to provide a quick-disconnect of one or both engines in case of a power failure. This allows for safe flight with one engine inoperative and allows main and tail rotors to rotate in order to accomplish a safe autorotation landing.

Magnetic chip detectors and warning lamps are provided to control accumulation of metal shavings in the transmission oil system. An oil temperature probe and an oil pressure sensor are incorporated.

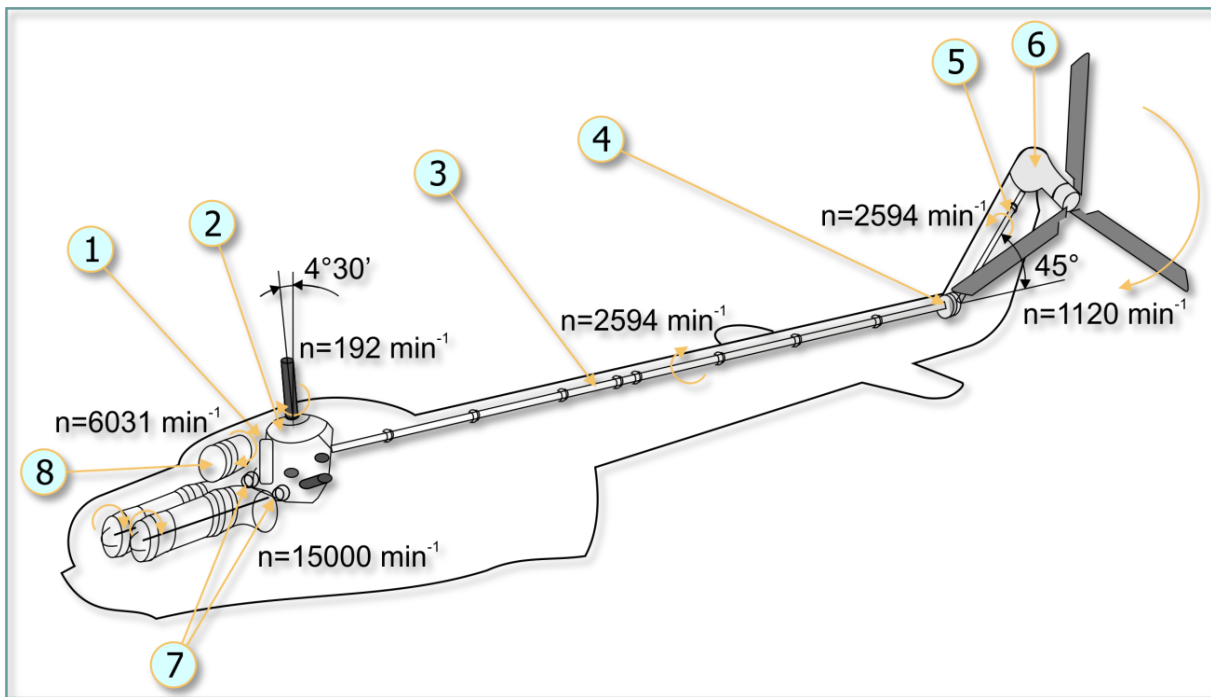

**Fig. 4.9. Helicopter drive system**

- |                             |  |
|-----------------------------|--|
| 1. Oil cooler driveshaft;   | 5. Rear tail rotor driveshaft section; |
| 2. VR-14 main transmission; | 6. Tail rotor gearbox;                 |
| 3. Tail rotor driveshaft;   | 7. TV3-117VM engine driveshafts;       |
| 4. Intermediate gearbox;    | 8. Oil cooler fan.                     |

The **intermediate gearbox** is designed to change the angle of the tail rotor driveshaft axis by  $45^\circ$  to conform with the angle between the tail boom and vertical stabilizer.

The **tail rotor gearbox** is designed to rotate the tail rotor at the required RPM. The last linked section of the tail rotor driveshaft is coupled to the tail rotor gearbox input flange. The tail rotor hub mounts on the tail rotor gearbox output flange. Tail rotor pitch is changed by the control rod, located inside the output shaft.

The **transmission driveshafts** include the tail rotor driveshaft and oil cooler fan driveshaft.

The tail rotor driveshaft is designed to pass the torque from the main transmission via the intermediate gearbox and the tail rotor gearbox to the tail rotor. The main transmission and intermediate gearbox are connected by the horizontal section of the tail rotor driveshaft. The intermediate gearbox and tail rotor gearbox are connected by the angled rear section of the tail rotor driveshaft housed inside the vertical stabilizer.

The oil cooler fan driveshaft transmits power from the transmission to the oil cooler fan. The driveshaft is bolted to the transmission offset quill at the front of the transmission. It connects to the oil cooler fan via a splined coupling.

The **rotor brake** reduces the time required to stop the main rotor. It is also used to block the transmission while the helicopter is parked and during maintenance operations.

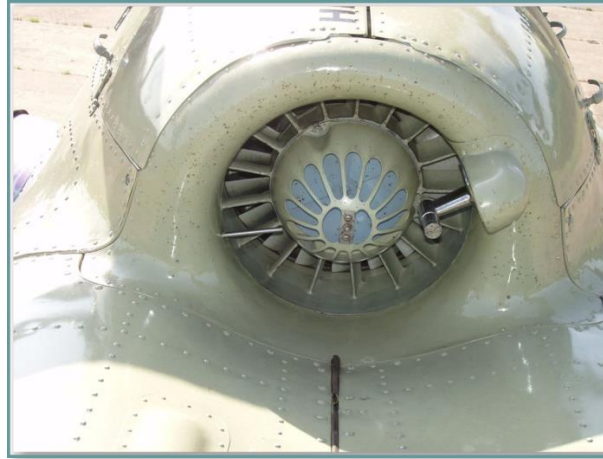

**Fig. 4.10. Rotor brake control lever**

The rotor brake consists of a drum and shoes assembly mounted on the main transmission tail rotor output quill. The brake is operated by a cable linkage from the rotor brake control lever located to the right of the pilot's seat.

#### ***4.4. Air cooling system***

The air cooling system includes the oil cooler fan assembly, distribution lines, and cooling shrouds. The oil cooler fan cools the oil in the engine and transmission oil coolers, the AC generators, the hydraulic pumps, and the air compressor. The oil cooler fan assembly mounts over the rear section of the engine compartment as part of a common nacelle. The oil cooler fan collects air via a dedicated oil cooler fan inlet.



**Fig. 4.11. Oil cooler fan**

The fan cools the oil in the engine and transmission by blowing air directly through the oil coolers. Hot air vents from the transmission compartment via an exhaust shroud at the rear of the oil coolers. The remainder of the air passes through protective shrouds to flexible lines to cool the generators, hydraulic pumps, and the air compressor.





**5**

***COCKPIT SYSTEMS AND CONTROLS***



## 5. COCKPIT SYSTEMS AND CONTROLS

The cockpit includes control panels with various systems and equipment (Cockpit layout), flight controls, Powerplant and Helicopter systems controls and indicators, Flight data and Navigation Systems controls and indicators.

The helicopter's cockpit systems and controls suite provides for:

- a) flight control and navigation in day and night time conditions in visual or instrument meteorological conditions;
- b) control of engine, transmission, and flight performance.
- c) control of all helicopter systems.

*DCS provides pop-up "hints" to identify all of the interactive cockpit controls/switches to ease familiarization with helicopter systems. To see the hint for a particular control/switch, simply hover the mouse over it in the cockpit. Pop-up hints can be enabled/disabled in the OPTIONS menu.*

*In the simulation, the mouse can be used to perform the following actions:*

- left-click to engage a switch/button;
- right-click or left-click to manipulate a multi-position switch;
- rotate the mouse wheel or left-click, hold and drag the mouse to turn a rotary switch/dial.

*When the mouse cursor is placed over an interactive cockpit control, the yellow cross icon changes color to green to indicate the control is clickable and changes shape to indicate whether the control is discrete or rotary type. All of the mouse clickable controls are provided a keyboard shortcut, which can be found in the INPUT OPTIONS menu. Keyboard shortcuts are also provided in this manual in blue color.*

## 5.1. Cockpit layout



**Fig. 5.1. Cockpit layout**

- |   |  |
|---|--|
| 1. Left side console  | 17. Cockpit fans   |
| 2. Left triangular panel                                      | 18. Left instrument panel                                      |
| 3. Intercommunications set SPU-7 control boxes for pilot      | 19. Right instrument panel                                     |
| 4. Fuel shutoff levers (fuel cut-off triggers) of the engines | 20. ЭСБР-3П/А (ESBR-3P/A) Electrical release control box       |
| 5. Pilot Sight PKV  | 21. Center console   |
| 6. Left overhead console                                      | 22. Copilot Sight ОПБ-1р (OPB-1R) – bombing sight, not modeled |
| 7. Left circuit breaker console                               | 23. Right auxiliary panel                                      |
| 8. Center overhead console                                    | 24. Rotor brake lever  |
| 9. Right circuit breaker console                              | 25. Throttle handles   |
| 10. Right overhead console                                    | 26. Collective control handle                                  |
| 11. Intercommunications set SPU-7 control boxes for copilot   | 27. Anti-torque pedals   |
| 12. Right triangular panel                                    | 28. Pitot tube selector  |
| 13. Right side console  | 29. Cyclic control stick                                       |
| 14. Right rear console  | 30. G-load indicator   |
| 15. Copilot's weapons control panel                           | 31. Magnetic compass КИ-13 (KI-13)                             |
| 16. Outdoor temperature gauge                                 |  |

### 5.1.1. Left Instrument Panel (Pilot)



**Fig. 5.2. Left instrument panel (pilot)**

- |  |  |
|--|--|
| 1. Pilot's landing/search and taxi light controls          | 11. APK CB-УКВ (ADF HF-VHF) switch   |
| 2. УР-117М (UR-117M) engine pressure radio (EPR) indicator | 12. УГР-4УК (UGR-4UK) directional gyro   |
| 3. ИП-21 (IP-21) main rotor pitch angle indicator          | 13. АГБ-3К (AGB-3K) attitude indicator   |
| 4. ИТЭ-2Т (ITE-2T) two-pointer engine tachometer indicator | 14. Hover and low speed control indicator  |
| 5. ИТЭ-1Т (ITE-1T) main rotor tachometer indicator         | 15. ВР-30МК (VR-30MK) vertical velocity indicator  |
| 6. Radar altimeter switch                                  | 16. Manual flare dispersion button at UV-26 countermeasures                                    |
| 7. УС-450К (US-450K) airspeed indicator                    | 17. Annunciators (lights)  |
| 8. УВ-5М (UV-5M) radar altimeter indicator                 | 18. ЭУП-53 (EUP-53) turn indicator   |
| 9. ВД-10ВК (VD-10VK) pressure altimeter indicator          | 19. "СЕТЬ ПИТ.ОТ АКК" ("BATTERY IN USE") light (above) and "ОТАКАЗ 6201" ("6201 FAIL") (below) |
| 10. ОПБ-1Р (OPB-1R) bomb sight course indicator            | 20. Annunciators (lights)  |
|  | 21. 2УТ-6К (2UT-6K) exhaust gas temperature indicator  |
|  | 22. Annunciators (lights)  |
|  | 23. Pitot tube selector  |



(17) Warning light:



1. Chips in Main Gearbox
2. Chips in Intermediate Gearbox
3. Chips in Tail Rotor Gearbox

(20) Warning light:

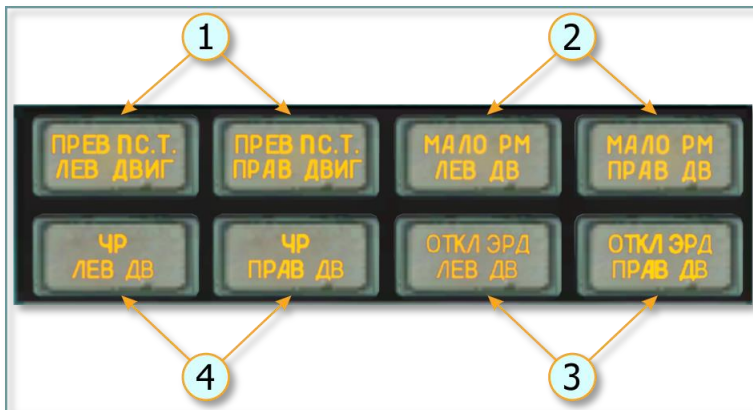

1. Left (right) engine Free Turbin Overspeeding
2. Left (right) engine Oil Pressure is Low
3. Electronic Control left (right) engine OFF
4. Emergency Power (ЧР – Чрезвычайный Режим) left (right) engine

(22) Warning light:

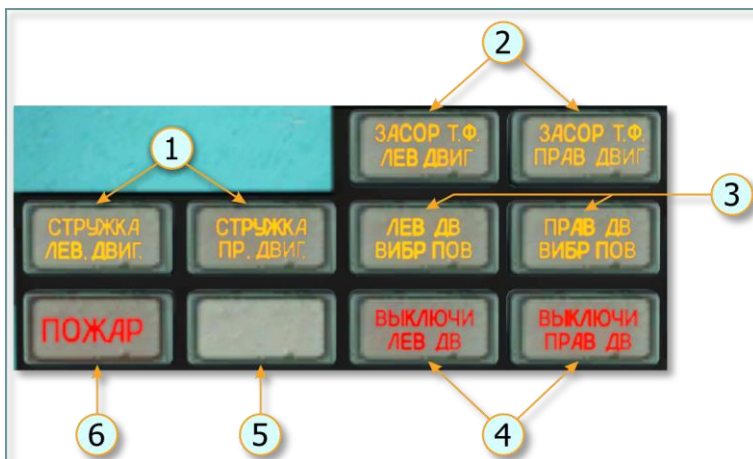

1. Chips in left (right) engine Oil
2. Fuel Filter Clogging left (right) engine
3. Left (right) engine Abnormal vibration
4. Left (right) engine Excursion Limit vibration
5. Light is not used
6. Fire

### 5.1.2. Right Instrument Panel (Copilot)



**Fig. 5.3. Right instrument panel (copilot)**

- |   |   |
|---|---|
| 1. УС-450К (US-450K) airspeed indicator                   | 9. Copilot's landing/search light switch                              |
| 2. ВД-10ВК (VD-10VK) pressure altimeter indicator         | 10. ТВ-1 (TV-1) cabin temperature indicator                           |
| 3. АГБ-3К (AGB-3K) attitude indicator                     | 11. ДИСС-15 (DISS-15) Doppler system coordinate indicator             |
| 4. УГР-4УК (UGR-4UK) directional gyro                     | 12. ДИСС-15 (DISS-15) Doppler system ground speed and drift indicator |
| 5. ВР-30МК (VR-30MK) vertical velocity indicator          | 13. БЭ-09К (BE-09K) fuel quantity indicator                           |
| 6. "ДИСС ОТКАЗАЛ" Doppler system fail annunciator         | 14. Low Fuel (270 L) annunciator                                      |
| 7. ИТЭ-1Т (ITE-1T) main rotor tachometer indicator        | 15. П-8УК (P-8UK) fuel meter switch                                   |
| 8. ИТЭ-2Т (ITE-2T) two-pointer engine tachometer indicato | АЧС-1 (ACHS-1) clo  |



### 5.1.3. Center Console

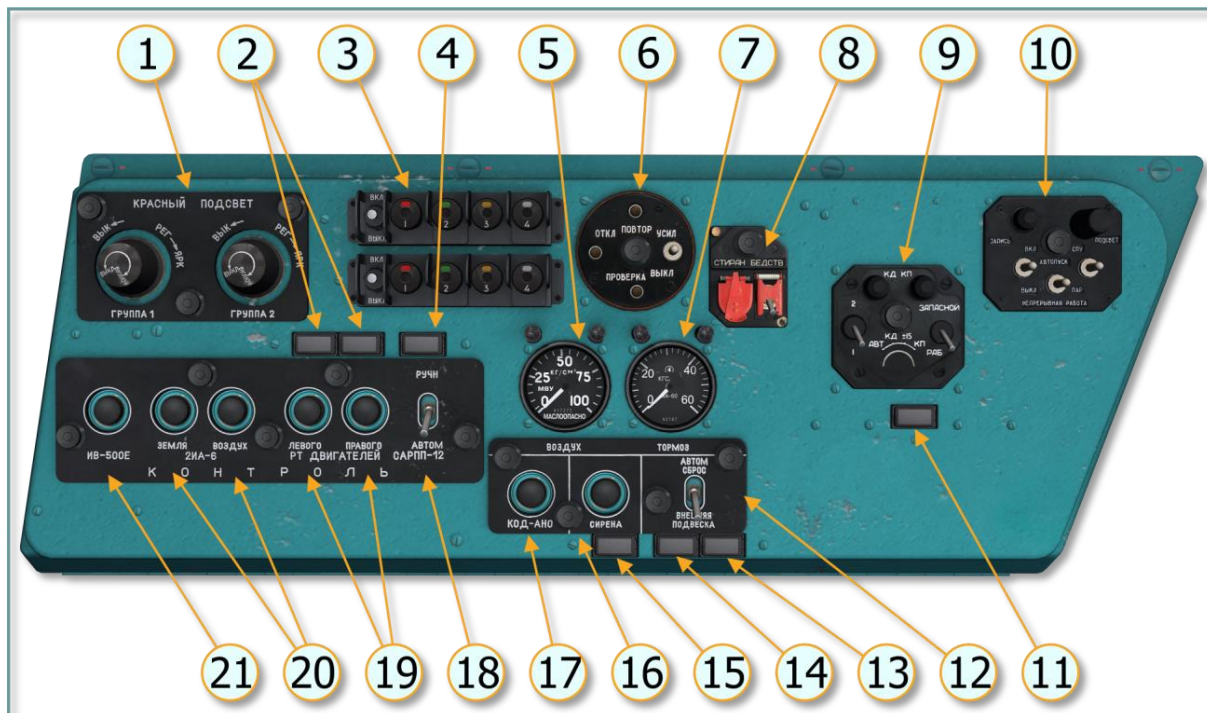

**Fig. 5.4. Center console**

1. УИЗ-6 (UIZ-6) main transmission oil temp, intermediate and tail rotor gearbox oil pressure indicator
2. ТУЭ-48 (TUE-48) main transmission oil temp indicator
3. УИЗ-3 (UIZ-3) left engine oil pressure and temp indicator
4. УИЗ-3 (UIZ-3) right engine oil pressure and temp indicator
5. P-863 (R-863) VHF radio manual/preset selector
6. P-863 (R-863) VHF radio control panel

7. P-863 (R-863) VHF radio frequency select panel
8. Engine governor control panel
9. Lamp test and electrical system backup switches
10. АП-34Б (AP-34B) autopilot control panel
11. БУ-32-1 (BU-32-1) control unit for the СПУУ-52 (SPUU-52) pitch limit system
12. ИН-4 (IN-4) trim indicator of the automatic flight control system

### 5.1.4. Left Side Console



**Fig. 5.5. Left side console**

- |  |   |
|--|---|
| <ol style="list-style-type: none"> <li>1. Left side group 1/2 red lighting dimmers</li> <li>2. "РТ ЛЕВ РАБОТАЕТ" "РТ ПРАВ РАБОТАЕТ" LH/RH engine temp regulator operating annunciators</li> <li>3. ЭП-662 (EP-662) signal flares control panel</li> <li>4. "САРПП РАБОТАЕТ" flight data recorder (FDR) operating annunciator</li> <li>5. МВУ-10К (MVU-10K) pneumatic system air pressure gauge</li> <li>6. РИ-65Б (RI-65B) voice warning system remote control panel</li> <li>7. МА-60К (MA-60K) air pressure gauge for the landing gear wheel brake system</li> <li>8. Control panel 484 of "device 6201" (IFF responder)</li> <li>9. Control panel 485 of "device 6201" (IFF responder)</li> </ol> | <ol style="list-style-type: none"> <li>10. П-503Б (P-503B) cockpit voice recorder (CVR) control panel</li> <li>11. "ВКЛЮЧИ ЗАПАСНОЙ" ("Set Reserve") annunciator</li> <li>12. External cargo auto release switch</li> <li>13. "СТВОРКИ ОТКРЫТЫ" ("Doors open") annunciator</li> <li>14. "ЗАМОК ОТКРЫТ" ("Shackle open") annunciator</li> <li>15. "СИРЕНА ВКЛЮЧЕНА" ("Horn on") annunciator</li> <li>16. Air horn button</li> <li>17. Code NAV lights button</li> <li>18. FDR power switch</li> <li>19. LH/RH engine temp regulator test buttons</li> <li>20. EGT gauge ground and air test buttons</li> <li>21. ИВ-500Е (IV-500E) engine vibration indicator test button</li> </ol> |
|--|---|

### 5.1.5. Left Triangular Panel

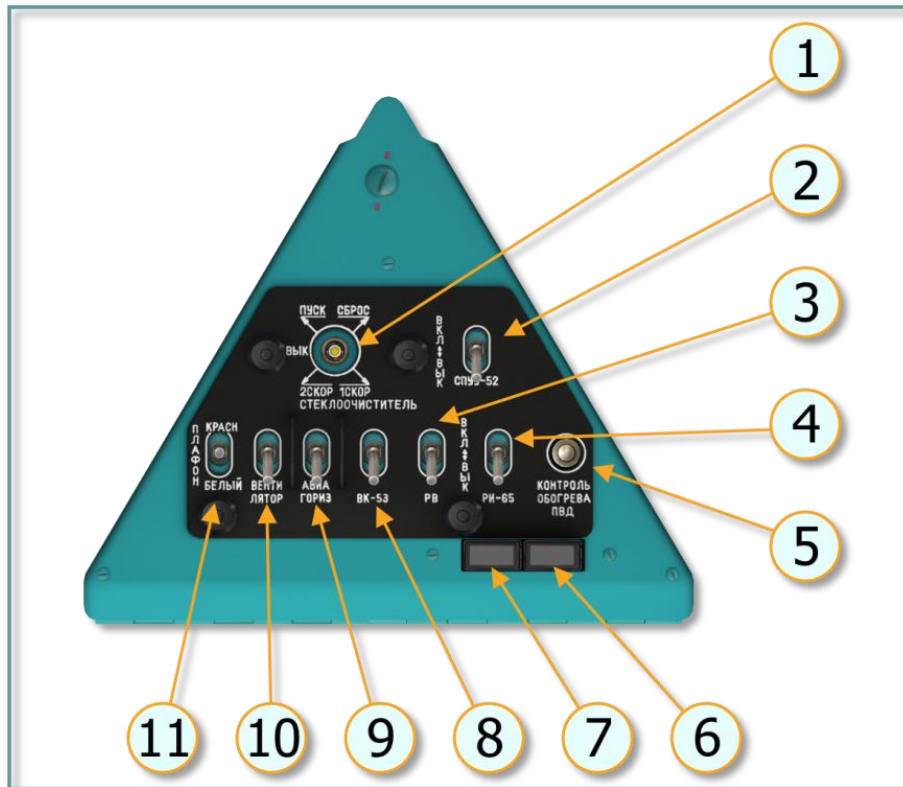

**Fig. 5.6. Left triangular panel**

- |   |  |
|---|--|
| 1. Windshield wiper switch                                      | 7. "ВКЛЮЧИ РИ-65" (Turn on VWS) annunciator          |
| 2. СПУУ-52 (SPUU-52) tail rotor pitch limit system power switch | 8. ВК-53 (VK-53) gyro correction cutout power switch |
| 3. Radar altimeter power switch                                 | 9. Left attitude indicator power switch              |
| 4. РИ-65 (RI-65) voice warning system (VWS) power switch        | 10. Fan power switch                                 |
| 5. Pitot tube heating test switch                               | 11. Dome light switch                                |
| 6. "ОБОГРЕВ ИСПРАВЕН" (Heater OK) annunciator                   |  |

### 5.1.6. Left Overhead Console

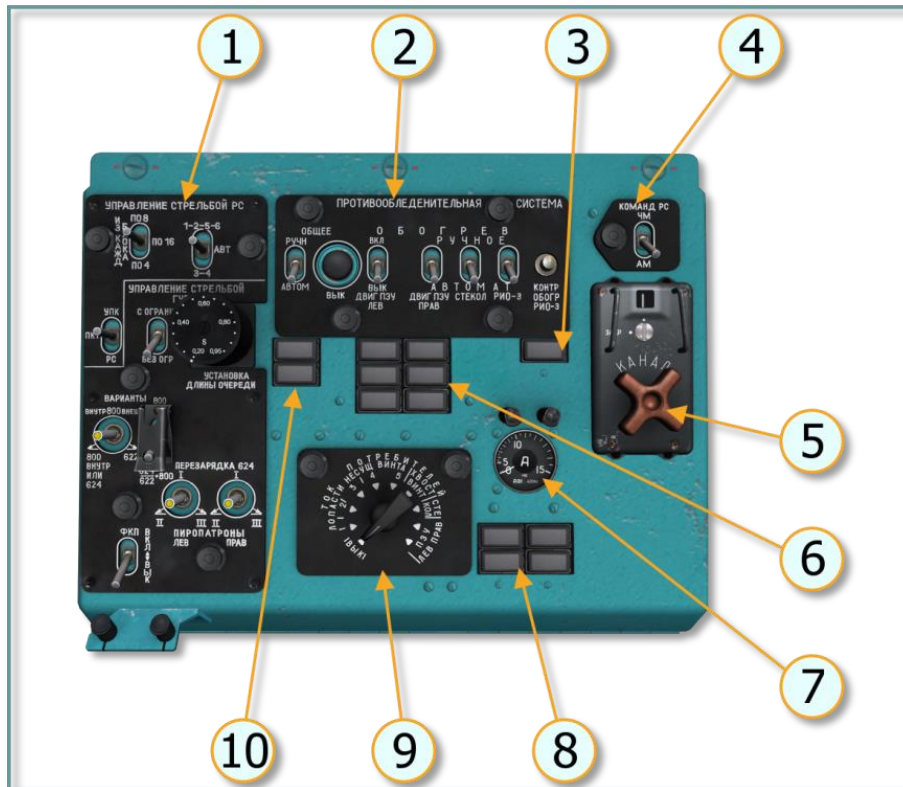
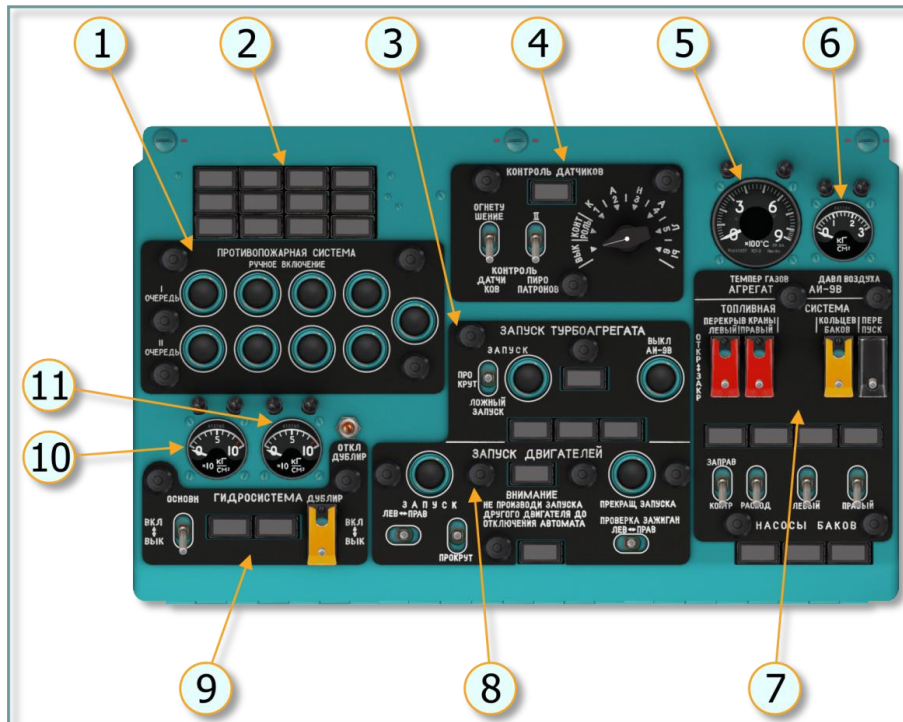

**Fig. 5.7. Left overhead console**

- |   |   |
|---|---|
| 1. Pilot's weapons control panel                    | 6. Anti-ice system annunciator panel                        |
| 2. Anti-ice system control panel                    | 7. АФ1-150 (AF1-150) ammeter                                |
| 3. "ОБОГРЕВ ИСПРАВЕИ" (Anti-ice normal) annunciator | 8. Section 1...4 annunciator panel                          |
| 4. P-863 (R-863) VHF radio FM/AM switch             | 9. Ammeter load current selector switch                     |
| 5. P-863 (R-863) VHF radio channel selector         | "ОБЛЕДЕН" (Icing) "ПОС ВКЛЮЧЕНА" (Anti-ice ON) annunciators |



### 5.1.7. Center Overhead Console



**Fig. 5.8. Center overhead console**

- |  |   |
|--|---|
| 1. Fire protection system panel              | 7. Fuel system control panel                    |
| 2. Fire protection system panel annunciators | 8. Engine start control panel                   |
| 3. APU start control panel                   | 9. Hydraulic system control panel               |
| 4. Fire protection system test panel         | 10. Main hydraulic system pressure indicator    |
| 5. APU EGT indicator                         | 11. Reserve hydraulic system pressure indicator |
| 6. APU air pressure indicator                |   |



### 5.1.8. Right Overhead Console



**Fig. 5.9. Right overhead console**

- |  |   |
|--|---|
| <ul style="list-style-type: none"> <li>1. APK-15 (ARK-15) ADF control panel</li> <li>2. APK-УД (ARK-UD) ADF control panel</li> <li>3. ПУ-26 (PU-26) control panel of the ГМК-1А (GMK-1A) gyrocompass system</li> </ul> | <ul style="list-style-type: none"> <li>4. APK-15 (ARK-15) frequency selector</li> <li>5. КО-50 (KO-50) heater temp regulator switch</li> <li>6. КО-50 (KO-50) heater control panel with annunciators</li> </ul> |
|--|---|

### 5.1.9. Circuit Breaker Consoles

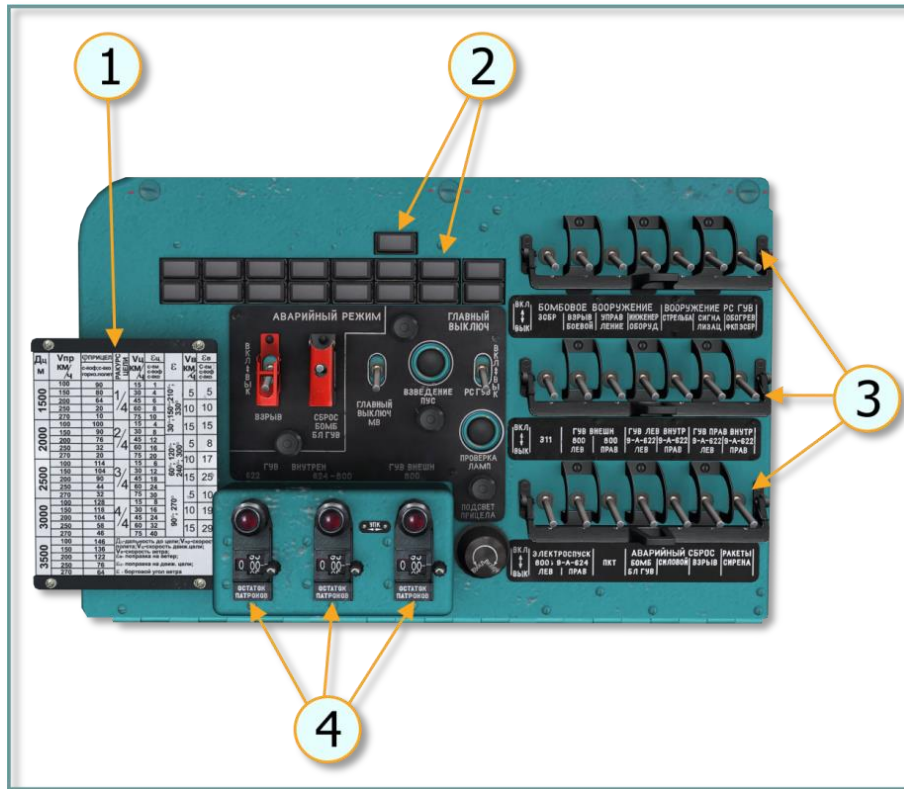

Fig. 5.10. Left circuit breaker console

1. Aiming correction table
2. Weapons arming panel

3. Weapon systems circuit breakers
4. Remaining ammunition indicators

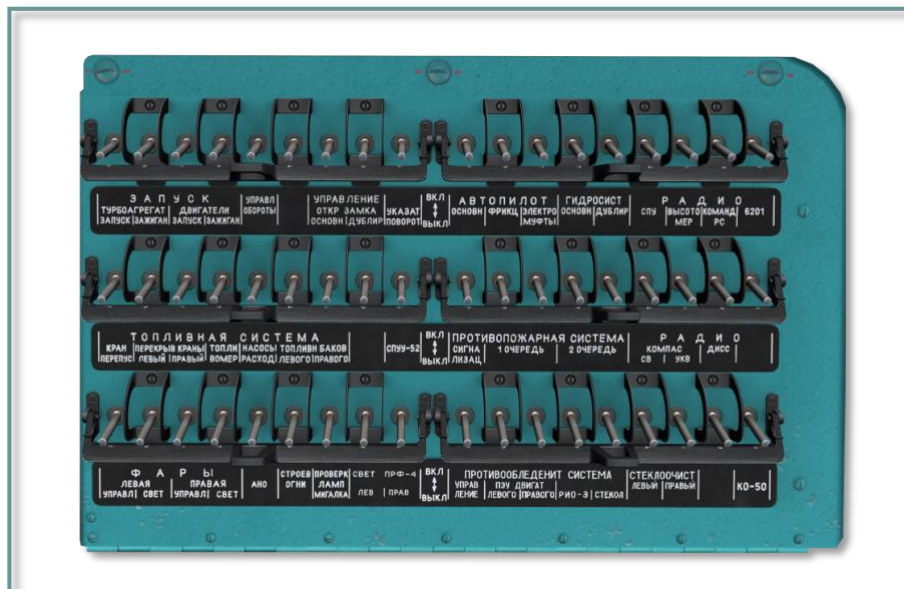
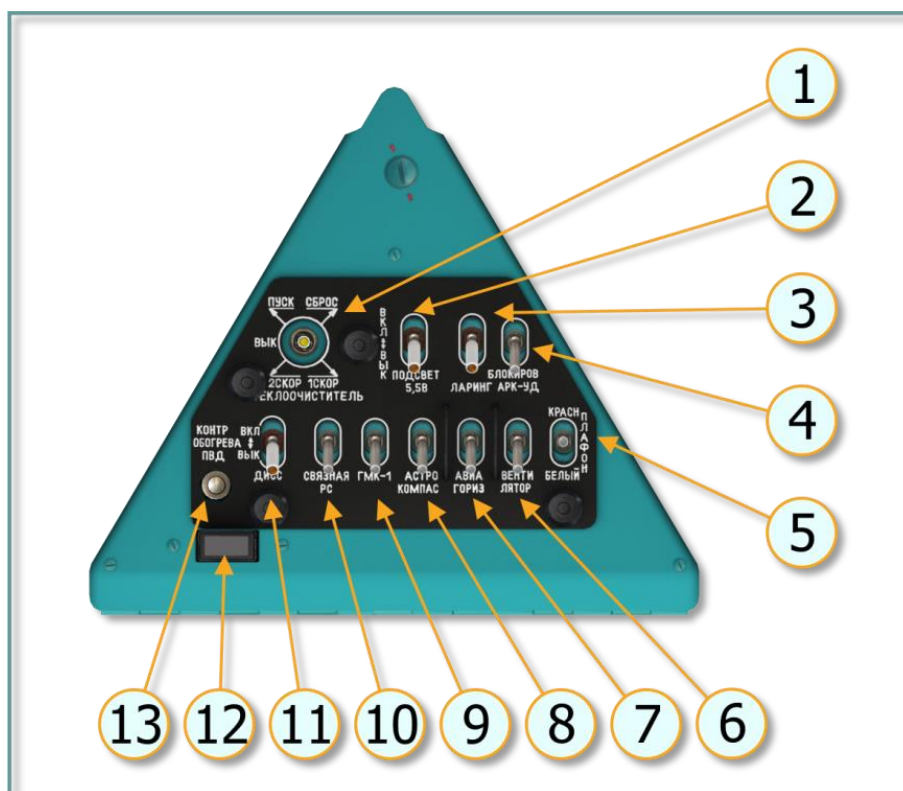

Fig. 5.11. Right circuit breaker console

### 5.1.10. Right Triangular Panel



**Fig. 5.12. Right triangular panel**

- |  |  |
|--|--|
| 1. Windshield wiper switch   | 8. Astrocompass power switch                     |
| 2. ДИСС-15 (DISS-15) Doppler system and ЯДРО-1А (Yadro-1A) radio control panel lighting switch | 9. ГМК-1 (GMK-1) gyrocompass system power switch |
| 3. Microphone power switch   | 10. Yadro-1A HF radio power switch               |
| 4. VHF-ADF interlock switch  | 11. Doppler system power switch                  |
| 5. Dome light switch   | 12. "ОБОГРЕВ ИСПРАВЕИ" (Heater OK) annunciator   |
| 6. Fan power switch  | 13. Pitot tube heating test switch               |
| 7. Right attitude indicator power switch   |  |

### 5.1.11. Right Side Console

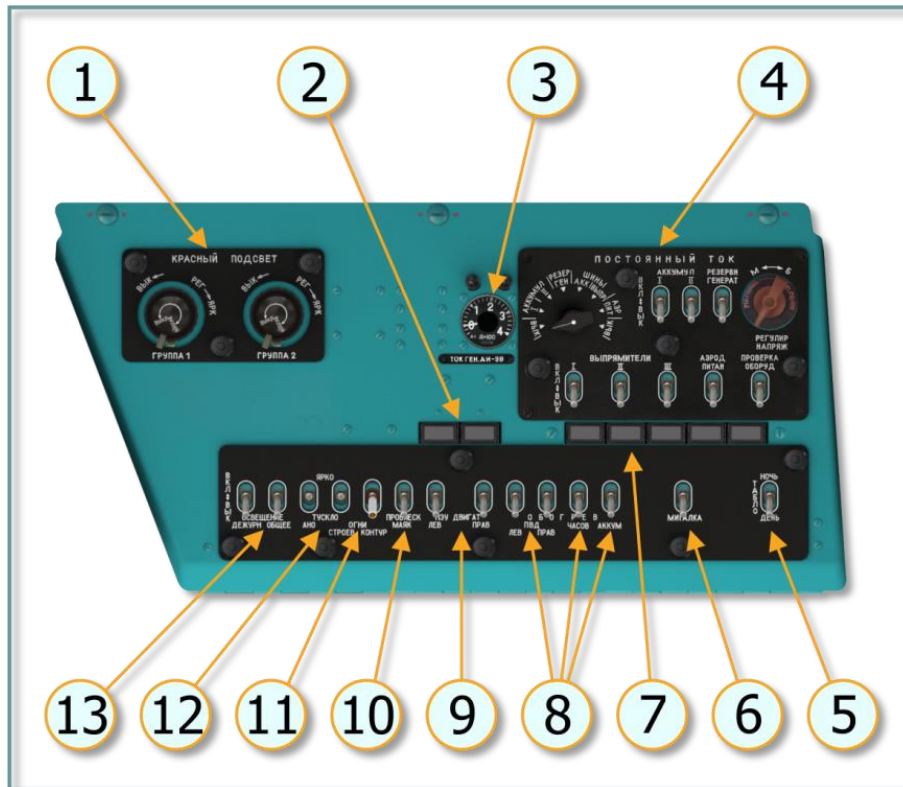

**Fig. 5.13. Right side console**

- |   |   |
|---|---|
| <ol style="list-style-type: none"> <li>1. Right side group 1/2 red lighting dimmers</li> <li>2. "ЛЕВ/ПРАВ ПЗУ ВКЛЮЧЕН"(L/R Dust Protection ON) annunciators</li> <li>3. APU generator load indicator</li> <li>4. DC power control panel</li> <li>5. Annunciators brightness switch</li> <li>6. Warning blinker switch</li> <li>7. Rectifiers, external power, and BIT annunciators</li> </ol> | <ol style="list-style-type: none"> <li>8. LH/RH pitot tube, clock, and battery heating switches</li> <li>9. L/R engine dust protection switches</li> <li>10. Strobe light switch</li> <li>11. Rotor tip and formation light switches</li> <li>12. Navigation and formation lights brightness switches</li> <li>13. General and standby cabin lighting switches</li> </ol> |
|---|---|

### 5.1.12. Right Rear Console



**Fig. 5.14. Right rear console**

- |                             |  |
|-----------------------------|--|
| 1. DC voltmeter             | 11. AC voltage control rotary 1/2                                      |
| 2. DC battery 1 ammeter     | 12. Inverter 1 MAN/AUTO switch   |
| 3. DC battery 2 ammeter     | 13. Inverter 2 MAN/AUTO switch   |
| 4. AC rectifier 1 voltmeter | 14. External power switch  |
| 5. AC rectifier 2 voltmeter | 15. Generator 1, 2 fail; External power, PO-500<br>heater annunciators |
| 6. AC rectifier 3 voltmeter | 16. Generator 2 switch   |
| 7. AC generator voltmeter   | 17. Generator 1 switch   |
| 8. AC generator 1 ammeter   |  |
| 9. AC generator 2 ammeter   |  |
| 10. AC power control panel  |  |



### 5.1.13. Right Auxiliary Panel



**Fig. 5.15. Right auxiliary panel**

- |  |  |
|--|--|
| <ol style="list-style-type: none"> <li>1. P-828 (R-828) radio control panel</li> <li>2. P-828 (R-828) radio power switch</li> <li>3. P-828 (R-828) ANT-ADF switch</li> </ol> | <ol style="list-style-type: none"> <li>4. YB-26 (UV-26) countermeasures control panel</li> <li>5. Yadro-1I HF radio set control panel</li> </ol> |
|--|--|

## ***5.2. Flight controls***

The helicopter is equipped with lateral, longitudinal, integrated collective pitch-throttle, and directional flight control subsystems. Control inputs are transferred from the cockpit to the rotor blades by mechanical linkages and hydraulic servos. Cables are utilized in the rotor brake system and partially for tail rotor pitch control. Pilot control is assisted by an automatic flight control system (AFCS) with an integrated four channel autopilot, the hydraulic flight control servos, and pitch, roll, and yaw trim systems. Both the pilot and copilot have collective, cyclic, and directional controls, which are carried by mechanical linkage to the first and second stage control units which combine, sum, and couple the cyclic, collective, and yaw inputs. Resultant output signals are boosted and routed to the main and tail rotors through mechanical linkages with the hydraulic servos.

Force centering devices are incorporated in the cyclic control system. The devices furnish a force gradient or "feel" to the cyclic sticks. The farther the stick is deflected, the more force is applied. A TRIM DISENGAGE button is located on the pilot and copilot cyclic stick grips. Pressing and holding the TRIM DISENGAGE button will immediately reduce the forces on stick to zero. Releasing the button reengages the trim.

### **5.2.1. Cyclic Control System**

Lateral and longitudinal control of the helicopter is by movement of the cyclic sticks through push rods, bellcranks, and servos to the main rotor swashplate. Movement in any direction tilts the plane of the main rotor blades in the same direction, thereby causing the helicopter to move in that direction.

The pilot's (left) and copilot's (right) cyclic control sticks are nearly identical in design and construction and are installed symmetrically on the cockpit floor relative to the longitudinal axis of the helicopter.

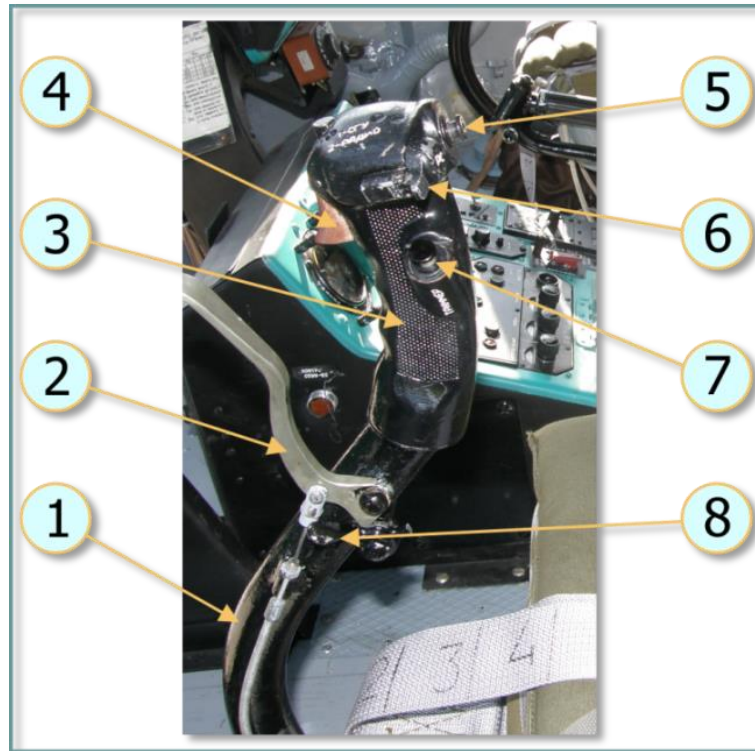

**Fig. 5.16. Pilot's cyclic control stick**

The cyclic control stick is constructed out of a shaped metal tube assembly (1) with a hard rubber hand grip (3), which includes four buttons: ICS/RADIO keying button (trigger position) (4), Autopilot OFF button (5), FIRE button (6), TRIM button (7). The pilot's (left) cyclic also includes a wheel brake control lever (2) and a latch to maintain it in the locked position (8).

**Longitudinal stop:** A hydraulic cylinder and mechanical stop are included in the longitudinal control linkage to limit swashplate aft tilt to a maximum of  $2^{\circ}12'$  when the helicopter is on the ground or taxiing. The stop is controlled by weight-on-wheels microswitches mounted on the main landing gear strut supports. As the pilot pulls back on the cyclic, the longitudinal stop causes a sharp increase in the force required to move the stick when the swashplate aft tilt reaches  $2^{\circ}12'$ . As the helicopter lifts off the ground, the microswitch contacts open and the stop disengages, releasing the limit on aft swashplate tilt.

### 5.2.2. Directional Control System

The directional control system is operated by the pilot or copilot pedal assemblies. From the pedals to the directional servo, the control linkage consists of a system of push/pull rods and bellcranks. Cables are used to pass control inputs to the tail rotor gearbox. The pitch change mechanism for the gearbox consists of a chain, sprocket, and worm gear, which extends or retracts the pitch control rod. Rod movement is transmitted via the pitch change links to the blade grips, resulting in a change of blade angle. Pushing the left pedal forward causes the pitch control rod to retract. The blade pitch angle decreases and the helicopter turns to the left. Pushing the right pedal forward extends the pitch control rod, increasing the blade pitch angle, and the helicopter turns to the right. Right pedal movement is limited by a moveable stop (pitch limiter) system which uses air density and temperature to adjust the

maximum tail rotor pitch angle and prevent overloading the tail rotor and drive system.

The pedals are mounted on a bracket on the cockpit floor in front of the seat. Pedal adjusters are provided to adjust the pedal distance for individual comfort. The adjustment range is  $\pm 2.9$  inches. Microswitches are mounted in each sub-pedal assembly to allow the pilot to introduce directional control inputs while the autopilot yaw channel is engaged.



**Fig. 5.17. Anti-torque pedals**

Force centering devices are incorporated in the directional control system. The devices furnish a force gradient or "feel" to the pedals. The farther the pedals are deflected, the more force is applied. A TRIM DISENGAGE button is located on the pilot and copilot cyclic stick grips. Pressing and holding the TRIM DISENGAGE button will immediately reduce the forces on the pedals to zero. Releasing the button reengages the trim.

#### ***Tail rotor pitch limit system***

The SPUU-52-1 tail rotor pitch limit system uses a linear actuator linked to a mechanical stop to adjust the maximum tail rotor blade pitch angle within a range of  $16^{\circ}20'$  to  $20^{\circ}30'$ . The adjustment is based on air temperature and density:

- increased density (low altitude or/and low temperature) results in a decrease in the maximum blade pitch angle,
- decreased density (high altitude or/and high temperature) results in an increase in the maximum blade pitch angle.

When the system is disengaged, the stop resets and allows full right pedal travel.

The tail rotor pitch limit system is controlled and monitored via the SPUU-52-1 control panel. The panel is located in the right center area of the cockpit center console. The main power switch for the system is located on the pilot's left triangular panel. When the system is disengaged, the red OFF lamp-button on the control panel will illuminate. To engage the system, set the SPUU-52-1 main power switch to the ON (up) position.

When the right pedal is fully pressed in, the AFCS heading channel disengages.



**Fig. 5.18. SPUU-52-1 cockpit controls**

If the SPUU-52-1 system fails in flight, the red OFF lamp-button on the control panel will illuminate. In this case, the SPUU-52-1 main power switch on the left triangular panel should be set to the OFF (down) position. This will set the limiter needle on the SPUU-52-1 control panel to the full left position, indicating the removal of limits on right pedal travel. Hover and landing with the limiter disengaged should be performed as much as possible into the wind while avoiding large or sudden pedal inputs.

#### ***Directional control system failure in flight***

In case of directional control system failure in flight, the helicopter exhibits a strong tendency to yaw left and, if roll angle is maintained neutral, a tendency to sideslip right and turn left.

If the helicopter does not respond to pedal input, maintain an airspeed of 60-200 km/h and establish a right roll angle to maintain forward flight. Optimal airspeed is approximately 150 km/h, which produces minimal sideslip with a roll angle of 5-7° right in forward flight.

Test the helicopter response to pedal input throughout the pedal travel range in case limited control is possible within a specific input range. Attempt to find a suitable landing area allowing for a landing with an airspeed of 70-80 km/h.

Perform transitional maneuvers with gradual adjustments of collective control. When raising collective, the cyclic requires adjustment to the right and increased right roll angle. When lowering collective (for example to make a landing attempt), the cyclic requires adjustment to the left and reduced right roll angle.

Perform turns and heading changes using roll control. Turns are best performed to the left.

Once a suitable landing area is selected, begin a descent maintaining an airspeed of 150 km/h with 3-4 m/s descent rate.

At an altitude of 25 - 30 m, begin an aggressive deceleration. In the deceleration avoid left yaw by measured and if necessary progressive reductions in collective pitch.

At an altitude of 10 - 15 m, while continuing to decelerate, quickly reduce collective pitch by 1.5 - 2.5° and level out any present roll. As collective is reduced, the



helicopter tends to yaw right and reduce slip (drift) angle. Control the rate of descent and slip visually by referencing the ground and using collective pitch.

At an altitude of 3 - 4 m, increase collective pitch to establish a rate of descent of 1 - 2 m/s at touchdown. Keep in mind that yaw and slip/drift response occurs 1 - 2 sec after collective increase.

After touchdown reduce collective pitch to minimum.

### **5.2.3. Collective Pitch Control System**

The collective pitch control system includes integrated throttle and main rotor collective pitch control linkages. The collective inputs raise or lower the swashplate slide. This changes the pitch of the main rotor blades, causing an increase or decrease in lift on the entire rotor disc. When the collective stick is moved upward, main rotor collective pitch increases. At the same time, the engines increase to a higher power setting. When the collective stick is moved downward, main rotor pitch and engine power decreases. The collective control inputs reach the main engine throttle controls via a series of bellcranks and push rods. The collective inputs to the main rotor swashplate slide are routed via bellcranks and push rods to the collective flight control servo and collective lever/rocker.

The collective sticks are mounted on the cockpit floor to the left of the pilot's and copilot's seats. A hydraulic clutch holds the stick securely in any position, allowing the pilot to make smooth pitch adjustments and preventing the stick from creeping. Ordinarily, the clutch is adjusted manually using the handwheel to allow the stick to be moved, without releasing the clutch, with a force of 45 to 55 lb. The CLUTCH RELEASE button activates the hydraulic clutch release system, allowing the stick to be moved with a force no greater than 3.3 lb. When the button is released, the clutch re-engages. The CLUTCH RELEASE button also disengages the autopilot altitude channel.

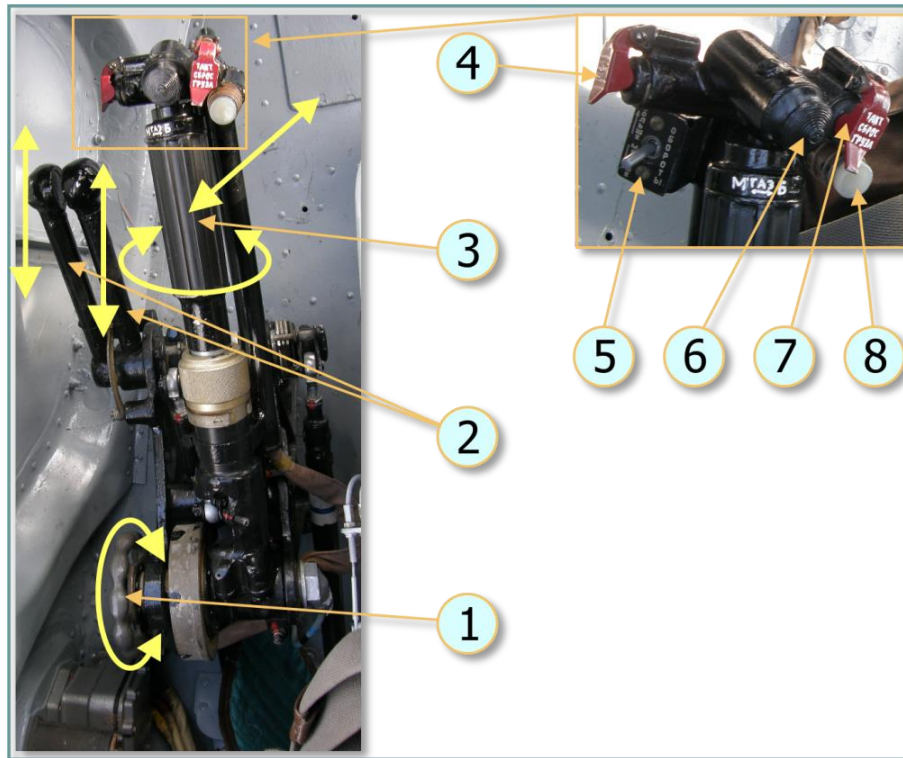

**Fig. 5.19. Pilot's (left) collective control group**

- |                                   |   |
|-----------------------------------|---|
| 1. Hand wheel (friction adjust)   | 5. N2 trim INCR-DEC switch                  |
| 2. Engine condition levers (ECLs) | 6. Searchlight control button               |
| 3. Twist throttle                 | 7. Tactical external stores jettison button |
| 4. Emerg cargo release button     | 8. CLUTCH RELEASE button                    |

The copilot's collective stick is located to the left of the copilot seat. It is similar in design to the pilot's collective, but does not include a friction clutch, cargo release buttons, or engine condition levers (ECLs).

Joint (dual) engine operation is controlled using the twist grip throttle control on the pilot or copilot collective sticks. The throttle is rotated right (clockwise) from the closed position through an idle detent, to fully open.

The engines are controlled individually by the pilot's ECLs. The ECLs vary the engine compressor (N1) control lever (throttle) settings from minimum to maximum power separately for each engine. They are used to control the engine power setting during ground testing and in special flight conditions, such as failure of one engine. The normal position of the ECLs is in the center detents. The engines can be brought to takeoff power by moving the engine condition levers to the maximum settings.

The collective control system is a reserve, manual method of rotor RPM control. Under normal conditions, rotor RPM is maintained automatically by the engine governor system.

Transition between automatic and manual rotor RPM control is accomplished using the twist throttle. When the throttle is fully open, the governor system automatically maintains rotor RPM. Twisting the throttle left (counterclockwise) disengages

automatic RPM control. The transition can be verified by reducing rotor RPM as the throttle is twisted further left.

To assist with setting a nominal rotor RPM of 95% for takeoff, the collective control handle features the N<sub>2</sub> trim INCR-DECR switch to allow for gradual adjustment of the engine power turbine RPM.

### 5.3. Powerplant and helicopter systems controls and indicators

#### 5.3.1. ИТЭ-2Т (ITE-2T) Dual engine tachometer

The dual tachometer is used to monitor compressor (N1) RPM of each engine. Rotational speed is expressed as a percentage of maximum speed. The "1" needle indicates left engine RPM and the "2" needle indicates right engine RPM. The scale range is 0 - 110%, graduated to 1%.

The tachometer is located in the bottom left area of the pilot's instrument panel. A second engine dual tachometer is located on the copilot's instrument panel. The tachometers receive power from the tach generators mounted on the engine accessory drives, one on each engine.



Fig. 5.20. Pilot's and copilot's dual engine tachometers

#### 5.3.2. ИТЭ-1Т (ITE-1T) Main rotor tachometer

The tachometer is located in the left center area of the pilot's instrument panel. The main rotor tachometer is used to monitor the main rotor RPM. Rotational speed is expressed as a percentage of maximum speed. A second main rotor tachometer is located in the right center area of the copilot's instrument panel. The tachometers receive power from the tach generators mounted on the main transmission.

The scale range is 0 - 110%, graduated to 1%.



Fig. 5.21. Pilot's and copilot's main rotor tachometers

### 5.3.3. ЭМИ-3РИ (EMI-3RI ) Engine oil pressure/temperature gauge

The engine oil pressure/temperature gauges, one for each engine, are mounted on the center console.

The gauge has three scales. The upper scale is not used. The lower left scale displays the oil pressure on a scale of 0 to 8 kg/cm<sup>2</sup>. The lower right scale displays the oil temperature in degrees centigrade on a scale of -70°C to +150°C.



Fig. 5.22. Oil pressure/temperature gauges, center console

### 5.3.4. ЭМИ-3РВИ (EMI-3RVI) Three pointer drive system oil pressure/temperature gauge

The drive system oil pressure and temperature gauge is installed on the left of the upper section of the center console. The gauge has three scales. The upper scale displays the oil pressure in the main transmission in kg/cm<sup>2</sup>. The lower left scale displays the oil temperature in the intermediate gearbox while the lower right scale displays the oil temperature in the tail rotor gearbox.





**Fig. 5.23. Three pointer drive system oil pressure/temperature gauge, center console**

The gauges receive temperature indications from oil temperature probes installed in the transmission gearboxes. Pressure indications are provided by a pressure transducer in the transmission oil system.

All temperature indications are in degrees centigrade. The pressure scale displays the oil pressure on a scale of 0 to 8 kg/cm<sup>2</sup>, graduated to 0.5 kg/cm<sup>2</sup>. The temperature scale displays the oil temperature in degrees centigrade on a scale of -70°C to +150°C, graduated to 10°C.

### 5.3.5. 2УТ-6К (2UT-6K) Power turbine inlet temperature (PTIT) gauge

The power turbine inlet temperature (PTIT) gauge is located in the lower center area of the pilot's instrument panel. The indicator receives temperature indications from the thermocouple probes mounted on the engine power turbine housings. The gauge has two scales for each engine. The large scales read in hundreds of degrees; the small scales read in 5 degree increments. The temperature indications are in degrees centigrade.



**Fig. 5.24. PTIT gauge**

The HOT ("ВОЗДУХ") and COLD ("ЗЕМЛЯ") test buttons, located on the pilot's left console, are used to confirm proper operation of the gauge. With the engines shut down, the needles should move toward 960° when the COLD button is pressed. The needles should return to zero when the COLD button is released. With the engines running, the needles should move toward zero when the HOT button is pressed and return to the actual PTIT readings when it is released.



### 5.3.6. IP-117 (IR-117) Engine pressure ratio (EPR) indicator

The engine pressure ratio indicator is located in the lower left area of the pilot's instrument panel. It is used to monitor the engine power settings. The indicator displays current engine compressor delivery pressure in reference to takeoff, nominal, and cruise power settings under current ambient atmosphere conditions.



**Fig. 5.25. Engine pressure ratio (EPR) indicator**

The indicator is connected to a pair of pressure tubes, an altitude sensor, and an outside air temperature probe. The power setting is determined by comparing the compressor delivery pressure pointers on the side indices (one for each engine - LH and RH) with the power setting pointers displayed in the center scale. The position of the power pointers in the center scale is proportional to the atmospheric pressure and ambient temperature. The center pointer marks "O", "H", and "K" correspond to takeoff, nominal, and cruise power settings, respectively. The indicator is scaled from 5 to 10 atmospheres.

The EPR indicates total power demand response to throttle, ECL, and collective input. Actual power output is determined by the alignment of the two outer markers with the center index, marked "O", "H", and "K".

The EPR indicator is used to monitor engine power settings in ambient air temperatures of up to +24°C. Above this temperature, the dual engine tachometer is used as the engine power settings indicator.

The reading error is  $\pm 1.5\%$ , measured pressure range is 4.6 - 8.5 atmospheres, effective operational altitude range is 0.5 - 2.5 km.

### 5.3.7. ТУЭ-48 (TUE-48) Main transmission oil temperature gauge



Fig. 5.26. Main transmission oil temp gauge, center console

The main transmission oil temperature gauge displays the oil temperature in degrees centigrade. The gauge is scaled from  $-50^{\circ}\text{C}$  to  $+150^{\circ}\text{C}$ , graduated to  $10^{\circ}\text{C}$ .

### 5.3.8. ТВ-19 (TV-19) Cargo cabin temperature gauge



Fig. 5.27. Cargo cabin temp gauge (TODO: New left picture)

The cargo cabin temperature gauge displays the cargo compartment temperature in degrees centigrade. The gauge is scaled from  $-60^{\circ}\text{C}$  to  $+70^{\circ}\text{C}$ , graduated to  $5^{\circ}\text{C}$ .

### 5.3.9. ТСТ-2 (TST-2) APU exhaust gas temperature (EGT) gauge



Fig. 5.28. APU EGT gauge, center overhead console

The APU exhaust gas temperature gauge is located in the upper right corner of the center overhead console, to the left of the APU air pressure gauge. The gauge reads in degrees centigrade. Gauge readings must be multiplied by 100 to obtain the correct temperature. The gauge is scaled from 0 to 900°C, graduated to 20°C.

During APU start, the EGT should not exceed 880°C. Normal EGT readings should be between 720 and 750°C.

### 5.3.10. УИ1-3 (UI1-3) APU air pressure gauge



Fig. 5.29. APU air pressure gauge, center overhead console

The APU air pressure gauge is located in the upper corner of the center overhead console, to the right of the APU EGT gauge. The gauge displays the pressure in the main bleed air channel of the AI-9V APU feeding the SV-78B air starters of the TV3-117VM engines.

The gauge reads in  $\text{kg}/\text{cm}^2$ . The gauge is scaled 0 to 3  $\text{kg}/\text{cm}^2$ , graduated to 0.2  $\text{kg}/\text{cm}^2$ .

### 5.3.11. УИ1-100 (UI1-100) Hydraulic pressure gauges

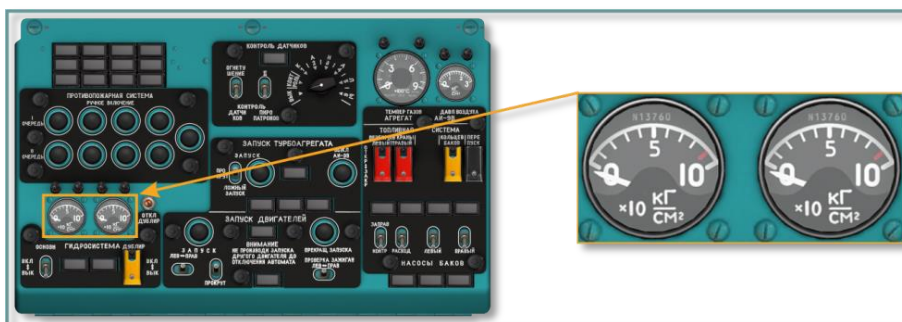

Fig. 5.30. Hydraulic pressure gauges, center overhead console

The MAIN and BACKUP system hydraulic pressure gauges are located in the lower left area of the center overhead console. The gauges display the system pressure in  $\text{kg}/\text{cm}^2$ . Scale indications must be multiplied by 10 to obtain the correct pressure reading. The gauges are scaled 0 to 100  $\text{kg}/\text{cm}^2$  graduated to 10  $\text{kg}/\text{cm}^2$ . Normal readings should be in the range of 45 to 68  $\text{kg}/\text{cm}^2$ .

### 5.3.12. УП-21-15 (UP-21-15) Rotor pitch indicator



Fig. 5.31. Rotor pitch indicator

The rotor pitch indicator is used to display the collective pitch of the main rotor in degrees. It is located on the left side of the pilot's instrument panel. The indicator is scaled 1° to 15°, graduated to 1°.

### 5.3.13. СКЭС-2027В (CKES-2027B) Fuel quantity gauge



Fig. 5.32. Fuel quantity gauge

The fuel quantity gauge and selector are located in the lower left corner of the copilot's instrument panel. The gauge continuously indicates the quantity of fuel in the selected tank in liters. The fuel gauge is connected to the fuel sensors installed in the individual fuel cells. The gauge has two indicator scales. The outer scale displays the total quantity of fuel in all tanks. The inner scale shows the fuel quantity in the selected tank. The selector position controls the active scale. The selector positions, from left to right, include "ВЫК" (OFF), "СУММА" (TOTAL), "Пл" (LEFT MAIN), "Ппр" (RIGHT MAIN), "РАСХ" (SVC CELL), "Д" (LEFT AUX – not modeled in DCS: Mi-8MTV2) positions. The scale indications must be multiplied by 100 liters to obtain the correct quantity of fuel.

The "ОСТАЛОСЬ 270л" (270 L FUEL) warning light is located on the copilot's instrument panel, above the fuel gauge. The low level transmitter activates when there are approximately 270 liters of fuel remaining in the SVC cell.

### 5.3.14. ИВ-500Е (IV-500E) Engine vibration monitor

The engine vibration monitor activates the caution and warning lights on the pilot's master caution panel if the vibration increases significantly or reaches a critical level.



If the level of vibration reaches 45 mm/s (1.8 in/s), the system illuminates the yellow caution light labeled "ЛЕВ (ПРАВ) ДВ ВИБР ПОВ" (LEFT (RIGHT) ENG HIGH VIBE). It also sends a signal to the audio warning system which transmits an audio warning over the helicopter intercom system. If the level of vibration reaches 60 mm/s (2.4 in/s), it illuminates the red warning light labeled "ВЫКЛЮЧИ ЛЕВ (ПРАВ) ДВ" (SHUT OFF LEFT (RIGHT) ENG) and sends a signal to be recorded by the flight parameter recorder.

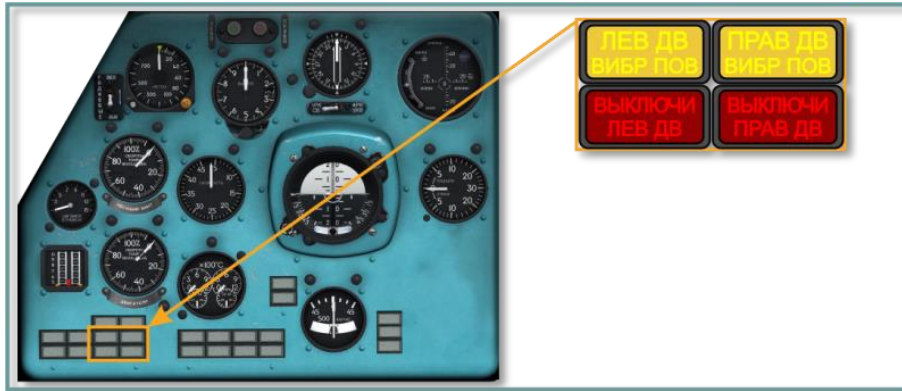

**Fig. 5.33. Engine vibration monitor annunciators**

The vibration monitor system includes a built-in test circuit. When the "КОНТРОЛЬ ИВ-500Е" (ENGINE VIBE TEST) button on the pilot's left side console is pressed, all four caution/warning lights must illuminate.

If the "ВЫКЛЮЧИ ЛЕВ (ПРАВ) ДВ" (SHUT OFF LEFT (RIGHT) ENG) light illuminates, attempt to reduce vibration by lowering the engine power settings. If the warning extinguishes, maintain 130-140 km/h and proceed to the nearest airfield.

If the warning persists, the faulty engine must be shut down. Flashing of both yellow and red annunciators is permissible in a power-on glide.

IV-500E technical specifications:

- monitored frequency range: 190 - 340 Hz
- monitored vibration speed range: 5 - 100 mm/s
- continuous operating duration: 10 h.

### 5.3.15. МВУ-100К (MVU-100K) Pneumatic system pressure gauge

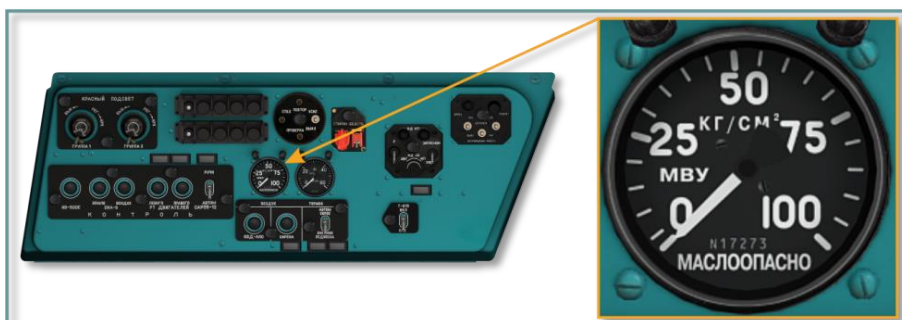

**Fig. 5.34. Pneumatic system pressure gauge, left side panel**



The pneumatic system pressure gauge is located on the left side console next to the brake pressure gauge. The gauge displays pressure in the pneumatic system in  $\text{kg}/\text{cm}^2$ . Normal reading is  $40\text{-}50 \text{ kg}/\text{cm}^2$ . The gauge is scaled 0 to  $100 \text{ kg}/\text{cm}^2$ , graduated to  $5 \text{ kg}/\text{cm}^2$ .

### 5.3.16. MA-6K (MA-6K) Brake pressure gauge



Fig. 5.35. Brake pressure gauge, left side panel

The brake pressure gauge is located on the left side console next to the pneumatic system pressure gauge. The gauge displays pressure in the main brake line in  $\text{kg}/\text{cm}^2$ . Normal reading is  $30\text{-}36 \text{ kg}/\text{cm}^2$  when the brakes are applied.

The gauge is scaled 0 to  $60 \text{ kg}/\text{cm}^2$ , graduated to  $2 \text{ kg}/\text{cm}^2$ .

## 5.4. Flight data and Navigation Systems controls and indicators

Flight data and navigation equipment includes flight instruments and related gauges, clock, and the AP-34B autopilot (described in chapter [7.11](#)).

### 5.4.1. Pitot static system



Fig. 5.1. Left and right pitot tubes

Two ПВД-6М (PVD-6M) pitot tubes are installed on the left and right side of the fuselage nose. The pitot tubes supply both dynamic (impact) pressure of the incidental airflow and static (ambient) air pressure. Static pressure is provided via a series of eight static pressure ports spaced around the aft circumference of the pitot tubes. To increase reliability, the static ports are connected to the

instruments through a 3-position switch. The pitot tubes are equipped with electrical heaters to protect them from freezing.

**Static port switching valve.** The static port switching valve allows the pilot to select a specific port or both ports as the source of static pressure for the instruments. The static port switching valve is mounted at the lower left corner of the pilot's instrument panel. With the lever set to the "O" (BOTH) (middle) position, static pressure from the left and right ports is combined by the valve and supplied to all of the connected instruments. When the lever is placed in the "Л" (LEFT) or "П"

(RIGHT) position, static pressure is supplied only from the left or right port, respectively. The left pitot tube supplies only the left (pilot's) airspeed indicator. The right pitot tube supplies the right (copilot's) airspeed indicator and the ДАС (DAS) airspeed sensor and КЗСП (KZSP) airspeed correction unit.

The pitot tubes are equipped with heaters to prevent obstruction of the inlets by ice. The heaters are controlled by the "ОБОГРЕВ ПВД ЛЕВ (ПРАВ)" (LEFT (RIGHT) PITOT HEAT) switches on the copilot's right side console.

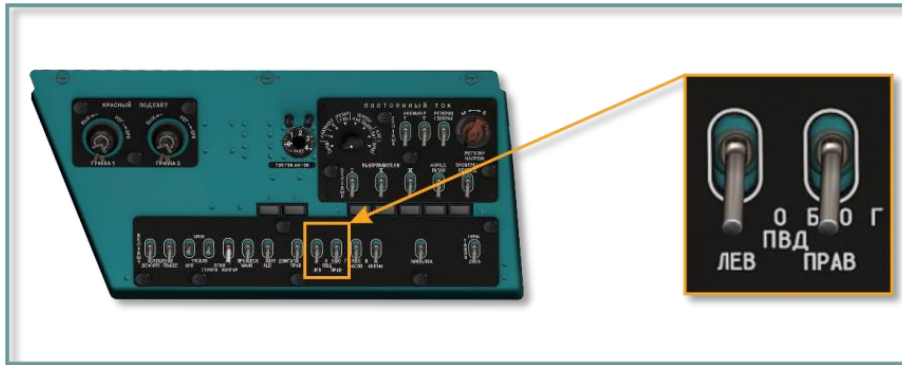

Fig. 5.36. Pitot tube heat switches, right side panel

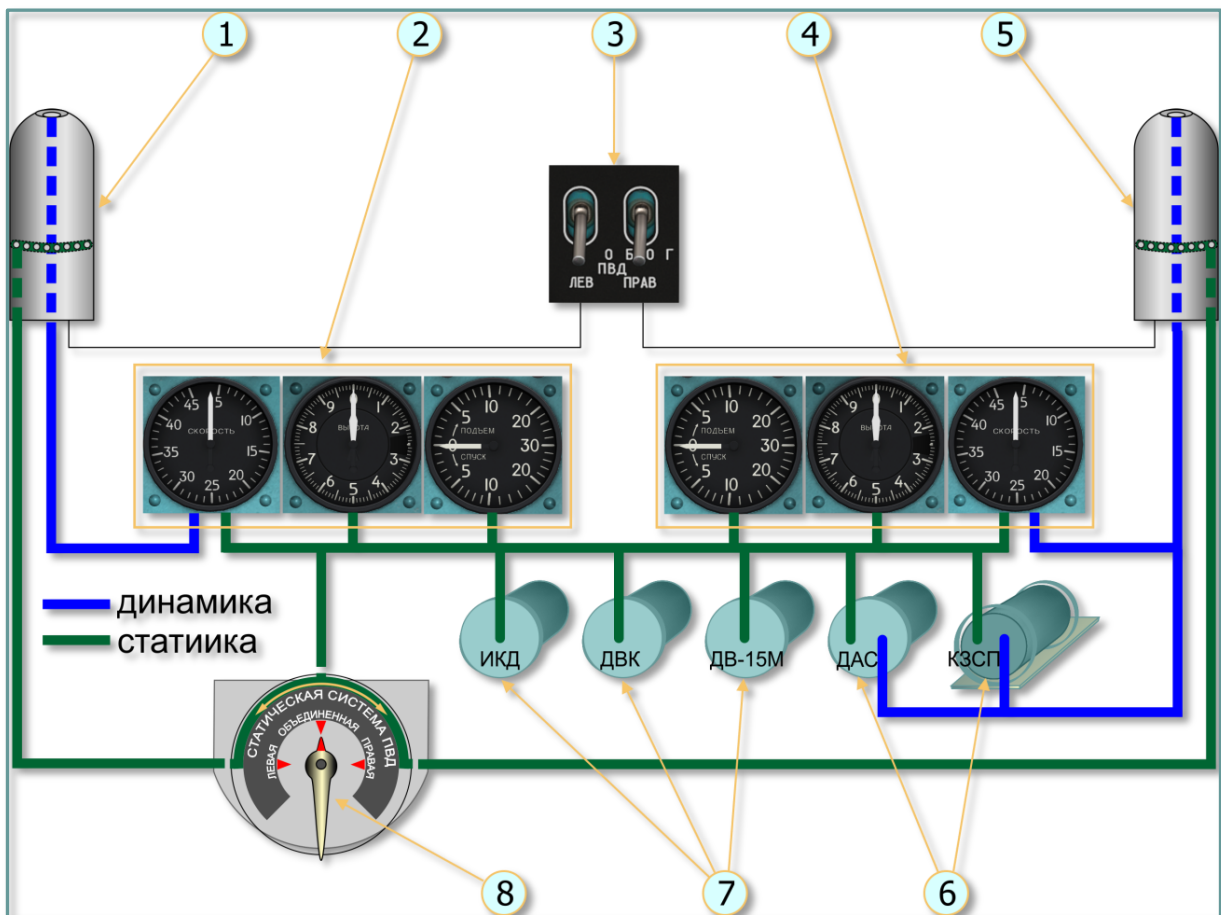

Fig. 5.37. Pitot static system diagram

- |  |                            |
|--|----------------------------|
| 1. Left pitot tube                                 | 5. Right pitot tube        |
| 2. Pilot's airspeed indicator, pressure altimeter, | 6. Pressure data consumers |

and vertical velocity indicator  
 3. Pitot tube heat switches  
 4. Copilot's airspeed indicator, pressure altimeter, and vertical velocity indicator

7. Pressure data consumers  
 8. Static port switching valve.

The pitot heaters have a built-in test circuit consisting of a "КОНТРОЛЬ ОБОГРЕВА ПВД" (PITOT HEATER TEST) button, a "ОБОГРЕВ ИСПРАВЕН" (HEATER OK) indicator light, and a relay and microswitch for each pitot tube. The test buttons and lights are located on the left and right triangular panels in the cockpit.



Fig. 5.38. Pitot heat test buttons and HEATER OK annunciators

#### 5.4.2. УС-450К (US-450K) airspeed indicator



Fig. 5.39. Airspeed indicators

Two airspeed indicators are installed on the helicopter, one on the pilot's instrument panel and one on the copilot's instrument panel. The airspeed indicators display the indicated airspeed in a range of 0 to 450 km/h on a scale graduated to 10 km/h.

#### 5.4.3. ВД-10К (VD-10K) pressure altimeter

Two pressure altimeters are installed on the helicopter, one on the pilot's instrument panel and one on the copilot's instrument panel. The pressure altimeters display barometric altitude. The indicators utilize two arrows: the large arrow displays altitude in meters, the small arrow in thousands of meters (kilometers). The indicator reading range is 0 to 10,000 m. The scale is graduated to 10 m for the large arrow and 100 m for the small arrow.



**Fig. 5.40. Pressure altimeters**



**Fig. 5.41. Pressure altimeter function elements**

- |                                     |                          |
|-------------------------------------|--------------------------|
| 1. Triangular index thousand meters | 5. Arrow thousand meters |
| 2. Triangular index hundred meters  | 6. Arrow hundred meters  |
| 3. The scale of the altimeter       | 7. Adjustment knob       |
| 4. The scale of pressure (mm Hg)    |                          |

The pressure altimeter adjustment knob is used to set the arrows to 0 altitude and adjust the reference barometric pressure. Turning the knob also moves the two triangular indexes around the altitude scale, one around the outside scale and one around the inside scale. The indexes are used to set the altitude difference for a landing point located at a higher elevation than the takeoff airfield in case the actual pressure at the landing field is unknown. [Fig. 5.42](#) shows an example, the setting helipad altitude 3.400m using a adjustment knob (triangular indices (1) and (2) set on 3400 m altitude). The arrows indicates the barometric altitude regarding this helipad (50 m).





Fig. 5.42. Setting helipad altitude using adjustment knob

#### 5.4.4. BP-30MK (VR-30MK) vertical speed indicator (VSI)



Fig. 5.43. Vertical speed indicator (VSI)

The vertical speed indicator (VSI) is mounted in the pilot's instrument panel. It displays the helicopter's rate of ascent/descent in a range of  $\pm 30$  meters per second (m/s) on a scale graduated to 1 m/s. The indicator is actuated by the rate of atmospheric pressure change. It is connected to the static pressure system.

#### 5.4.5. АГБ-3К (AGB-3K) attitude indicator

Attitude indicators are installed on both the pilot's and copilot's instrument panels. The indicators display the attitude of the helicopter (roll and pitch angles) relative to the horizon and sideslip.



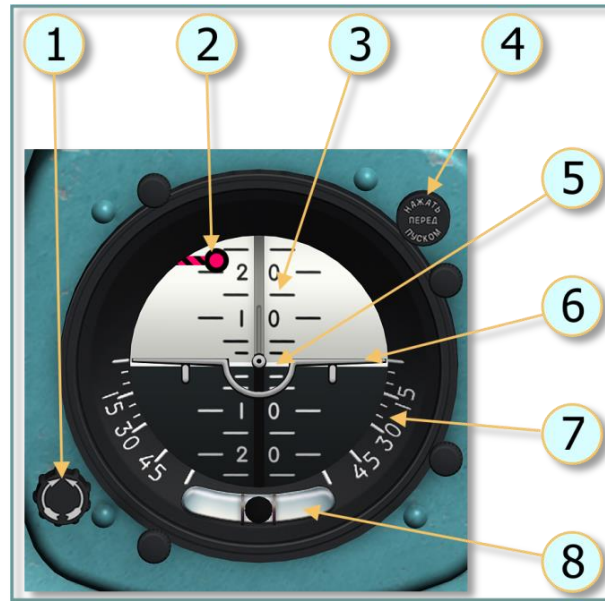

**Fig. 5.44. AGB-3K attitude indicator**

- |  |                     |
|--|---------------------|
| 1. Horizon elevation adjustment knob;            | 5. Horizon line;    |
| 2. Warning flag;                                 | 6. Aircraft symbol; |
| 3. Pitch scale;                                  | 7. Roll scale;      |
| 4. "APPETIP" (CAGE) button (press before start); | 8. Slip indicator   |

The pilot's AGB-3K attitude indicator supplies pitch and roll data to the flight data recorder and to the DISS-15D Doppler system. The copilot's attitude indicator supplies pitch and roll data to the autopilot system.

The attitude indicators utilize a free-mounted gyroscope with a three-phase gyromotor. Roll angles of  $85-87^\circ$  will cause the gyromotor to gimbal lock (lose one of three degrees of freedom).

A warning flag appears at the top of the instrument face in the event of power failure.

The gyromotor is connected to the BK-53PШ (VK-53RSh) gyro correction cutout switch to reduce accumulated error during prolonged unilateral acceleration (increasing speed, braking, and banked turns).

AGB-3K attitude indicator specifications:

- |   |               |
|---|---------------|
| time to readiness, no more than:                | 1.5 min       |
| error:  |               |
| ○ up to $30^\circ$ of deflection, no more than: | $\pm 1^\circ$ |
| ○ over $30^\circ$ of deflection, no more than:  | $\pm 2^\circ$ |

To test the AGB-3K attitude indicator:

- ensure AC and DC power is on
- press the "APPETIP" (CAGE) button on the indicator (all three axes of the gyroscope are set perpendicular to each other);

- turn on the "АВИАГОРИЗОНТ" (GYRO HORIZON) switch on the left and right triangular panels;
- verify the indicator functionality (flags should stow away).

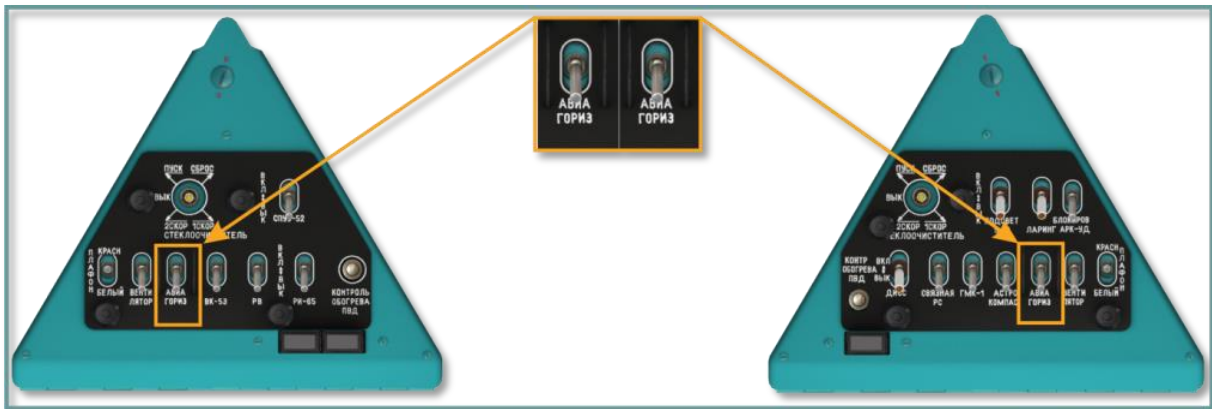

**Fig. 5.45. "АВИАГОРИЗОНТ" (GYRO HORIZON) switches on the left and right triangular panels**

A failure of the copilot's (right) attitude indicator will result in the failure of the АПБ-34Б (APB-34B) autopilot system. Use the pilot's (left) attitude indicator to continue the flight. The autopilot system is not designed to interact with the pilot's attitude indicator.

#### 5.4.6. ЭУП-53 (EUP-53) Turn and Slip indicator



**Fig. 5.46. Turn and slip indicator**

1. Display scale
2. Rate of turn needle
3. Slip ball

The turn and slip indicator is mounted on the pilot's instrument panel. The instrument scale displays in degrees with a range of  $\pm 45^\circ$  in  $15^\circ$  increments.

The indicator displays the helicopter's angular velocity around the vertical axis. Below the center of the indicator is a slip ball tube.

When performing properly balanced (coordinated) turns, the rate of turn needle indicates current bank angle.

The indicator utilizes rate gyros. It is powered with 27 VDC via the "УКАЗАТЕЛЬ ПОВОРОТА" (TURN IND) circuit breaker on the right circuit breaker panel.

One must take into account that while performing coordinated turns, readings of the EUP-53 turn and slip indicator are not corresponding to actual roll angles. Thus, while turning at a speed of 160-200 km/h with roll angle of 5, 10 or 15°, readings of the turn and slip indicator will be 15-10, 30-25 or 45-35° correspondingly. Note, that due to high sensitivity of this indicator, it's needle will be constantly oscillating, therefore pilot must read average value.

#### 5.4.7. ГМК-1А (GMK-1A) gyromagnetic compass set

The GMK-1A gyromagnetic compass set is a direction sensing system which provides a visual indication of the helicopter heading, required turn angle, and magnetic or true navigation bearing. The system consists of a number of interconnected magnetic and gyroscopic devices. Course information is displayed on the УГР-4УК (UGR-4UK) directional gyros installed in both the pilot and co-pilot instrument panels.

The system is turned on by setting the "ГМК-1" (COMPASS SYSTEM) switch on the right triangular panel to the ON (up) position.

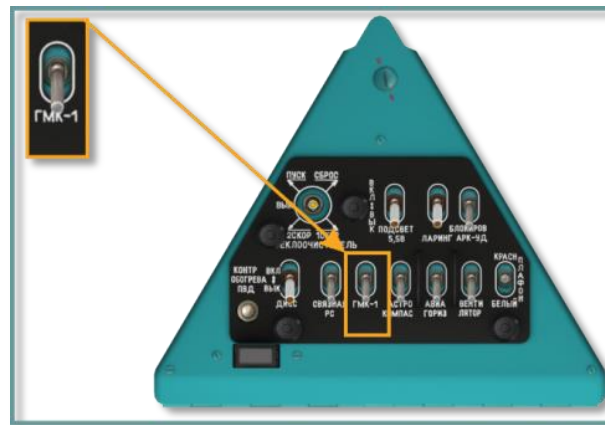

**Fig. 5.47. "ГМК-1" (COMPASS SYSTEM) switch, right triangular panel**

The ПУ-26 (PU-26) control panel located on the lower right corner of the right overhead console is used to:

- set the compass system operating mode ("МК" (MK, magnetic compass mode) or "ГПК" (GPK, directional gyro mode));
- input latitude correction using the "ШИПОТА" (LATITUDE) knob to correct for apparent drift due to the Earth's rotation;
- correct for mechanical drift due to friction and imperfect balancing within the gyro;
- set the assigned course on the directional gyro indicator using the "3К" (3K, assigned course) selector in GPK operating mode;
- perform fast alignment using the 3K selector in MK operating mode;
- monitoring and control of the system.



**Fig. 5.48. PU-26 control panel, right overhead console**

- |                                   |  |
|-----------------------------------|--|
| 1. "СЕВ-ЮЖН" (NORTH-SOUTH) switch | 4. "МК. ГПК. АМ" (MK-GPK-AK) mode selector |
| 2. "КОНТРОЛЬ" (TEST) selector     | 5. "ШИРОТА" (LATITUDE) knob                |
| 3. "ЗАВАЛ ГА" (BANK CORR) light   | 6. "3К" (assigned course) select or        |

The УГР-4УК (UGR-4UK) directional gyro displays the helicopter heading, required turn angles, and bearings. Two directional gyros are installed, one on the pilot's and one on the copilot's instrument panel. The helicopter heading is indicated by a moving compass card relative to a fixed index at the top of the compass. The compass card is graduated to 2° and marked numerically for each 30° (divided by 10).

Magnetic heading error does not exceed  $\pm 1.5^\circ$ .



**Fig. 5.49. UGR-4UK directional gyro**

In GPK mode, the cumulative error of the system does not exceed  $\pm 2,5^\circ$  per hour.

Time to readiness in MK mode does not exceed 3 min, in GPK mode does not exceed 5 min.

Normal alignment rate in MK mode is no less than  $1.5^\circ - 7^\circ/\text{min}$ . Fast alignment rate in MK mode is no less than  $6^\circ/\text{sec}$ . Alignment rate using the 3K switch is no less than  $2^\circ/\text{sec}$ .

The system utilizes a flux detector providing automatic magnetic heading corrections to the gyro, eliminating the need for frequent manual realignment. The system can operate in one of two modes: MK or GPK.

GPK is the primary mode, utilizing the flux detector and a magnetic deviation compensator to correct gyro drift. When operating in GPK mode, the gyro is the source of heading data.

The gyro gradually accumulates error in azimuth due to the earth's rotation (apparent drift) as well as mechanical friction and imbalances within the device (mechanical drift). The latitude corrector is used to correct these errors.

To select GPK mode, set the mode selector to the "ГПК" (GPK) position on the PU-26 control panel.

MK mode is used to align the gyro to the signal provided by the flux detector and magnetic deviation compensator. To select MK mode, set the mode selector to the MK position on the PU-26 control panel.

The system is initialized in MK mode to allow the unit to establish baseline heading data.

The gyro can be aligned at normal speed (via the 3K switch on the control panel) or fast speed.

Automatic fast alignment occurs whenever the operating mode is switched from GPK to MK.

Heading indication accuracy is checked periodically using the TEST switch. The switch is toggled to the 0° and 300° positions, the resulting indication cannot vary by more than +/- 10°. Testing the system must also illuminate the "ЗАВАЛ ГА" (BANK CORR) warning light.

Preparing the compass set for operation:

- set the "СЕВ-ЮЖН" (NORTH-SOUTH) selector to correspond to current hemisphere;
- set current latitude using the "ШИРОТА" (LATITUDE) knob;
- test the set using the "КОНТРОЛЬ" (TEST) switch;
- align the gyro to the correct magnetic heading by pressing the 3K switch (in MK mode) or by turning the compass card using the 3K switch until the correct heading is set (in GPK mode);
- verify proper alignment and correct magnetic heading prior to takeoff.

#### **5.4.8. КИ-13К (KI-13K) magnetic compass**

The magnetic compass is mounted on the center windshield left frame. The magnetic compass is used to indicate the magnetic helicopter heading and acts as an autonomous reserve heading indicator. The compass scale is graduated in 5° increments with number markings every 30°. The cardinal points are marked with Cyrillic characters: "С" - North, "Ю" - South, "В" - East, and "З" - West.





**Fig. 5.50. Magnetic compass**

Magnetic compass specifications:

- magnetic deviation (with no deviation compensator):  $\pm 1^\circ$ ;
- pivot friction: no more than  $1^\circ$ ;
- magnetic deviation on courses of  $0^\circ$ ,  $90^\circ$ ,  $180^\circ$ ,  $270^\circ$ : no more than  $\pm 2.5^\circ$ ;

The compass period (time required to settle oscillations) in temperatures of  $-60^\circ\text{C}$  to  $+50^\circ\text{C}$  is no greater than 17 seconds.

The compass is designed to function properly at roll angles of up to  $17^\circ$ .

*Because the magnetic compass displays a compass heading, local magnetic variation as well compass deviation must be corrected to determine required true heading.*

#### 5.4.9. A4C-1 (AChS-1) clock

The mechanical clock Molnija AChS-1 is installed on the copilot's instrument panel. The clock displays the current time of day in hours, minutes, and seconds. It can also be used to measure mission/flight time in hours and minutes, and as a chronometer to accurately measure short time periods (up to an hour) in minutes and seconds.



**Fig. 5.51. Clock**

The clock is equipped with electrical heating elements for cold weather operation. The clock heater is controlled by the "ОБОГРЕВ ЧАСОВ" (CLOCK HEAT) switch on the right side console. The heater allows clock operation at temperatures below  $+5^\circ\text{C}$ .

Operating in normal temperatures, the clock is accurate to  $\pm 20$  sec/24 hrs.

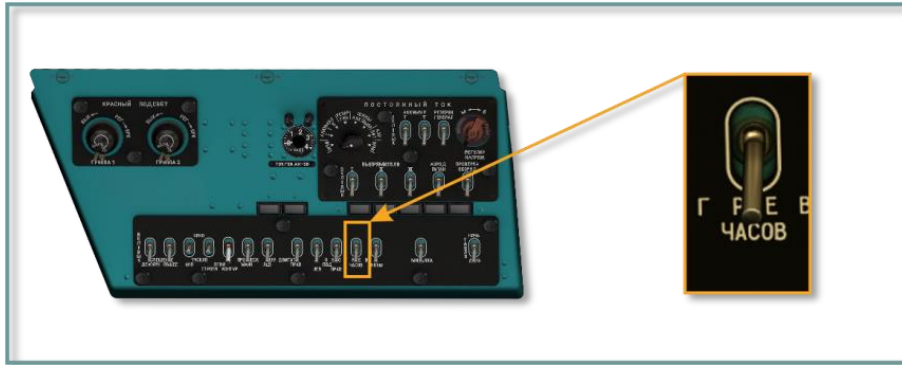

Fig. 5.52. "ОБОГРЕВ ЧАСОВ" (CLOCK HEAT) switch, right side console

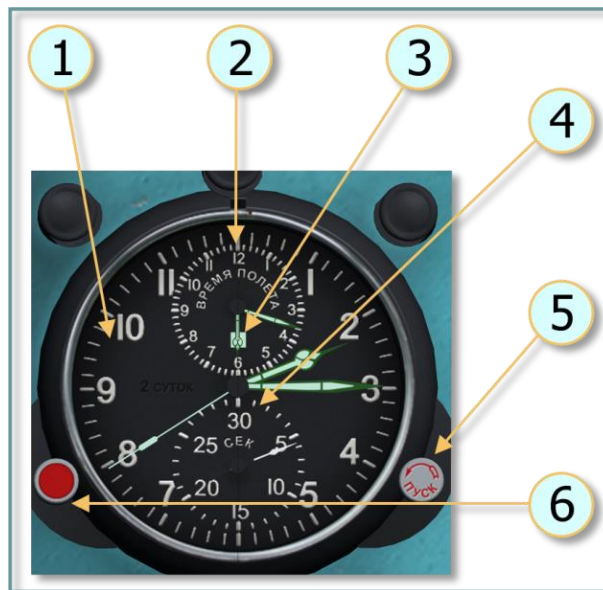

Fig. 5.53. Clock functional elements

- |   |   |
|---|---|
| 1. Outer dial and time-of-day clock hands | 4. Stopwatch clock dial                       |
| 2. 12 h mission (flight) time clock dial  | 5. right knob: clock / stopwatch start button |
| 3. Mode indicator window                  | 6. Left knob.                                 |

The time of day display operates continuously. Flight (mission) time can be activated as desired by pressing the left red knob (6) **[RALT + RCTRL + RSHIFT + C]**. The stopwatch can be activated as desired by pressing the right knob (5) **[RALT + RSHIFT + C]**.

To set the time, first stop the clock by rotating the right button crown (5), labeled ПУСК (START), clockwise **[RCTRL + RSHIFT + .]** when the second hand points to 12. Then pull the left button crown (6) **[RSHIFT + M]** while holding down the right mouse button, and rotate it counter-clockwise **[LALT + ,]** or clockwise **[LALT + .]** to set the desired time. Rotating the right button crown counter-clockwise **[RCTRL + RSHIFT + ,]** again resumes clock operation with the new time setting.

Flight (mission) time is indicated on the small scale at the top of the clock face. Flight time mode is indicated by the following three markings inside the mode indicator window (3):

- Red: Flight time is running.
- Red-white: Flight time is stopped.
- White: Flight time is reset (standby).

Press the left button **[RALT + RCTRL + RSHIFT + C]** to start the timer. The mode indicator window will show red and the timer will start ticking. To stop the timer, press the left button (6) again **[RALT + RCTRL + RSHIFT + C]**. The mode indicator window will show red-white. To reset the timer, press the left button once again **[RALT + RCTRL + RSHIFT + C]** or **[RSHIFT + M]**. The mode indicator will now show white.

The stopwatch (4) is the small scale at the bottom of the clock face and is used to accurately measure short time spans (up to 1 hour). It is controlled with the right button (5), in a similar fashion as the mission time clock: Press the right button to start the timer, press it again to stop the timer and press it once again to reset the timer.

The clock spring is wound manually by rotating the left button crown counter-clockwise to its mechanical stop. The spring contains enough energy for two days of operation.

#### 5.4.10. BK-53PШ (VK-53RSh) gyro correction cutout switch

The VK-53RSh gyro correction cutout switch is designed to automatically disable lateral gyro correction for the attitude indicator and gyro compass set gyroscopes to reduce accumulated error during prolonged unilateral acceleration (increasing speed, braking, and banked turns). Correction cutout occurs whenever angular velocity is greater than 0.3°/sec. Correction cutout does not occur from abrupt and unsustained changes in flight conditions.

The gyro correction cutout switch is turned on via the "BK-53" (VK-53) switch on the left triangular panel.

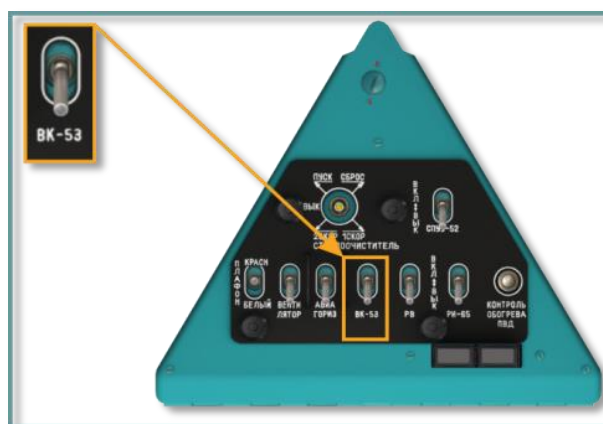

Fig. 5.54. "BK-53" (VK-53) gyro correction cutout switch, left triangular panel

VK-53RSh specifications:

Power voltage:	36 VAC $\pm$ 5% 3-phase power; 400 Hz; 27 VDC $\pm$ 10%.
Correction cutout angular velocity	0.3°/sec.
Duration of correction cutout	3 - 15 sec.
Time to readiness:	no more than 1 min
Mass:	2.7 kg

#### 5.4.11. G-load indicator

The accelerometer (or "G-meter") indicates the current maneuver loading on the helicopter; it is measured in regards to normal gravity (1G). The red needles indicate the highest and lowest G attained during a sortie. A button in the lower right



of the scale is used to reset the lowest and highest attained G

The scale starts at 1 G (the earth's normal gravity) and is demarcated from -1 to +3 G.

Reset needles button **[LShift + -]**.







## 6. RADIO COMMUNICATION AND NAVIGATION SYSTEMS

Radio communication and navigation systems of the Mi-8MTV2 include:

- voice communication systems
- radio navigation systems
- transponder and warning systems
- special purpose radio systems

Radio communication and navigation systems provide:

- communication between crew members
- communication with ground stations
- communication between aircraft
- transmission of audio warnings to crew members and ground control stations
- transmission of identification responses and emergency signals
- radio homing on navigation beacons

Electrical power to the radio systems is provided via:

- 28.5 VDC from three BY-6A (VU-6A) rectifiers, each rated at 6 kW
- 115 VAC 400 Hz single-phase TC/1-2 (TS/1-2) power transformer
- 36 VAC 400 Hz three-phase TC 330C04Б (TS 330S04B) power transformer

Emergency power sources:

- two 12CAM-28 (12SAM-28) batteries and the CTF-3 STG-3 AC generator
- ПO-500A (PO-500A) 115 VAC and ПТ-200Ц (PTs-200Ts) 36 VAC 400 Hz inverters

All radio equipment is housed in the tail cone, radio compartment, and cockpit.

### ***6.1. Radio communication systems***

Radio communication systems installed on the Mi-8MTV2 include:

- СПУ-7 (SPU-7) intercommunications set (ICS)
- P-863 (R-863) VHF/UHF command radio set (AM/FM 2-way air-to-ground and air-to-air communication)
- Ядро-1A (YaDRO-1A) HF radio set
- P-828 (R-828) LVHF radio set
- П-503Б (P-503B) recording equipment (not implemented)
- РИ-65 (RI-65) audio warning system
- commutation and volume leveling system

#### **6.1.1. СПУ-7 (SPU-7) intercommunications set (ICS)**

The SPU-7 intercommunications set (ICS) is a signal distribution system designed to provide internal crew communication, airwave transmission via the R-863, R-828, YaDRO-1A radio sets, monitoring of ADF code ID signals, as well as transmission of signals from the audio warning system and radar altimeter.

SPU-7 components:

- amplifier
- distribution unit
- control boxes for pilot and copilot located to the left and right of the circuit breaker consoles, respectively
- control box in the troop commander station in the cargo cabin, as well as the "ЛАРИНГ ВКЛ. - ВЫКЛ." (MIC) switch
- three additional ICS tie-in points:
  - crew chief station;
  - winch operator station;
  - tail gunner station;
- "ЛАРИНГ ВКЛ.- ВЫКЛ." (MIC) switch on the right triangular panel
- "СПУ – РАДИО" (ICS RADIO PTT) buttons on the pilot and copilot cyclic control stick
- "СПУ-7" (SPU-7) circuit breaker on the right circuit breaker panel

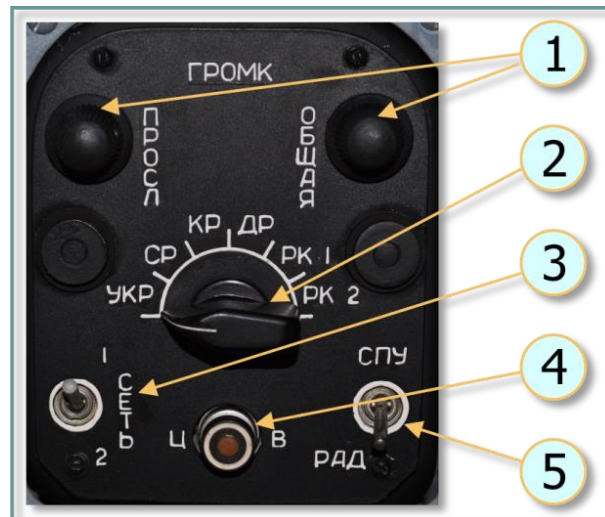

**Fig. 6.1. SPU-7 control panel**

- |   |  |
|---|--|
| <p>1. "ОБЩАЯ" (MASTER) and "ПРОСЛ" (MONITOR) volume control knobs to set volume of internal and external comms.;</p> <p>2. rotary selector to select source to monitor:</p> <ul style="list-style-type: none"> <li>▪ "УКР" (UHF) – R-863 UHF/VHF radio set</li> <li>▪ "СР" (HF) – YaDRO-1A radio set</li> <li>▪ "КР" (VHF) – R-828 UHF radio set</li> <li>▪ "ДР" (SW) – not utilized</li> <li>▪ "РК 1" (ADF) – ARK-9 ADF set</li> <li>▪ "РК 2" (SAR) – ARK-UD VHF homing set</li> </ul> | <p>3. "СЕТЬ 1-2" (NET 1-2) - not utilized;</p> <p>4. "ЦВ" (ALL CALL) button for transmission of emergency messages (when pressed, interphone signal is transmitted to all ICS stations at doubled volume level, audio warning messages are transmitted with maximum volume level);</p> <p>5. "СПУ-РАД" (ICS-RADIO) selects communication via ICS or the selected radio</p> |
|---|--|

### ***Features of the "СПУ-РАД" (ICS-RADIO) switch***

When this switch is set to the **СПУ (ICS) position** and the unified ICS RADIO PTT button on the pilot or copilot cyclic control stick is pressed to the first position (one click) or second position (second click) intercom is used. When this switch is set to the **РАД (RADIO) position** and the unified ICS RADIO PTT button on the pilot or copilot cyclic

control stick is pressed to the first position (one click), then intercom is used. When pressed to the second position (second click) - radio is used.

When in РАД (RADIO) position, broadcast transmissions are heard at a normal volume level, while crew is heard with reduced volume. To adjust volume, pilot should use the ОБЩАЯ (MASTER) and ПРОСЛ (MONITOR) knobs.

When the SPU-RAD switch is set to СПУ (ICS) position, intercom volume is controlled by the ОБЩАЯ (MASTER) knob and radio volume by the ПРОСЛ (MONITOR) knob.

When the SPU-RAD switch is set to РАД (RADIO) position, intercom volume is controlled by the ПРОСЛ (MONITOR) knob and radio volume by the ОБЩАЯ (MASTER) knob.

### 6.1.2. P-863 (R-863) VHF/UHF command radio set

The R-863 radio set provides two-way voice communications in the VHF range of 100 to 149.975 MHz and UHF range of 220 to 399.975 MHz in AM or FM modes. Minimum frequency separation between adjacent channels is 25 kHz. Frequency stabilization is achieved by means of a digital synthesizer which provides instant selection of 20 fixed frequencies that are preset on the ground (R-863 channel selector panel) or manual frequency control (R-863 frequency control unit). An emergency receiver built into the radio set provides standby reception of one preset emergency frequency (121.5 MHz or 243 MHz).



**Fig. 6.2. Left overhead console: R-863 "КОМАНД. РС АМ-ЧМ" (AM-FM) switch (FM up position, AM down position); R-863 "КАНАЛ" (CHANNEL) selector panel with 20 available channels**

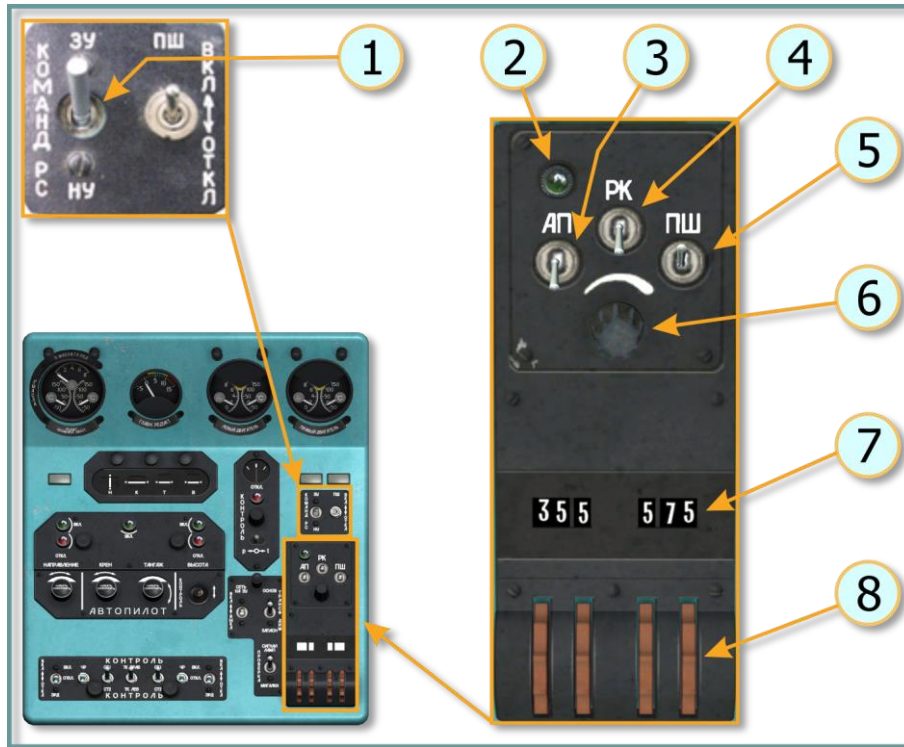

**Fig. 6.3. R-863 frequency selector unit**

1. "3У-НУ" (PRESETS-MANUAL) switch selects between preset channels and manual frequency control;
2. "АП" (EMERG) – lamp is not engaged on the Mi-8MT, -MTV2..5 because there is no emergency receiver;
3. "АП" (EMERG RCVR) – switch is not engaged on the Mi-8MT, -MTV2..5 because there is no emergency receiver;
4. "РК" (RK) switch is not used on the Mi-8MT, -MTV2..5
5. "ПШ" (SQUELCH) switch to activate the noise suppression circuit;
6. "РГ" (VOLUME) control knob;
7. Frequency scale (now 355.575 MHz);
8. Wheels for setting frequency.

*R-863 SPECIFICATIONS:*

Frequency range:	
VHF	100-149.975 MHz
UHF	220-399.975 MHz
Frequency separation	25 kHz
Number of discrete frequencies:	
VHF	2000
UHF	7200
Power output:	
VHF	10 W
UHF	8 W
Receiver sensitivity	3 $\mu$ V
Emergency receiver frequency:	
VHF	121.5 MHz
UHF	243 MHz
Frequency tuning time, no more than	1.5 sec
Time to readiness	5 min
Power voltage	28.5 V

*R-863 OPERATION:*

Turn ON the "КОМАНД. PC" (CMND RADIO) and "СПУ" (ICS) circuit breakers on the right circuit breaker panel. Set radio selector on the ICS control box to the "УКР" (VHF1) position and the "СПУ-РАДИО" (ICS-RADIO) selector to the RADIO (down) position. On the R-863 control panels:

- SQUELCH (AS) switch to the OFF (down) position
- AM-FM switch to the appropriate position for the desired channel
- CHANNEL selector to the desired channel
- volume control to maximum

In case of poor reception, turn off the squelch. To switch off the radio set, set the "КОМАНД. PC" (CMND RADIO) circuit breaker on the right circuit breaker panel to OFF (down).

Notes. 1. The АП (EMERG RCVR) switch, enabling the emergency receiver and corresponding lamp signalization when emergency signal is received, is not used, because there is no emergency receiver on this helicopter.

2. The PK (Radio compass) switch, enabling simultaneous listening of the ARK-9 signals, is not used, because they are listened via the SPU-7 intercom.

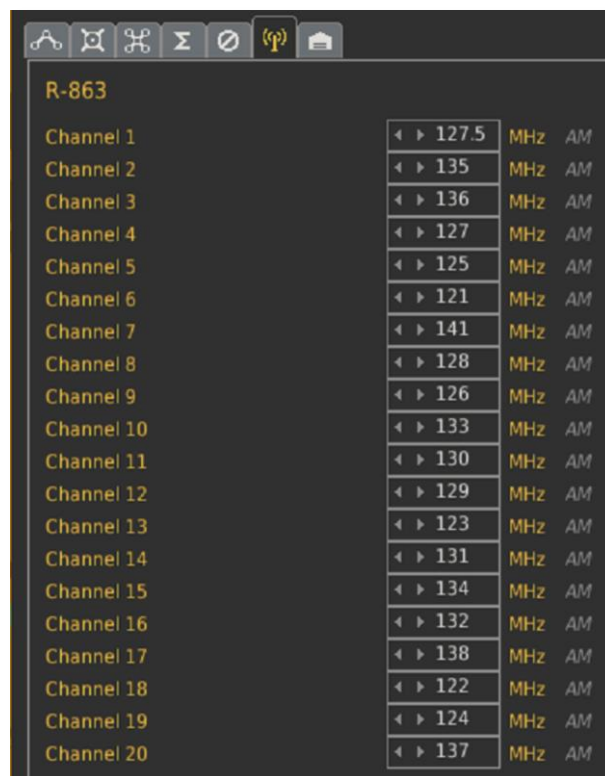
*CONFIGURING THE R-863 CHANNEL PRESET FREQUENCIES IN DCS:*

Channel	Frequency (MHz)	Modulation
Channel 1	127.5	MHz AM
Channel 2	135	MHz AM
Channel 3	136	MHz AM
Channel 4	127	MHz AM
Channel 5	125	MHz AM
Channel 6	121	MHz AM
Channel 7	141	MHz AM
Channel 8	128	MHz AM
Channel 9	126	MHz AM
Channel 10	133	MHz AM
Channel 11	130	MHz AM
Channel 12	129	MHz AM
Channel 13	123	MHz AM
Channel 14	131	MHz AM
Channel 15	134	MHz AM
Channel 16	132	MHz AM
Channel 17	138	MHz AM
Channel 18	122	MHz AM
Channel 19	124	MHz AM
Channel 20	137	MHz AM

**Fig. 6.4. The R-863 channel preset frequencies**

### 6.1.3. ЯДРО-1А (YaDRO-1A) HF radio set

The YaDRO-1A HF radio set is designed to provide simplex, fixed-tuned, air-to-ground and air-to-air voice communications. The radio set offers tuning in flight to



any communication frequency within a range of 2 to 17.999 MHz in 100 Hz increments in AM or SSB (single sideband) modes. The radio set operates via a wire antenna. The radio set is supplied with 27 VDC from the rectifier bus via the "CBЯ3H PC" (COMM RADIO) circuit breaker on the right circuit breaker panel, and with 115 VAC from the 115 VAC primary bus via a fuse located in the main fuse box.

*YADRO-1A COMPONENTS:*

- transceiver and automatic tuning control unit
- wire antenna (steel cable strung along the upper left and right sides of the tail boom to the outboard leading edges of the horizontal stabilizers)



**Fig. 6.5. Wire antenna**

- control panel located on the right auxiliary panel
- "CBЯ3H PC" (COMM RADIO) circuit breaker on the right circuit breaker panel

*YADRO-1A SPECIFICATIONS:*

Frequency range	2-17.999 MHz
Frequency separation	100 Hz
Effective range	no less than 900 km
Time to readiness	2 min
Continuous operation time	6 hrs
Receiver sensitivity:	
AM mode	5 $\mu$ V
SSB mode	3 $\mu$ V
Transmitter output power:	
below 12.000 MHz	100 W
in range 12.000 – 17.999 MHz	50 W
Frequency tuning time	5 sec
Power voltage	28.5 V

YaDRO-1A control panel:

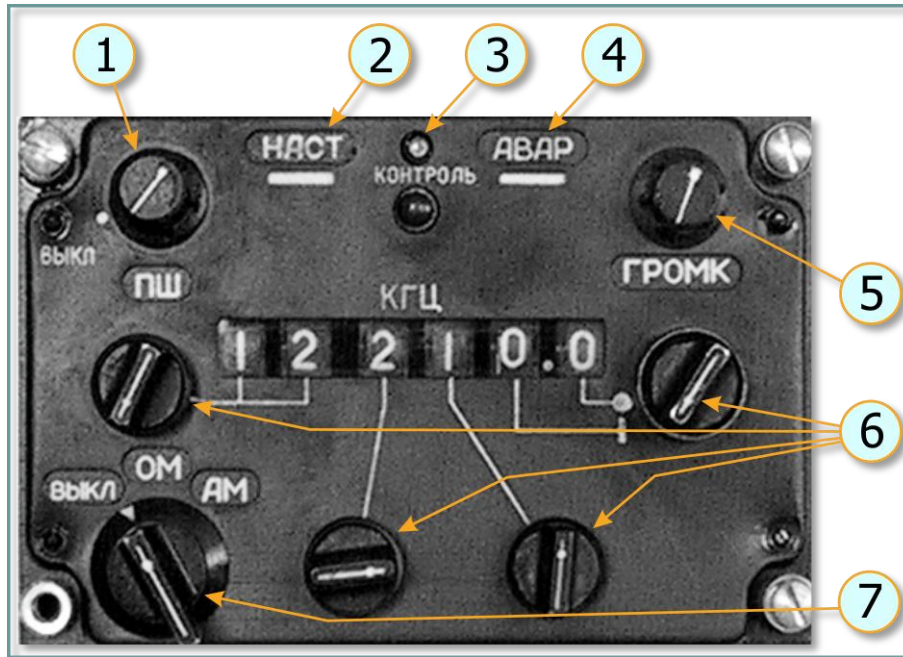

**Fig. 6.6. YaDRO-1A control panel**

- |  |   |
|--|---|
| <p>1. "ПШ" (SQUELCH) knob for incremental control of the noise reduction circuit;</p> <p>2. "НАСТ" (TUNING) light to indicate that the radio set is tuning;</p> <p>3. "КОНТРОЛЬ" (TEST) button and light to activate and indicate progress of the radio set self-test;</p> | <p>4. "АВАР" (EMERG) light to indicate the radio set is in emergency status;</p> <p>5. "ГРОМК" (VOLUME) control knob;</p> <p>6. Four knobs for frequency setting;</p> <p>7. Three position selector: "ВЫКЛ" (OFF) - radio set is switched off, "ОМ" (SSB), "АМ" (AM) - selection of operating mode.</p> |
|--|---|

#### *YADRO-1A OPERATION:*

Turn ON the "СВЯЗН РС" (COMM RADIO) and "СПУ" (ICS) circuit breakers on the right circuit breaker panel. Set radio selector on the ICS control box to the "СР" (HF) position and the "СПУ-РАДИО" (ICS-RADIO) selector to the RADIO (down) position. On the YaDRO-1A control panel:

- power up the radio set by setting the "ВЫКЛ. – ОМ – АМ" (OFF – SSB – AM) selector to the position corresponding to the desired mode of operation
- set the "ПШ" (SQUELCH) knob to the OFF position to disable the noise reduction circuit
- set volume control to maximum
- set the desired frequency using the frequency selection knobs. The "НАСТ" (TUNING) light will illuminate. Tuning should be complete within 5 seconds and the light should go off.

A built-in test facility is provided to check the serviceability of the receive, transmit, and tuning functions. The self-test is initiated by pressing the "КОНТРОЛЬ" (TEST) button. If the radio set is operational, the "КОНТРОЛЬ" (TEST) light will be on and noise heard in the headset when the radio is in receiving mode or a signal when it is in transmission mode.

To disable the radio set, set the "СВЯЗН РС" (COMM RADIO) circuit breaker on the right circuit breaker panel to OFF (down).

#### 6.1.4. P-828 (R-828) LVHF FM transceiver set

The R-828 LVHF FM transceiver set provides VHF homing in conjunction with the "АРК-УД" (ARK-UD) VHF homing set and standby 2-way voice communications. The radio provides instant tuning to one of ten frequencies preset on the ground. The frequency range is 20 - 59.975 MHz in 25 kHz increments.

The radio set operates in one of two modes: VOICE (voice communication) and HOMING (VHF homing using the ARK-UD system).

##### *R-828 COMPONENTS:*

- transceiver
- control panel located on the right auxiliary panel;
- "P-828 ВКЛ - ВЫКЛ" (R-828 RADIO) power switch and "P-828 КОМПАС-СВЯЗЬ" (R-828 VOICE-HOMING) mode switch located on the right auxiliary panel
- the NIPV-type antenna mounted at the bottom of the fuselage. The antenna-feeder system includes a phase sensor, an antenna matching device, and an automatic tuning control unit



**Fig. 6.7. NIPV-type antenna of the R-828 radio set**

##### *R-828 SPECIFICATIONS:*

Frequency range	20-59.975 MHz
Frequency separation	25 kHz
Time to readiness, no more than	3 min
Number of discrete frequencies	1600
Number of preset channels	10
Receiver sensitivity, at least	2 $\mu$ V
Transmitter output power	10 W
Effective range at altitude of 1000 m	120 km
Frequency tuning time, no more than	5 sec
Power voltage	28.5 V

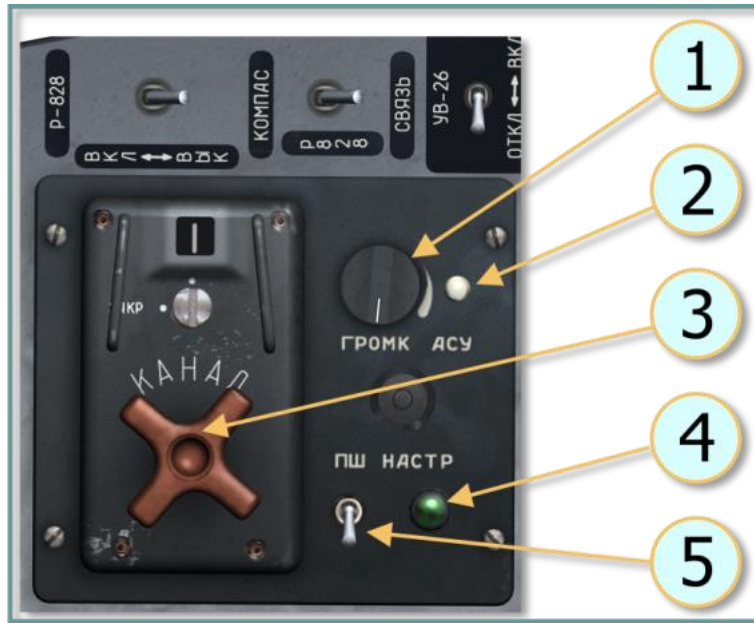

**Fig. 6.8. R-828 radio set control panel**

- |   |  |
|---|--|
| <p>1. "ГРОМК" (VOLUME) control knob;</p> <p>2. "АСУ" (AGC, automatic gain control) button to enable automatic gain control to adapt the output of the transmitter to the antenna;</p> | <p>3. "КАНАЛ" (CHANNEL) selector to set one of 10 preset frequencies;</p> <p>4. "НАСТР" (TUNING) light;</p> <p>5. "ПШ" (SQUELCH) switch.</p> |
|---|--|



**Fig. 6.9. R-828 power and mode switches**

- |  |  |
|--|--|
| <p>1. "P-828 ВКЛ – ВЫКЛ" (R-828 RADIO) power switch;</p> | <p>2. "P-828 СВЯЗЬ – КОМПАС" (R-828 VOICE-HOMING) mode switch.</p> |
|--|--|

*R-828 OPERATION:*

Turn ON the "СПУ" (ICS) circuit breaker on the right circuit breaker panel. Set radio selector on the ICS control box to the "КР" (KR) position and the "СПУ-РАДИО" (ICS-RADIO) selector to the RADIO (down) position.

On the right auxiliary panel:

- turn on (set forward) the "P-828 ВКЛ – ВЫКЛ" (R-828 RADIO) switch
- set the "P-828 СВЯЗЬ-КОМПАС" (R-828 VOICE-HOMING) switch to "СВЯЗЬ" (VOICE) (set back)

On the R-828 radio set control panel:

- "ПШ" (SQUELCH) switch OFF
- "ГРОМК" (VOLUME) control to maximum
- "КАНАЛ" (CHANNEL) selector to the desired channel. "НАСТР" (TUNING) light should turn on for 1-5 sec.

To disable the radio set, set the "P-828 ВКЛ – ВЫКЛ" (R-828 RADIO) switch to the "ВЫКЛ" (OFF) position (back).

To use the R-828 radio in conjunction with the ARK-UD homing set to home on to a ground station, first establish voice contact with the station and request a tone modulated signal from the ground station operator for the desired frequency. Once the tone signal is confirmed in the headset, set the P-828 СВЯЗЬ-КОМПАС" (R-828 VOICE-HOMING) mode switch to "КОМПАС" (HOMING). Observe the needle on the UGR-4UK directional gyro for signal bearing.

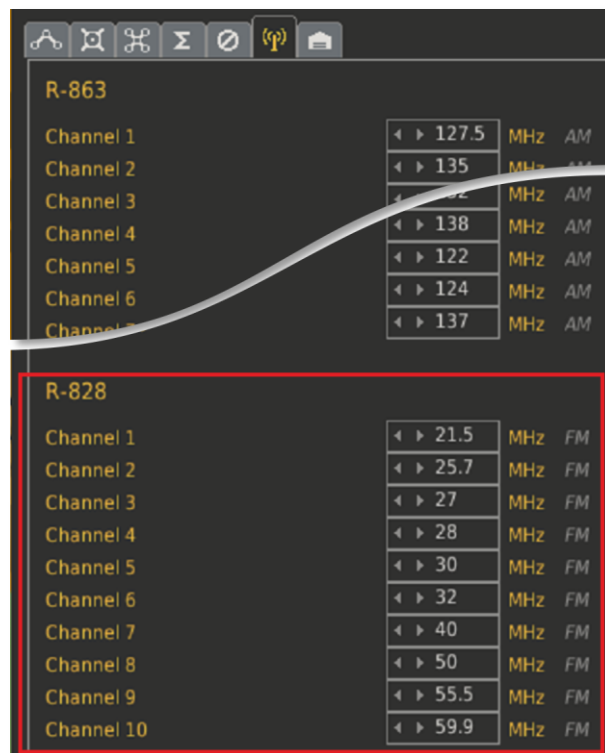
*CONFIGURING THE R-828 CHANNEL PRESET FREQUENCIES IN DCS:*



**Fig. 6.10. The R-828 channel preset frequencies**

### **6.1.5. PI-65 (RI-65) audio warning system**

The RI-65 audio warning system is designed to alert the crew of in-flight emergency situations over the intercom system. The audio warning system consists of a control unit which receives input from the onboard sensors and plays back the appropriate advisories and a control panel which allows for testing, repeating an advisory, and shutting off an advisory message. The audio warning unit is installed in the radio compartment on the left side. The control panel is located in the upper center area of the left side console.

The audio warning unit automatically broadcasts the recorded advisory message over the intercom when an activation signal is received from the onboard sensors. The fire warning messages (channels 1 through 4) are also automatically broadcast over the VHF (R-863) radio. If multiple alerts occur simultaneously, audio warnings are broadcast in order of priority.

The following advisories are recorded:

- Aircraft (tail #)... fire in left engine compartment
- Aircraft (tail #)... fire in right engine compartment
- Aircraft (tail #)... fire in transmission compartment
- Aircraft (tail #)... fire in heater compartment
- Dangerous vibration, left engine
- Dangerous vibration, right engine
- Main hydraulic system failure
- Low fuel emergency
- Service cell fuel pump failure, check remaining fuel
- Saddle tank fuel pump failure
- Ice formation warning
- Generator 1 failure
- Generator 2 failure
- Audio warning system operational

RI-65 components:

- message broadcasting equipment
- switch and warning annunciator "ВКЛЮЧИ РИ-65" (TURN ON RI-65) on the left triangular panel, [Fig. 6.11](#)
- control panel, [Fig. 6.12](#)



**Fig. 6.11. Switch and warning annunciator "ВКЛЮЧИ РИ-65" (TURN ON RI-65) on the left triangular panel**

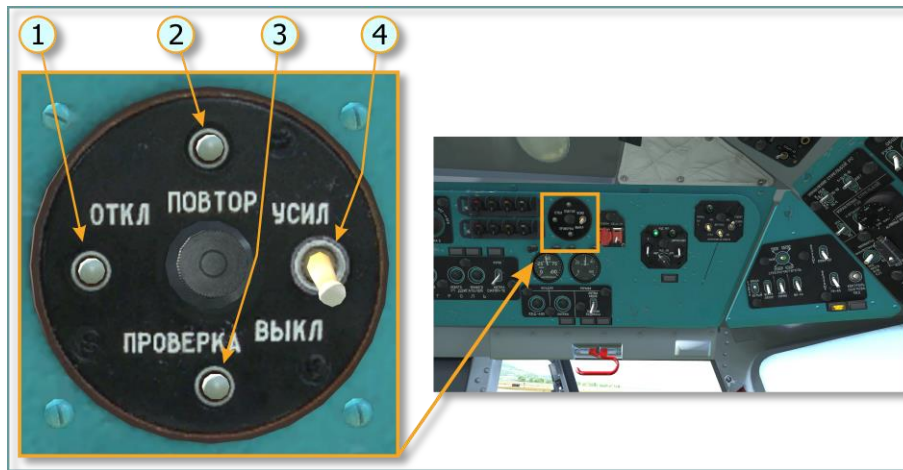

**Fig. 6.12. Control panel of audio warning system RI-65**

1. Button ОТКЛ. (OFF) for turn off listening information and switching R-863 from the transmit mode to the receive mode
2. Button ПОВТОР (REPEAT) for replay the current voice message
3. Button ПРОВЕРКА (TEST) is designed to test equipment operability
4. Switch УСИЛ (GAIN) is not engaged

The warning annunciator is removed when the system is turned on with the "РИ-65" (AUDIO WARN) switch.

The audio warning system receives 27 VDC from the battery bus. The system is engaged using the "РИ-65" (AUDIO WARN) switch located on the left triangular panel.

## 6.2. Radio navigation systems

Radio communication systems installed on the Mi-8MTV2 include:

- АРК-9 (ARK-9) automatic direction finding (ADF) set
- АРК-УД (ARK-UD) VHF homing set
- ДИСС-15 (DISS-15) Doppler navigation set

- PB-5 (RV-5) radar altimeter set

### 6.2.1. APK-9 (ARK-9) automatic direction finding (ADF) set

The ARK-9 ADF set is designed to use non-directional radio beacons (NDB), broadcasting radio stations or compass locators for in-flight navigation. Frequency range of the set is 150 to 1300 kHz. The relative bearing is displayed by needle No. 1 (narrow) on the UGR-4UK directional gyro on the pilot and copilot instrument panels.

The LF-ADF is used for the following situations:

- Flying to or from a radio station or NDB with visual display of the relative bearing.
- Station identification by monitoring the audio call signs.
- Determination and continuous display of the relative bearings to a radio beacon or broadcasting radio station.
- Performing non-precision instrument landing approaches or navigating to the inner and outer ILS marker beacons.

The ADF can be used as a reserve voice communication receiver. Three operating modes are provided: "АHT." (ANT, antenna), "КОМП." (COMP, compass), "ПАМК." (LOOP).

ARK-9 components:

- receiver unit;
- power supply;
- antenna assembly in a common housing along the bottom of the fuselage;



**Fig. 6.13. Loop antenna and nondirectional antenna**

- remote tuner switching unit;
- control panel on the right overhead console;
- "АРК СВ – АРК УКВ" (ADF-MW – ADF USW) switch on the left instrument panel under the UGR-4UK directional gyro to select between ARK-9 and ARK-UD to drive the bearing needle;
- "КОМПАС СВ" (COMPASS MW) circuit breaker on the right circuit breaker panel.

Heading/bearing information is displayed on the UGR-4UK directional gyros on the left and right instrument panels.



**Fig. 6.14. ARK-9 control panel**

1. "ТЛФ-ТЛГ" (VOICE - CW) switch
  2. Signal power indicator
  3. "АРК ВЫКЛ., КОМП., АНТ., ПАМ." (OFF - COMP - ANT - LOOP) mode selector:
    - "ВЫКЛ." (OFF): powers down the ADF set;
    - "КОМП." (COMP, compass): powers up and prepares the set for operation in ADF mode, audio monitoring of the selected frequency and automatic direction finding are functional. Primary operating mode;
    - "АНТ." (ANT, antenna): allows audio monitoring of the selected frequency for tuning or for listening to call letters of signal tones, no direction finding occurs in this mode;
    - "ПАМ." (LOOP): allows audio monitoring of the loop antenna output for direction finding by ear, based on signal fade in and out if the COMPASS mode fails
  4. "Л рамка П" (LOOP) spring-load switch. Initiates manual rotation of the search coil
  5. "ГРОМК." (GAIN) volume control knob
  6. "Б - Д" (B - D CHANNEL) switch to select main ("Д" (D), right) or reserve ("Б" (B), left) channel frequency
- 7-9 FREQUENCY SETTING DIALS:  
 The 100 kHz (7) and 10 kHz (8) discrete frequency dials (switch and drum) set the main (right dial) and reserve (left dial) frequency in the range of 150 kHz - 1290 kHz in 10 kHz steps. The "НАСТР." (TUNE) knobs (9) adjust the set frequency from -10 kHz to +20 kHz;
- "УПРАВЛ." (CONTROL) button. Not utilized

Set to "ТЛФ" (VOICE) to monitor a broadcasting station or demodulate a carrier signal to identify locator beacon call letters. Set to "ТЛГ" (CW) to home on a continuous wave signal. SPU-7 source selector must be set to "PK 1" (ADF) for signal to be heard in headset;

*ARK-9 SPECIFICATIONS:*

Frequency range	150-1300 kHz
Frequency tuning precision	±10 kHz
Frequency separation	10 kHz
Effective homing range to ПАР-10 (PAR-10) type NDB at an altitude of 1000 m	no less than 160 km
Channel switching time	2-4 sec
Signal bearing error	no more than 2°
Time to readiness	1-2 min
Receiver sensitivity in ANT mode	5-8 μV

*ARK-9 OPERATION:*

1. Turn on the ARK-9 LF-ADF set (27V, 115V 400Hz) and the ICS with the "КОМПАС СВ" (COMPASS MW) and "СПУ" (SPU) circuit breakers on the right circuit breaker panel.
2. Set the source selector on the ICS control box to the "PK 1" (ADF1)



position and the "СПУ-РАДИО" (ICS-RADIO) selector to the "РАД" (RADIO, down) position.

3. Set the selector knob for the UGR-4UK needle No.1 to the "APK-CB" (ADF-MW)



position for visual bearing needle control by the ARK-9 LF-ADF system.

4. On the ARK-9 control panel ([Fig. 6.14](#)):
  - o mode selector to "АHT" (ANT) (3);



- "ТЛФ - ТЛГ" (VOICE - CW) switch to "ТЛГ" (CW). A signal should be heard in the headset and disappear when the switch is set to "ТЛФ" (VOICE) (1);
- "ГРОМК." (GAIN) volume control to maximum (5);
- "Б - Д" (B - D CHANNEL) switch to "Б" (B, reserve channel) (6);
- dial the frequency of the desired beacon using the left frequency setting dial and confirm the beacon call letters (Morse ID) (7-9)
- mode selector to "КОМП." (COMP) (3). The No.1 bearing indicator on the UGR-4UK directional gyro should display the bearing to the selected beacon transmitter
- press the "Л-ПАМКА-П" (LOOP) switch (4) to turn the No.1 arrow on the directional gyro 150° - 170° off the beacon bearing. Upon releasing the switch, confirm the No.1 arrow returns to the correct beacon bearing.

5. Set the "Б - Д" (B - D CHANNEL) switch ([Fig. 6.14](#), 6) to "Д" (D, main channel) and tune the main channel following the same process as the reserve channel.

In case radio interference hampers operation of the ADF, use the "Л-ПАМКА-П" ([Fig. 6.14](#), 4) (LOOP) mode to determine bearing to the transmitter based on fading signal volume ([Fig. 6.14](#), 2).

### 6.2.2. АРК-УД (ARK-UD) VHF homing set

The ARK-UD VHF homing set is designed primarily for search and rescue of downed aircraft and aircrews. The system will home on radio stations (beacons), such as P-855YM (R-855UM) portable emergency radio, emitting CW or pulse signals over one of six VHF or one UHF preset frequencies. The secondary purpose of the system is to direct aircraft to airfields using VHF ground stations and assist in joining aircraft in flight.

The ARK-UD provides:

- homing on VHF and UHF beacons for search and rescue helicopters
- Indication of the moment a homing beacon is flown over by a reversal of the bearing indicator on the directional gyro.
- audio identification of a homing beacon by the pilot

*ARK-UD COMPONENTS:*

- loop antenna installed on the bottom of the center fuselage



**Fig. 6.15. ARK-UD loop antenna housing**

- antenna amplifier
- control panel located on the right overhead console
- direction-finding receiver
- АШС-УД (AShS-UD) blade antenna on the tail boom



**Fig. 6.16. AShS-UD blade antenna**

- "БЛОКИРОВКА АРК-УД" (VHF-ADF INTERLOCK) switch on the right triangular panel used to prevent interference with the R-863 radio
- "РАДИОКОМПАС УКВ" (ARK-UD) circuit breaker on the right circuit breaker console
- "АРК СВ - АРК УКВ" (ARK-MW - ARK-USW) switch on the left instrument panel to select between ARK-9 and ARK-UD bearing source for the directional gyro indicator.

Operation in VHF and UHF bands is less accurate than MW due to:

1. VHF and UHF wavelengths affected by fuselage elements of equal size causing directional error in the bearings displayed by the directional gyro. In this case the ARK-UD provides only a general direction to the beacon.
2. VHF wavelengths being reflected by fuselage elements causing the bearing indicator to oscillate as the helicopter approaches the homing beacon.

*ARK-UD SPECIFICATIONS:*

VHF frequency range	114.166-124.1 MHz
VHF preset frequencies	114.166 МГц; 121.5 MHz 114.333 МГц; 123.1 MHz 114.583 МГц; 124.1 MHz
UHF frequency range	243-248 MHz
UHF preset frequency	243 MHz
Effective range to R-855UM type beacon at altitudes:	
3000 m	55 km
1000 m	35 km
500 m	25 km
300 m	15 km
Bearing error	no more than $\pm 3$
Beacon location error at altitude of 1000 m	no more than $\pm 200$ m



**Fig. 6.17. ARK-UD control panel**

1. "ВЫКЛ., УП., ШП, И, РПК." (OFF - NARROW BAND - WIDE BAND - PULSE - RPK) MODE selector:

- "ВЫКЛ." (OFF): ARK-UD system is switched off
- "УП" (NARROW BAND): CW narrow band reception, illuminates corresponding lamp
- "ШП" (WIDE BAND): CW wide band reception, illuminates corresponding lamp

3. "КАНАЛЫ" (CHANNEL) selector: sets preset VHF frequency

4. "Л -АНТ.- П." (ANTENNA L/R) buttons: pressed to manually rotate loop antenna left or right

5. "КОНТР." (TEST) button: self-test mode operation

6. Volume control knob

7. "УКВ-ДЦВ" (FQ BAND) switch: sets VHF (up) or UHF (down) operating band. When set to VHF, use channel selector to tune receiver to the desired frequency channel. When set to UHF,

- "И" (PULSE): the homing channel transduces 40  $\mu$ s pulse signals sent at 300 Hz while the audio output channel operates over the wideband component of the receiver. Operation in PULSE mode illuminates the corresponding
  - "РПК" (RPK): not utilized
2. "ЧУВСТВ. Б-М" (SENSITIVITY HIGH - LOW) switch: sets antenna sensitivity for the homing channel

receiver tunes to 243.000 MHz

The ARK-UD operates on the following preset frequencies:

Band	Frequency, MHz	Channel #
VHF	114.166	1
VHF	114.333	2
VHF	114.583	3
VHF	121.5	4
VHF	123.1	5
VHF	124.1	6
UHF	243.0	any

In TEST mode, the bearing needle of the UGR-4UK directional gyro points to  $180^{\circ} \pm 10^{\circ}$  and the currently set operating mode lamp illuminates.

Heading/bearing information is displayed on the UGR-4UK directional gyros on the left (only) instrument panels.

*ARK-UD OPERATION:*

1. Turn on the ARK-UD ADF set (27V, 115V 400Hz) and the ICS with the "РАДИОКОМПАС УКВ" (ARK-UD) and "СПУ" (SPU) circuit breakers on the right circuit breaker panel. Set the source selector on the ICS control box to the "PK 2" (SAR) position (only required for audio signal monitoring; not required for radio compass operation) and the "СПУ-РАДИО" (ICS-RADIO) selector to the RADIO



(down) position

2. Set the selector knob for the UGR-4UK needle No.1 to the "APK-УКВ" (ADF-USW)



position for bearing needle control by the ARK-UD system.

3. On the ARK-UD control panel (Fig. 6.17):

- MODE selector (1) set to "УП" (NARROW BAND). When the "ШП" (WIDE BAND) lamp illuminates as the helicopter nears the beacon, switch to ШП (WIDE BAND) mode
- FQ BAND switch (7) and CHANNEL selector (3) set to correspond to required band and channel for reception of desired signal. *If operating in UHF mode, channel setting is irrelevant.*

4. Ready.

In PUSLE mode, a tone signal with a reduced frequency is heard in the headset (not currently implemented in DCS).

The ARK-UD set can be utilized in conjunction with the R-828 radio set allowing for homing on frequencies outside the normal ARK-UD presets. Selection of R-828 antenna is made by setting the "P-828 СВЯЗЬ – КОМПАС" (R-828 VOICE-HOMING) mode switch on the right auxiliary panel to "КОМПАС" (COMASS)



For more information, see the [R-828](#) section of the manual.

**ARK-UD operation in DCS:**

*Utilizing the ARK-UD set in DCS requires that a transmitter is created and added to the world by placement on the map or attached to an airborne or ground unit. The transmitter must be configured to transmit over the correct frequency and modulation setting compatible with the ARK-UD set. See the DCS User Manual for more information on unit placement and configuration in DCS World.*



### 6.2.3. ДИСС-15 (DISS-15) doppler navigation set

The DISS-15 Doppler system, operating in conjunction with the AGB-3K gyro-horizon and the GMK-1A gyro-compass system, is designed for continuous automatic measurement and display of the ground speed components in the low speed (hover) mode; ground speed and drift angle in the navigation mode; computation and indication of the helicopter positional coordinates; and for delivery of these data to other onboard systems.

The Doppler system, in conjunction with other onboard instruments (i.e., autopilot, radar altimeter, etc.) assists the pilot in solving the following navigational and flight problems:

- navigation to waypoint coordinates;
- precision approaches;
- hovering and landing when current wind information is not available;
- hovering and controlling helicopter movement in poor visibility or IMC.

#### *DISS-15 COMPONENTS:*

- low frequency unit (inside of tailboom);
- coordinate computer (inside of tailboom);
- high frequency unit (underside of the tail boom)

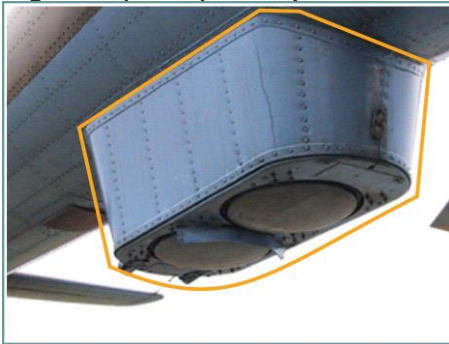

- stationary flight indicator located on the pilot's (left) instrument panel



- ground speed and drift angle indicator on the copilot (right) instrument panel



panel

- digital display unit located on the copilot instrument panel



- "ДИСС ОТКАЗАЛ" (DISS FAILURE) light on the copilot instrument panel (illuminates when the system is in MEMORY mode or in case of failure)



- control panel on the right rack in the cockpit (behind the copilot)



- "ДИСС" (DOPPLER) circuit breaker on the right circuit breaker console and



DISS switch

The Doppler transceiver/antenna unit is located at the bottom of the tail boom. It generates, transmits, and receives microwave energy. It sends the energy it receives to the low frequency signal converter unit for conversion into DC signals that are proportional to the lateral, longitudinal, and vertical components of ground speed. The unit is equipped with a fan for air cooling.

Ground speed data is supplied to the following indicators:

- low speed (hover) indicator;
- ground speed and drift angle indicator;
- digital display unit.

When flying over water with a sea state of greater than 1 - 2, the Doppler system switches to MEMORY mode. Previously measured readings are displayed on the indicators. The system also switches to MEMORY mode at roll angles of greater than 30° and pitch angles of greater than 7°.

*DISS-15 SPECIFICATIONS:*

Emission type	continuous
Emission frequency	13325 + 20 - 30 MHz
Emission power output	no less than 2 W
Altitude limits	10-3000 m
Altitude limits in hover mode:	
over land surface	2-1000 m
over water surface (sea state greater than 1)	2-500 m
Measured ground speed range	0-400 km/h
Measured drift angle range	±45°
Measurement error:	
ground speed	0.5% ± 1, 5 km/h
drift angle	25 minutes
coordinates	1% ± 1 km/h
Longitudinal and lateral components calculation error	± 1.5 km/h
Vertical component calculation error	± 0.4 m/s

*DISS-15 DOPPLER SYSTEM CONTROLS AND INDICATORS:*

*DOPPLER CONTROL PANEL:* used to select the operating mode of the system and to introduce three test functions. Additionally, the following failures are continually monitored and reported by the system:

- the ground speed and drift angle indicator "П" (P) warning light illuminates whenever the radio signal ground return is too weak or absent

- the Doppler control panel "M" (M) warning light illuminates in case of Doppler system magnetron failure
- the Doppler control panel "B" (V) warning light illuminates in case of Doppler computer failure

The "ДИСС ОТКАЗАЛ" (DISS FAILURE) annunciator on the copilot instrument panel illuminates whenever either the "M" (M) or "B" (V) light illuminates on the Doppler control panel.



**Fig. 6.18. Doppler control panel**

- |   |  |
|---|--|
| <p>1. MODE selector: positions 1-4 perform test functions and do not initiate radio emissions. Position 5, "РАБОТА" (OPERATE) is the normal functional mode and initiates radio emissions and measurement of ground speed and drift angle components;</p> <p>2. "РАБОТА" (OPERATE) light: indicates the system is operating normally;</p> | <p>3. "В" (V) light: illuminates if the Doppler computer fails;</p> <p>4. "КОНТРОЛЬ" (TEST) light: indicates the system is in test mode;</p> <p>5. "М" (M) light: illuminates in the event of magnetron failure.</p> |
|---|--|

*STATIONARY FLIGHT INDICATOR:* continuously displays the vertical, lateral, and longitudinal components of helicopter ground speed during hover and low speed flight.

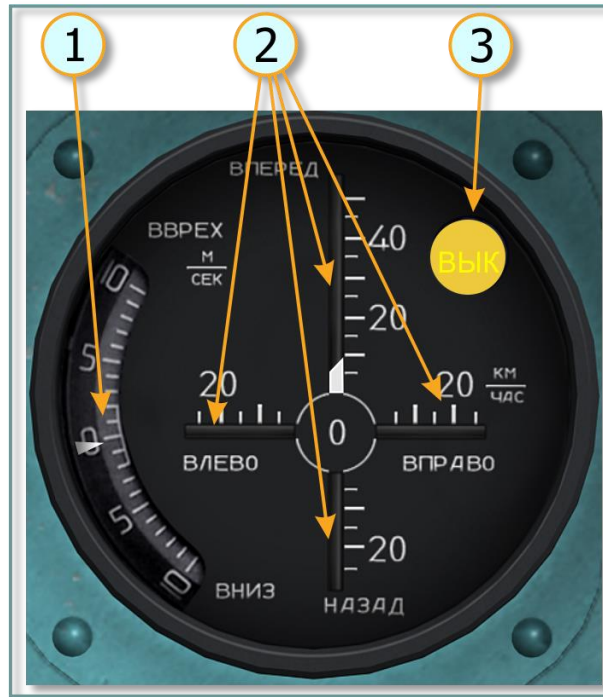
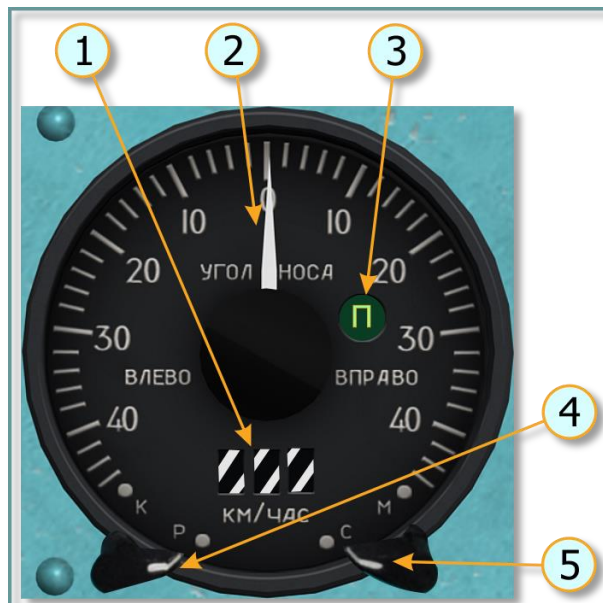

**Fig. 6.19. Stationary flight indicator**

1. Vertical pointer: displays vertical speed within a range of  $\pm 10$  m/s on a scale graduated to 1 m/s;  
 2. Lateral and longitudinal indexes: display the lateral speed within a range of 25 km/h, forward speed up to 50 km/h and rearward speed up to 25 km/h. Scales graduated to 5 km/h;

3. "ВЫК." (OFF) light: illuminates whenever: forward speed passes 50 km/h (stationary flight indicator disengages, ground speed and drift angle indicator engages); the Doppler system is in MEMORY mode;

*GROUND SPEED AND DRIFT ANGLE INDICATOR:* displays the ground speed and drift angles when the helicopter is traveling at speeds in excess of 50 KPH.

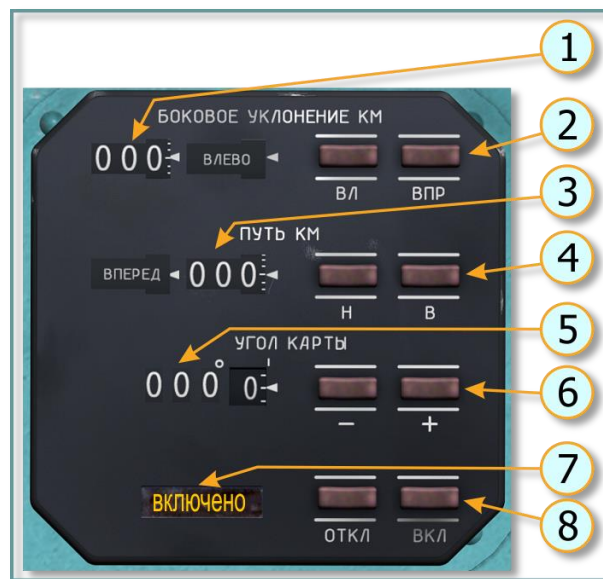

**Fig. 6.20. Ground speed and drift indicator**



1. Ground speed window: displays ground speed in kilometers per hour (KPH) within a range of 50 - 400 KPH. At speed below 50 KPH, the window is blanked out;
2. Drift indicator needle: indicates the drift angle, to the right or left, in degrees within a range of  $\pm 45^\circ$  on a scale graduated to  $2^\circ$ ;
3. "П" (P) light: illuminates when the Doppler system is operating in MEMORY mode;
4. "P-K" (TEST - OPERATE) knob: selects either test or normal indicator operation mode. In TEST mode, the indicator shows  $306 \pm 3.5$  KPH and  $15 \pm 1^\circ$  of drift;
5. "C-M" (LAND - SEA) knob: used to select the characteristics of the surface the helicopter is traveling over;

**DIGITAL DISPLAY UNIT:** displays the distance the helicopter has flown from the starting point and the lateral distance to the left or right of the course that the pilot enters on the "УГОЛ КАРТЫ" (COURSE ANGLE) counter. The readout information is provided by the Doppler computer.



**Fig. 6.21. Digital display unit**

1. "БОКОВОЕ УКЛОНЕНИЕ КМ" (LATERAL DEVIATION) counter: drum-type counter with four wheels, right window displays direction of deviation from course ("ВЛЕВО" (LEFT) or "ВПРАВО" (RIGHT)); numerical counter displays the amount of lateral deviation in kilometers in 200 m steps;
2. "ВЛ" (LEFT), "ВПР" (RIGHT) buttons: used to reset the LATERAL DEVIATION counter;
3. "ПУТЬ КМ" (DISTANCE) counter: drum-type counter with four wheels, displays the distance the helicopter has flown from the starting point. The left window displays the relative direction, "ВПЕРЕД" (FORWARD) or "НАЗАД" (AFT) of the starting point; numerical counters display the distance traveled in kilometers in 200 m steps;
4. "H" (AFT), "B" (FWD) buttons: used to reset the DISTANCE counter;
5. "УГОЛ КАРТЫ" (COURSE ANGLE) counter: drum-type counter with four wheels, displays the desired course in degrees (first three digits) and minutes (last two digits) in 6 minute steps;
6. "-" and "+" buttons: used to set the counters to the desired course; counter does not rollover between 0 and 360 degrees;
7. "ВКЛЮЧЕНО" (ON) light: indicates operation of the unit;
8. "ВКЛ" (ON) and "ОТКЛ" (OFF) buttons: engage/disengage digital readout.

**DISS-15 OPERATION:**

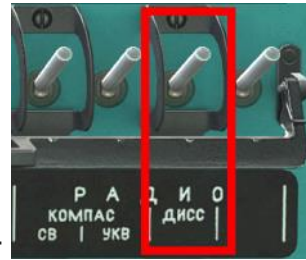

1. Close the DOPPLER (ДИСС) circuit breaker

After powering the circuits 27V and 115V 400Hz is necessary functionally check the ДИСС-15 Doppler system proceeding as follows:

2. Set the selector switch on the Doppler monitor panel (behind of the co-pilot) to



MEMORY (ПАМЯТЬ)

3. Set the LAND-SEA ("C-M") and OPERATION-MONITORING ("K-P") selector



switches to LAND ("C") and OPERATION ("P"), respectively



4. Set the DOPP (ДИСС) switch and, if necessary,



the DOPPLER LIGHT (ПОДСВЕТ ДИСС) switch to ON (ВКЛ). The TEST (КОНТР), "M" and "B" annunciators on the monitor panel and the "П" annunciator on the ground speed and drift angle indicator, and the DOPP FAIL (ДИСС ОТКАЗАЛ) annunciator on the RH instrument panel should come on.

5. Test the Doppler system for solving the test problems by successively setting the selector switch on the Doppler monitor panel to 1, 2 and 3. The readings of the hovering and low speed indicator should not differ by more than  $\pm 2.5$  km/h and  $\pm 0.5$  m/s respectively, from the values indicated on the monitor panel, and the readings of the ground speed and drift angle indicator should be  $136 \pm 3.5$  km/h and  $0 \pm 1^\circ$ , respectively.

6. Test the Doppler system in the SEA (МОРЕ) mode by setting the "C-M" (land-sea) selector switch on the ground speed and drift angle indicator to "M"



with the monitor panel selector switch set to SPEED – 136 (СКОРОСТЬ – 136), DRIFT – 0 (СНОС – 0). The ground speed should rise by 3 km/h. Leave the "C–M" selector switch either in "C" or "M" position depending on the type of an anticipated flight – overterrain or over sea.

7. Test the coordinate indicator, for which purpose set the TRACK-KM (ПУТЬ KM), ХТК DISTANCE-KM (БОКОВОЕ УКЛОНЕНИЕ-KM), GRIVATION (УГОЛ КАРТЫ) digital readouts to zero by operating the "H" (backward), "B" (forward), "ВЛ" (to left), "ВПР" (to right), "-" and "+" keys. With the Doppler monitor panel selector switch set to SPEED-136 (СКОРОСТЬ – 136), DRIFT – 0 (СНОС – 0), a ground speed reading of  $136 \pm 3.5$  km/h and a drift angle reading of  $0 \pm 1^\circ$ , depress the ON (ВКЛ) key on the coordinate indicator. With the Doppler system operating properly, the FORWARD (ВПЕРЕД) digital readout of the coordinate indicator should display 11.3 km in 5 min and ХТК DISTANCE-KM – 0.

8. Check the computer for correct processing of the test problem introduced from the ground speed and drift angle indicator by setting the "K–P" selector switch to "K"



The ground speed reading should be  $306 \pm 3.5$  km/h, and the drift angle reading should be to left  $15 \pm 1^\circ$ .

Check the doppler system for selection of the MEMORY mode by setting the monitor panel selector switch to MEMORY (ПАМЯТЬ), and the ground speed reading should change by not more than  $\pm 9$  km/h and the drift angle reading by not more than  $\pm 3^\circ$ . The "П" annunciator on the ground speed and drift angle indicator should come on simultaneously.

9. After completion of the above checks set the "K-P" selector switch to "P" and the



monitor panel selector switch to OPERAT (РАБОТА)

10. For using Digital display unit it necessary to set УГОЛ КАРТЫ (ROUTE (magnetic) angle direction) as magnetic heading at map is required. Then the push "ВКЛ" (ON) button for engage digital readout in begin route.

### 6.2.4. PB-5 (RV-5) radar altimeter set

The radar altimeter set continuously indicates absolute altitude. The system is a "look down" device which accurately measures the distance between the aircraft and the highest terrain from 0 to 750 meters. The system accuracy is  $\pm 2$  m at altitudes up to 20 m and  $\pm 0.1 \times N$  (where N equals altitude) at altitudes above 20 m.

RV-5 components:

The RV-5 radar altimeter set includes the following components:

- transceiver
- altimeter indicator on the pilot's (left) instrument panel
- receiving and transmitting antennas installed on the bottom of the tail boom
- "РАДИОВЫСОТОМЕР" (RV-5) circuit breaker on the right circuit breaker console
- "РАДИОВЫСОТОМЕР ВКЛ. - ОТКЛ." (RADAR ALTIMETER) power switch on the left instrument panel

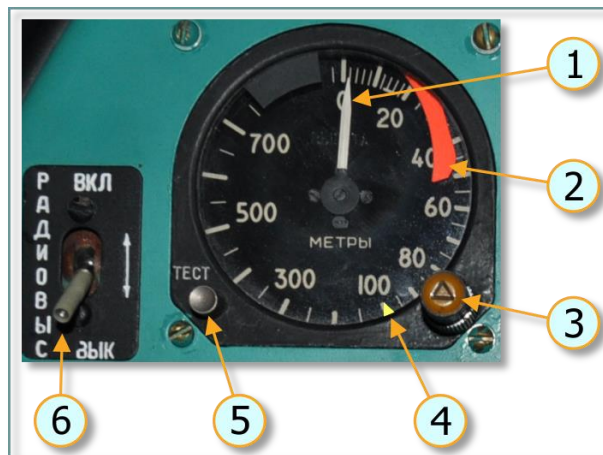

**Fig. 6.22. Radar altimeter indicator**

- |  |   |
|--|---|
| <ol style="list-style-type: none"> <li>1. Altimeter pointer</li> <li>2. Altimeter fail flag</li> <li>3. SET ALTITUDE knob used to adjust ground-proximity warning setting. The SET ALTITUDE knob incorporates a yellow LOW ALT caution light which illuminates when the helicopter descends below preset altitude</li> </ol> | <ol style="list-style-type: none"> <li>4. low altitude pointer shows low altitude setting</li> <li>5. "ТЕСТ" (TEST) button to test the altimeter</li> <li>6. "РАДИОВЫСОТОМЕР ВКЛ. - ОТКЛ." (RADAR ALTIMETER) power switch.</li> </ol> |
|--|---|

The radar altimeter does not require additional adjustment or tuning for in-flight use (except setting of ground proximity warning altitude).

Reliance on the radar altimeter is not recommended whenever:

- flying in mountainous terrain where absolute altitude variations may exceed the altimeter's limitations
- roll or pitch angle exceeds  $40^\circ$

At roll angles greater than 20° the reading accuracy diminishes due to slant range effects.

If helicopter altitude exceeds the altimeter's limitations or in case of failure, the red fail flag appears along the scale on the right side of the indicator.

The LOW ALT caution light illuminates and an audio warning tone is heard when the helicopter descends to the set ground proximity warning altitude.

The radar altimeter may indicate an erroneous reading if large sized cargo is transported on external sling.

Switching off power to the radar altimeter will raise the power/failure warning flag on the indicator and may leave the pointer indicating along the altitude scale.

The radar altimeter is powered with 27 VDC and 115 VAC 400 Hz.

*RV-5 SPECIFICATIONS:*

Frequency range	4200-4400 MHz
Altitude range	0-750 m
Modulation type	frequency
Audio warning duration	3-9 sec
Accuracy:	
altitude: 0-20 m	±2 m
altitude:20-750 m	± 0.1 x N (N = altitude)

*RV-5 OPERATION:*

1. Turn on the "РАДИОВЫСОТОМЕР" (RV-5) circuit breaker on the right CB

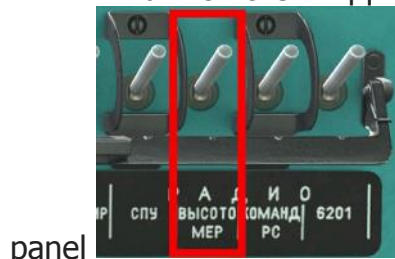

panel

2. Set the "РАДИОВЫС. ВКЛ.– ВЫК." (RADAR ALTIMETER) switch on the left

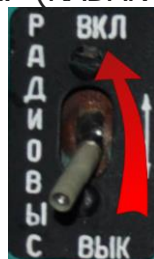

instrument panel to the ON (UP) position

3. When turned on, the radar altimeter performs a self-test indicated by the pointer turning to the blanked area at the top of the scale and returning to the double-graduated area at the start of the scale within 1-2 min. When complete, the test should result in the warning flag disappearing.

4. If the ground proximity warning altitude is set to at least 5 meters, descent past the warning altitude setting will trigger a 3 - 9 second audio warning tone and illuminate the LOW ALT caution light.



5. Press the "TECT" (TEST) button to test the indicator. Pressing the "TECT" (TEST) button should turn the arrow around the scale to the banked out area at the top.

6. Release the "TECT" (TEST) button to allow the arrow to return to its starting position.

### 6.2.5. Special purpose radio systems (UV-26 EW countermeasures system)

The UV-26 EW countermeasures system (Flare Dispenser) are used as decoys against heat-seeking missiles like the Iгла (SA-16), FIM-92 Stinger, AIM-9 Sidewinder, R-60 (AA-8 Aphid), and R-73 (AA-11 Archer), etc.

#### Components

The UV-26 countermeasures system includes:

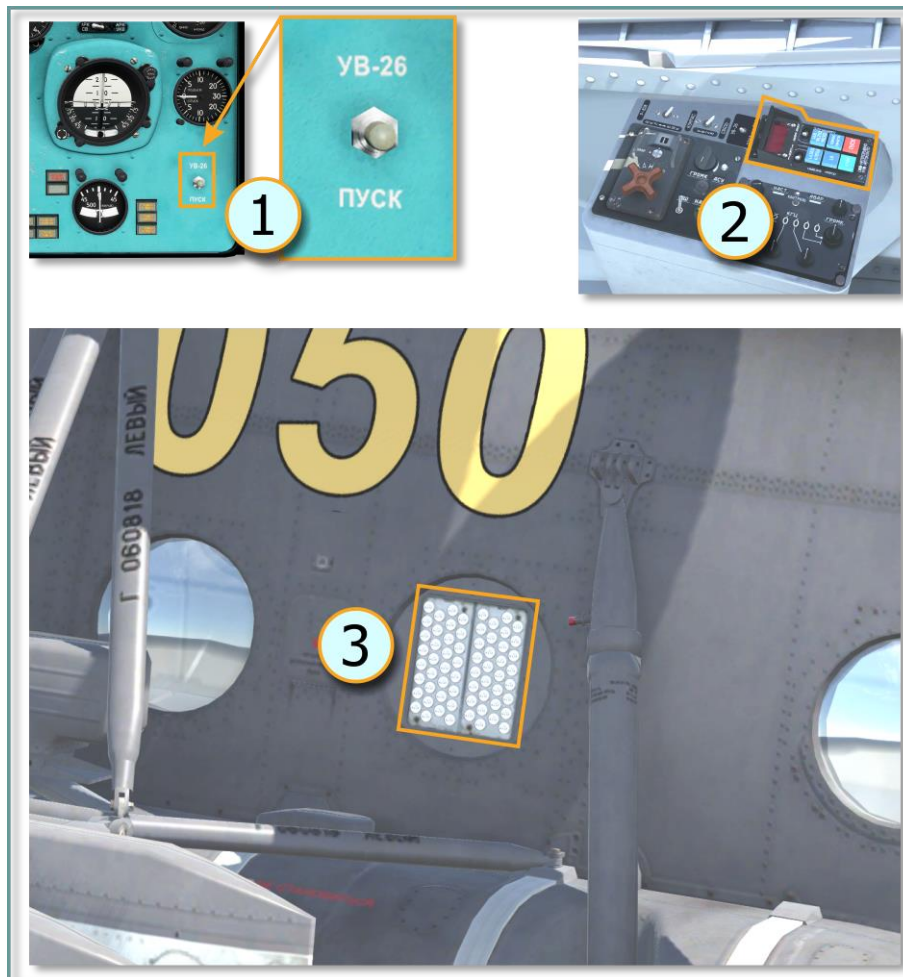

Fig. 6.23. The UV-26 elements

- (1) button for release flare on the Left Instrument Panel;
- (2) UV-26 control panel, at Right Auxiliary Panel;
- (3) four mounts (2x2) with Flares (at Left and Right side of fuselage). A total of 4 mounts – 128 PPI-26 flare cartridges.

### УВ-26 (UV-26) control panel

The UV-26 countermeasures control panel is located to the right of the overhead panel and it is used to configure the release of infrared (IR) flare countermeasures.



Fig. 6.24. UV-26 control panel:

1. **Program display.** The digital read-out indicates the currently selected flare dispensing parameters. When the "НАЛИЧ-ПРОГР" (REMAIN-PROGRAM) switch is in the "НАЛИЧ" (REMAIN) position, the display shows the remaining quantity of flares (the Mi-8 can carry a maximum of 128). When in the "ПРОГР" (PROGRAM) position, the first number indicates the "СЕРИЯ" (SEQUENCES) setting, the second number indicates "ЗАЛП" (SALVO) setting, and the third number shows the setting for "ИНТЕРВАЛ" (INTERVAL).
2. **Dispenser side lamp** – Indication that flares will be dispensed from the left dispenser.
3. **"БОРТ"** (LFT-RGT, left/right) release select switch. This is a three position switch that can be set to the center position for release of flares from both sides; to the left for release of flares from the left side or to the right for release of flares just from the right side. Depending on the selection, the appropriate lamp(s) will be visible in the display field above. **[RAlt + ]**.
4. **"СЕРИЯ"** (SEQUENCUES) button **[RShift + Insert]**. Pressing this button cycles through the number of flare sequences options. The number of sequences is equal to the number of times the program will be run (except for 5 when the number of sequences is 12 and for 7 when the number of sequences is 15). When the value is set to 0, flares will be dispensed continuously.
5. **"ЗАЛП"** (SALVO) button **[RCtrl + Insert]**. Press this button to cycle between the number of flares to be released in a single program sequence. Values range 1 through
6. **"СТОП"** (STOP) button **[Delete]**. Stops the currently running program.
7. **Dispenser side lamp** – Indication that flares will be dispensed from the right dispenser.
8. **"НАЛИЧИЕ – ПРОГР"** (REMAIN - PROGRAM) switch **[RCTRL+ ]**. When set to "НАЛИЧИЕ" (REMAIN), the display indicates the number of flares remaining; when set to "ПРОГР" (PROGRAM), it shows the current flare program numeric code.
9. **"ИНТЕРВАЛ"** (INTERVAL) button **[RAlt + Insert]**. Pressing this button cycles between the time-delay between flare release settings. The delay is in seconds and is equal to the displayed number except for the cases of 7, 9 and 0, for which the intervals are 0.25, 0.5 and 0.125 seconds respectively.

10. "СБРОС ПРОГР" (RESET) button **[RCtrl + Delete]**. This button resets the programmed parameters to the default, "110".

11. "ПУСК" (DISPENSE) button **[Insert]**. Pressing this button executes the configured flare dispersion program.

Example programs:

**110:** 1 sequence, dispense 1 flare, delay of 0.125s. Pressing "ПУСК" releases a single flare from the selected side container (depending on the position of the "БОПТ" (SIDE) switch). This is the default program.

**622:** 6 sequences, 2 flares in a sequence, 2 second interval. Flares will be dispensed in pairs, one from each side or from one side only, again depending on the "БОПТ" (SIDE) switch position.

**529:** 12 sequences, 2 flares in a sequence, interval of 0.5 s between releases.





**7**

***SYSTEMS OF HELICOPTER***

## 7. SYSTEMS OF HELICOPTER

### 7.1. Electrical Power Supply System

The helicopter power supply systems include primary and secondary power sources as well as ground power sources, [Fig. 7.1.](#)

#### 7.1.1. Primary Power Sources

The primary power source is AC electrical power system. This system includes two 3-phase 208 VAC 400 Hz CGC-40ПУ (SGS- 40PU) generators. The primary power source is rated at 80 kVA.

The No. 1 generator supplies power to:

- The No.1 BY-6A (VU-6A) rectifier
- A TC310C04Б (TS310S04B) (208/36) power transformer
- The main and tail rotor deice system.

The No. 2 generator supplies power to:

- The No. 2 and No. 3 BY-6A (VU-6A) rectifiers
- A TC/1-2 (TS/1-2) (208/115) power transformer
- The windshield deice system and the air inlet Particle Separator System (PSS).

If one of the generators fails, power can be supplied to all systems, except the main and tail rotor deice system, by switching the secondary power supply sources (TC310C04Б (TS310S04B) and TC/1-2 (TS/1-2) transformers) to the channel of the operational generator. Therewith, the No. 3 rectifier serves as a backup and, in event of the No.1 generator fails, it connects to the No.1 generator channel. So that, if one of the generators fails, two generators always operate.

If both generators fail, the components and systems required to safely complete the flight are powered by the emergency power sources.



### Power Supply and Distribution Equipment

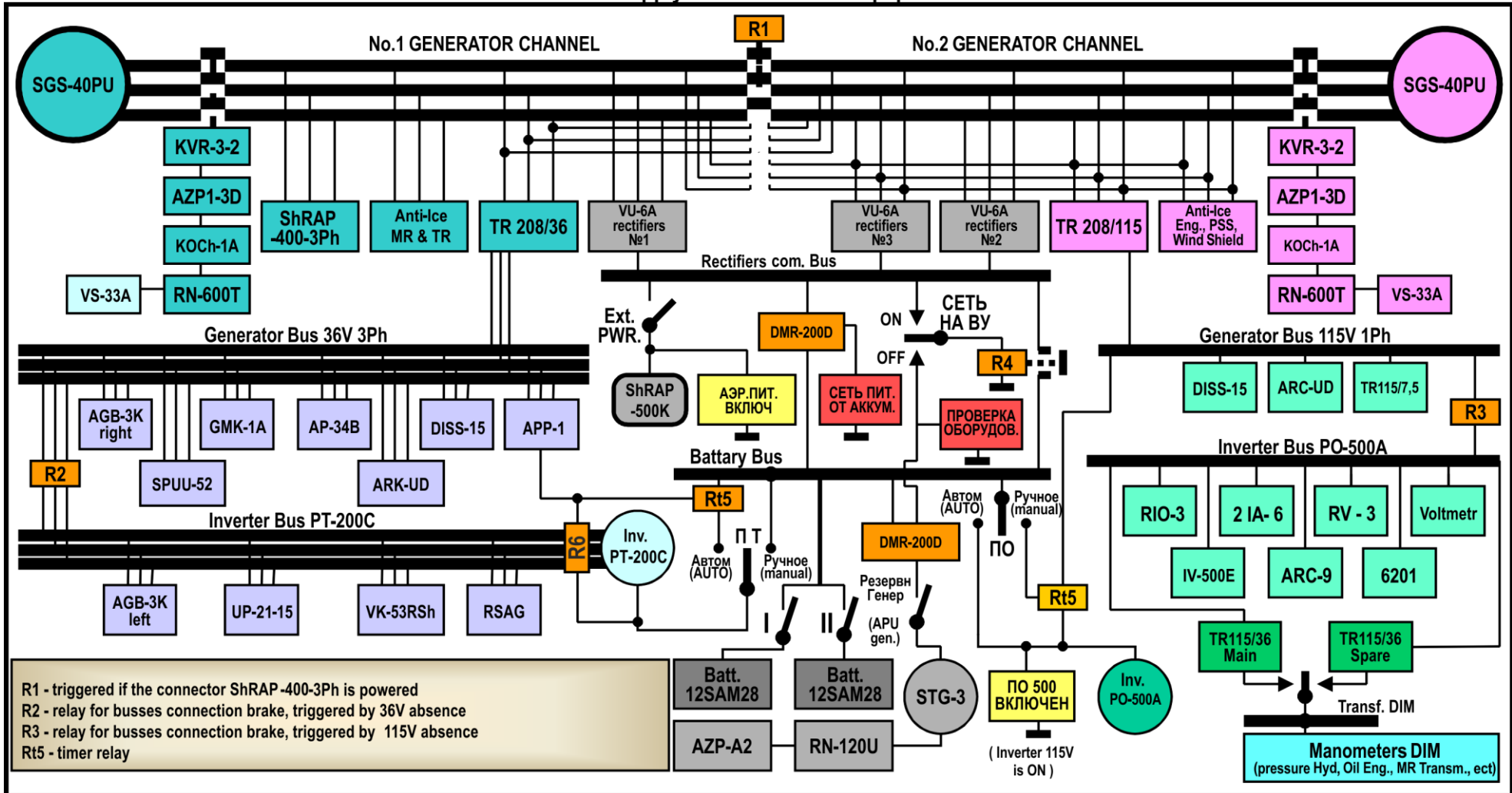

Fig. 7.1. Electrical Power System Scheme

### 7.1.2. Secondary Power Sources

The helicopter electrical components are supplied AC and DC power by the following single-channel power sources:

- A Single-Phase 115 VAC 400 Hz System
- A Single-Phase 36 VAC 400 Hz System
- A 3-Phase 36 VAC 400 Hz System
- A 27 VDC System
- An Emergency Power Sources.

#### ***Single-Phase 115 VAC System***

The single-phase 115 VAC 400 Hz system is powered by the No. 2 generator channel through the TC/1-2 (TS/1-2) power transformer. The transformer is rated at 2 kVA. During normal operation, it supplies power to all installed components that require 115 VAC 400 Hz singlephase power. If the No. 2 generator fails, the TC/1-2 (TS/1-2) transformer is switched by a relay to receive power from the No. 1 generator channel.

If both generators or the TC/1-2 (TS/1-2) transformer fails, the 115 VAC components and systems required for safe completion of the flight are powered by the ПО-500А (PO-500A) backup inverter.

#### ***Single-Phase 36 VAC System***

The single-phase 36 VAC 400 Hz system is powered by the single-phase 115 VAC 400 Hz Inverter Bus via the main and TP 115/36 (TR115/36) standby power transformers. The TP 115/36 (TR115/36) power transformer supplies power to the engine and drive system monitoring instruments.

#### **3-Phase 36 VAC System**

The 3-phase 36 VAC 400 Hz system is powered by the No. 1 generator channel through the TC310C04Б (TS310S04B) transformer. The transformer is rated at 1 kVA. During normal operation, the transformer provides power to all 3-phase 36 VAC components and systems. If the No. 1 generator fails, the TC310C04Б (TS310S04B) transformer is automatically switched to receive power from the No. 2 generator channel.

If both generators or the TC310C04Б (TS310S04B) transformer fails, the 3-phase 36 VAC components and systems required for safe completion of the flight are powered by the ПТ-200Ц (PT-200Ts) inverter.

#### ***27 VDC System***

The 27 VDC system is powered by the AC generators through three BY-6A (VU-6A) rectifiers, each rated at 6 kW. All three rectifiers are connected in parallel to a common bus. The Rectifier Bus is linked to the Battery Bus through a ДМР-200Д (DMR-200D) reverse current relay.

All 27 VDC components and systems can be powered by two of the rectifiers. The No. 3 BY-6A (VU-6A) rectifier is connected to the No. 2 rectifier channel and serves as a backup. If the No. 2 generator fails, the No. 3 rectifier switches automatically to the No. 1 generator channel and along with the No. 1 BY-6A (VU-6A) rectifier powers all 27 VDC components.

If both generators fail, or if there is a fault in the rectifier circuits, the flight essential 27 VDC components are powered by the emergency power sources, as two 12CAM-28 (12SAM-28) batteries and the AI-9B (AI-9V) engine CTF-3 (STG-3) starter-generator.

*THE HELICOPTER EMERGENCY POWER SOURCES* include:

- two 12CAM-28 (12SAM-28) batteries
- the ПO-500A (PO-500A) inverter
- the ПТ-200Ц (PT-200Ts) inverter
- the AI-9B (AI-9V) engine CTF-3 (STG-3) starter-generator.

Two batteries and the ПO-500A (PO-500A) and ПТ-200Ц (PT-200Ts) inverters serve for safe completion of the helicopter flight. Emergency completion of the flight is possible only when the batteries and the AI-9B (AI-9V) engine CTF-3 (STG-3) starter-generator operate simultaneously. For this purpose, the starter-generator should operate in a generator mode in 30 min.

Therewith, the AI-9B (AI-9V) engine CTF-3 (STG-3) starter-generator and ПO-500A (PO-500A) and ПТ-200Ц (PT-200Ts) inverters can also be used for checking aircraft systems on the ground under field conditions. The starter-generator is rated at 3 kW. If it is used for ground testing, the DC components and systems must be checked one at a time to prevent overloading.

### 7.1.3. Electrical Power Supply System Control

Electrical Power Supply System is controlled by the right side console in the cockpit, [Fig. 7.2](#).

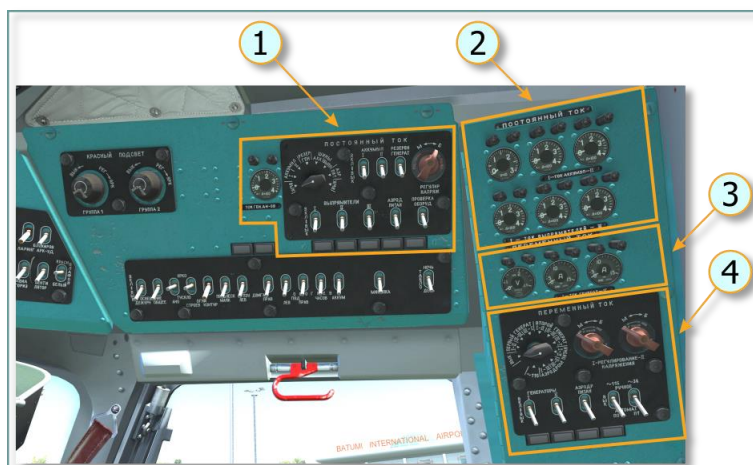
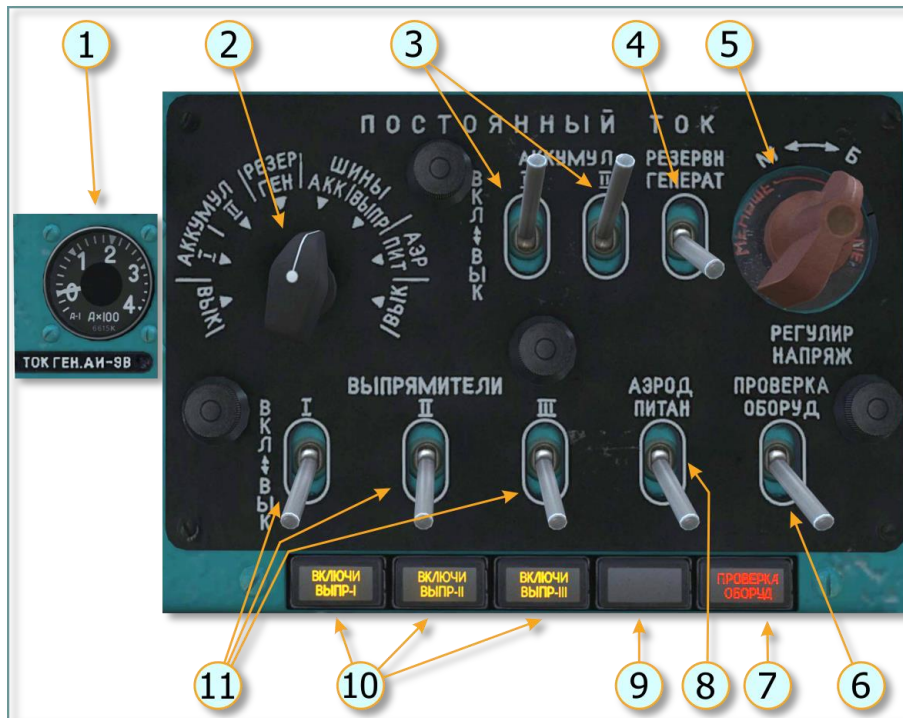

**Fig. 7.2. Location of the controls of electrical power supply system**

- |                                      |                                      |
|--------------------------------------|--------------------------------------|
| 1. DC Power Panel                    | 3. AC system controls and indicators |
| 2. DC system controls and indicators | 4. AC Power Panel                    |

## DC Power Control

DC power control (energizing, voltage control, load control) is exercised by DC Power Panel, [Fig. 7.3](#).



**Fig. 7.3. Location of the controls of DC power**

- |  |   |
|--|---|
| <ol style="list-style-type: none"> <li>1. АИ-9В (AI-9V) generator ammeter (during operating as starter-generator, current should not exceed 100 A)</li> <li>2. Rotary switch, for connecting DC power sources to control devices</li> <li>3. (I, II) batteries switches</li> <li>4. Starter-generator switch (installed on the АИ-9В (AI-9V) engine)</li> <li>5. External resistance to (I, II, III) rectifiers voltage control, not used in the game</li> </ol> | <ol style="list-style-type: none"> <li>6. ПРОВЕРКА ОБОРУДОВАНИЯ (EQUIPMENT TEST) switch, for connecting starter-generator to battery bus)</li> <li>7. Lamp indicating ПРОВЕРКА ОБОРУДОВАНИЯ (EQUIPMENT TEST) switch ВКЛ. (ON) position</li> <li>8. External DC 27-29 V Power switch</li> <li>9. Lamp indicating ШРАП-500К (SHRAP-500K) connection to the board</li> <li>10. Lamp indicating disconnecting (I, II, III) rectifiers from rectifiers battery bus when AC generators operating</li> <li>11. (I, II, III) rectifiers switches</li> </ol> |
|--|---|

The rectifiers and batteries load is controlled by ammeter indications. Each DC power potential is controlled by DC voltmeter indications. The DC voltmeter and ammeter are located on the right side console ([Fig. 7.2](#), 2). Each DC power potential is controlled by connecting the DC voltmeter to this DC power by the rotary switch



## AC Power Control

AC power control (energizing, voltage control, load control) is exercised by AC Power Panel, [Fig. 7.4](#).

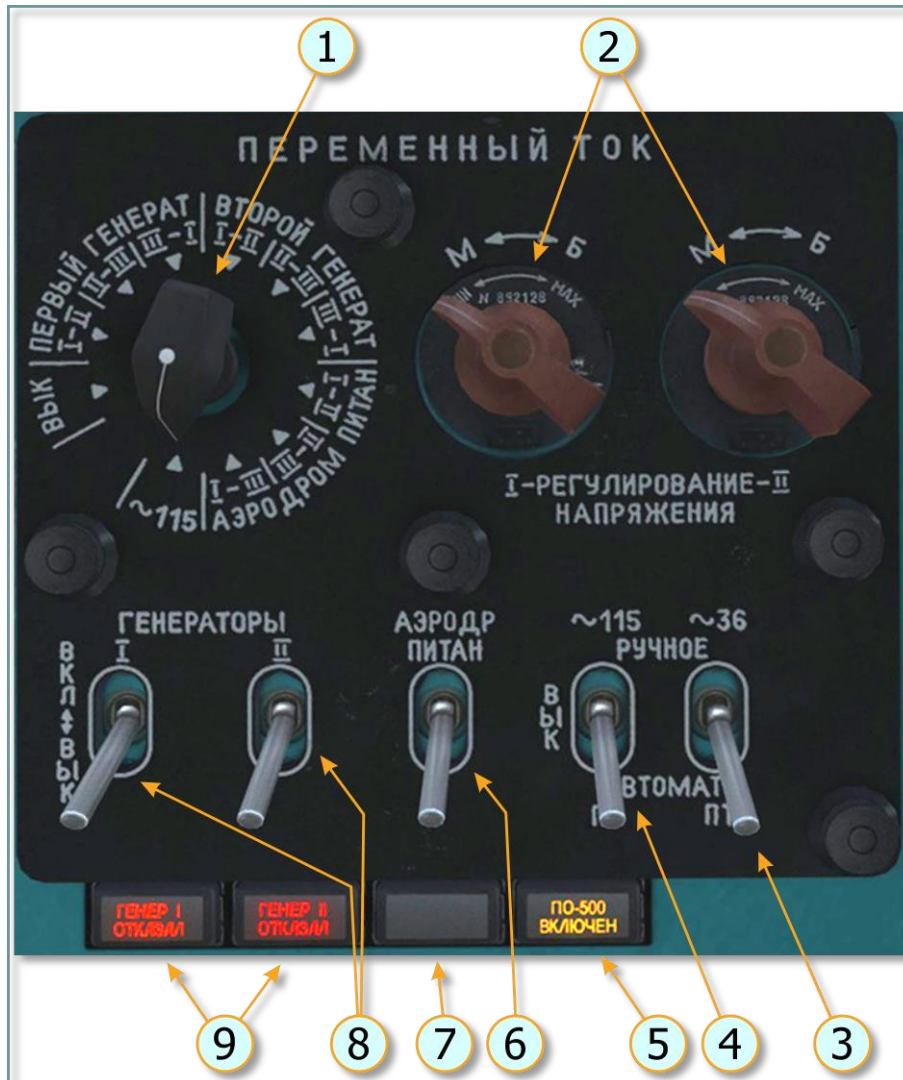

**Fig. 7.4. Location of the controls of AC power**

1. Rotary switch, for connecting AC power sources to control devices
2. External resistance to (I, II) AC generators voltage control, not used in the game
3. 36 VAC ПТ (PT) Inverter switch. Three position switch, РУЧНОЕ (MANUAL) (up), ВЫКЛ (OFF) (center), and АВТОМАТ (AUTO) (down).
4. 115 VAC ПО (PO) Inverter switch. Three position switch, РУЧНОЕ (MANUAL) (up), ВЫКЛ (OFF) (center), and АВТОМАТ (AUTO) (down).
5. Lamp indicating single-phase 115 VAC inverter operation
6. External 208 VAC Power switch
7. Lamp indicating ШРАП-400-3Ф (SHRAP-400-3F) connection to the board
8. (I, II) AC generators switches
9. Lamp indicating (I, II) AC generators failure



The rectifiers load is controlled by ammeter indications. Each AC power potential is controlled by AC voltmeter indications. The AC voltmeter and ammeter are located on the right side console (Fig. 7.2, 3), Each AC power potential is controlled by



connecting the AC voltmeter to this AC power by the rotary switch.

#### 7.1.4. Normal operation

Flight preparation and flight operation electric equipment procedures are set forth in the section [9.1](#).

#### 7.1.5. Failures

##### *INDICATIONS:*

- the PI-65 (RI-65) voice recorder message: "Отказал первый генератор" ("The first generator failure") ("Отказал второй генератор") ("The second generator failure");
- the ГЕНЕРАТОР I ОТКАЗАЛ (I GENERATOR FAILURE) (ГЕНЕРАТОР II ОТКАЗАЛ) (II GENERATOR FAILURE) indicator lamp on the AC Power Panel comes on;
- Failed generator ammeter indicator goes to zero
- After setting voltage control switch to the position of failed generator, voltmeter indicator goes to zero.

##### *CREW PROCEDURE:*

- Set failed generator ГЕНЕРАТОРЫ I (II) (GENERATORS I (II)) switch to the ВЫК. (OFF) position;
- Turn the main and tail rotor deice system off. For this purpose, on the Deice System panel of the left side console:
  - In case of flight operation with manually energized Deice System, make sure that the ДВИГ. ПЗУ ЛЕВ. (ENGINE DUST PROTECTION DEVICE LEFT) switch set to the ВКЛ. (ON) position, ДВИГ. ПЗУ ПРАВ. (ENGINE DUST PROTECTION DEVICE RIGHT), СТЕКОЛ (WINDSHIELD) switches set to the РУЧНОЕ (MANUAL) position. Then set the ОБЩЕЕ РУЧН.-АВТОМ. (GENERAL MANUAL-AUTO) switch to the АВТОМ. (AUTO) position and press the ВЫК. (OFF) button.
  - In case of flight operation with automatically energized Deice System, make sure that the ОБЩЕЕ РУЧН.-АВТОМ. (GENERAL MANUAL-AUTO) switch set to the АВТОМ. (AUTO) position and the ДВИГ. ПЗУ ЛЕВ. (ENGINE DUST PROTECTION DEVICE LEFT) switch set to the ВКЛ. (ON) position. Then set ДВИГ. ПЗУ ПРАВ. (ENGINE DUST PROTECTION DEVICE RIGHT), СТЕКОЛ (WINDSHIELD) switches to the РУЧНОЕ (MANUAL) positions and press the ВЫК. (OFF) button.
- Decide about further mission completion.

NOTE. After one generator failing, another operating generator fully supplies power to all helicopter electrical components except for the main and tail rotors deice system.

## BOTH AC GENERATORS FAILURE

### *INDICATIONS:*

- The РИ-65 (RI-65) voice recorder message: "Отказал первый генератор" ("The first generator failure"), "Отказал второй генератор" ("The second generator failure");
- The ГЕНЕРАТОР I ОТКАЗАЛ (I GENERATOR FAILURE), ГЕНЕРАТОР II ОТКАЗАЛ (II GENERATOR FAILURE) indicator lamps on the AC Power Panel come on;
- Both generator ammeter indicators go to zero
- After setting voltage control switch to the ПЕРВЫЙ ГЕНЕРАТОР (I GENERATOR), ВТОРОЙ ГЕНЕРАТОР (II GENERATOR) positions voltmeter indicators go to zero.

Failure of both generators results in automatically connecting of power to the battery bus. The following flight essential equipment and systems will receive power:

- The АИ-9В (AI-9V) Engine
- The ПО-500 (PO-500) and ПТ-200Ц (PT-200Ts) Inverters
- ЭМИ-3РИ (EMI-3RI) and ЭМИ-3РВИ (EMI-3RVI) Three-pointer indicators
- The rotor pitch indicator
- The 2ИА-6 (2IA-6) engine gauge and PT12-6-20 (RT12-6-20) engine temperature limiters
- The ИВ-500Е (IV-500E) engine vibration monitors
- The ИР-117 (IR-117) mode indicator
- The main and backup hydraulic systems
- The ГА-19 (GA-19) magnet crane in the engine control system
- The left pitot tube heater
- The fire protection system
- Cockpit dome lights and group 2 red lighting
- Cargo cabin lighting
- The navigation lights
- The copilot's ФПП-7 (FPP-7) search/landing light
- МСЛ-3 (MSL-3) anticollision light
- The АРК-9 (ARK-9) ADF set and the P-860 (R-860) radio set
- The СПУ-7 (SPU-7) interphone system
- The pilot's attitude indicator АГБ-3К (AGB-3K)
- Radar altimeter РВ-5 (RV-5)
- Magnetic recording system МС-61 (MS-61)
- Equipment САРПП-12ДМ (SARPP-12DM)
- The external cargo hook ДГ-64 (DG-64)
- The external store emergency jettison circuits
- The pilot's windshield wiper
- The fuel pumps
- The fuel valve
- The fuel system fire valves

- The engine inlet anti-ice system (bleed air)
- The РИО-3 (RIO-3) ice formation warning sensor
- The ЭКСР-46 (EKSR-46) signal flares
- ЛПГ-150М (LPG-150M) winch (rescue hoist)
- The СПУУ-52-1 (SPUU-52) tail rotor pitch limit control panel
- РИ-65 (RI-65) voice data equipment
- The ЭМТ-2М (EMT-2M) mag brakes
- The ГА-192 (GA-192) collective clutch release valve solenoid.

#### *CREW PROCEDURE:*

- Set ГЕНЕРАТОРЫ I, II (GENERATORS I, II) switches to the ВЫК. (OFF) position;
- Turn the main and tail rotor deice system off. For this purpose, on the Deice System panel of the left side console:
  - In case of flight operation with manually energized Deice System, make sure that the ДВИГ. ПЗУ ЛЕВ. (ENGINE DUST PROTECTION DEVICE LEFT) switch set to the ВКЛ. (ON) position, the ДВИГ. ПЗУ ПРАВ. (ENGINE DUST PROTECTION DEVICE RIGHT) switch set to the РУЧНОЕ (MANUAL) position. Then set ОБЩЕЕ РУЧН.-АВТОМ. (GENERAL MANUAL-AUTO), СТЕКОЛ (WINDSHIELD) switches to the АВТОМ. (AUTO) positions and press the ВЫК. (OFF) button.
  - In case of flight operation with automatically energized Deice System, make sure that ОБЩЕЕ РУЧН.-АВТОМ. (GENERAL MANUAL-AUTO), СТЕКОЛ (WINDSHIELD) switches set to the АВТОМ. (AUTO) position and the ДВИГ. ПЗУ ЛЕВ. (ENGINE DUST PROTECTION DEVICE LEFT) switch set to the ВКЛ. (ON) position. Then set the ДВИГ. ПЗУ ПРАВ. (ENGINE DUST PROTECTION DEVICE RIGHT) switch to the РУЧНОЕ (MANUAL) position and press the ВЫК. (OFF) button.
- Start the АИ-9В (AI-9V) engine, see section ...
- After the engine starting, set the РЕЗЕРВН. ГЕНЕРАТ. (STARTER-GENERATOR) switch to the ВКЛ. (ON) position. Set the rotary switch on the DC Power control to the РЕЗЕР. ГЕН. (STARTER-GENERATOR) position. Check the generator potential by the voltmeter; the potential should be within 27-29 V. Check the generator load by the ammeter, the load should not exceed 100 A. The АИ-9В (AI-9V) Engine operating time in the "Генератор" (GENERATOR) mode is up to 30 min
- During specified time, Captain should decide about mission termination and returning to the departure aerodrome or landing on the alternate aerodrome.

NOTE. If all set above electrical components are supplied power only by batteries, their capacity will be sufficient for 6-7 min flight.

## **7.2. Fuel System**

Fuel system allocates appropriate quantity of fuel onboard and ensures uninterrupted fuel feeding of main engines, auxiliary power unit and kerosene-combustion heater in

all modes of helicopter operation. Service fuel cell Left saddle tank Right saddle tank  
Auxiliary tank foam-filled

### 7.2.1. Fuel Storage Location

Onboard helicopter, fuel is located in three main fuel tanks lined with self-sealing polyurethane (PU) foam: two saddle tanks are located on either side of fuselage and one service fuel cell is located in container behind main gear, [Fig. 7.5](#)

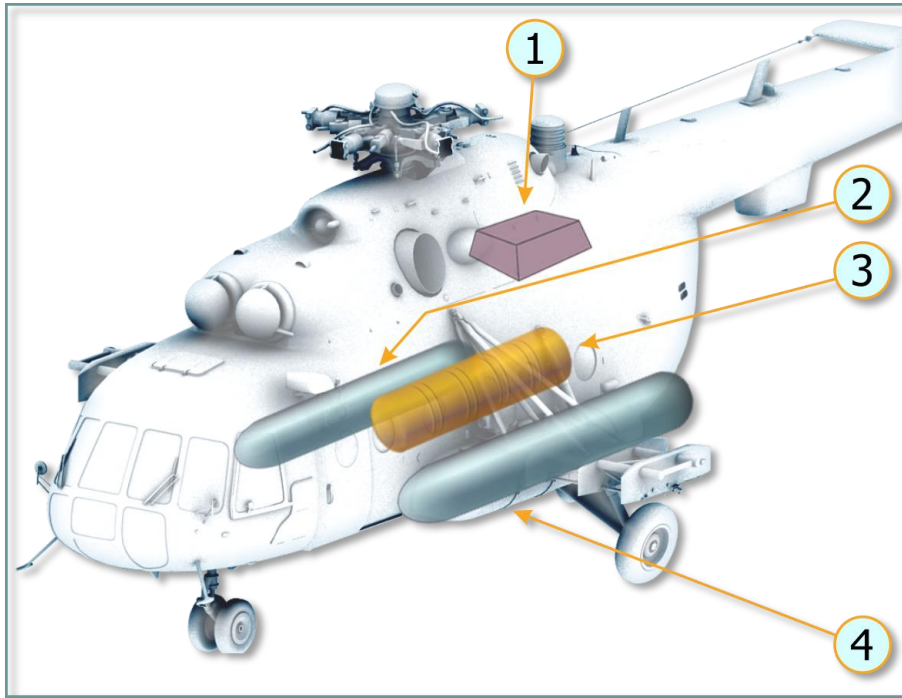

**Fig. 7.5. Location of Fuel Systems Units**

- |                      |   |
|----------------------|---|
| 1. Service fuel cell | 3. Left auxiliary tank (not implemented in the simulator) |
| 2. Right saddle tank | 4. Left saddle tank                                       |

For increase in flight range and duration, one or two auxiliary fuel tanks may be installed inside fuselage (not implemented in the simulator).

Fuel tanks capacity in ltr/kg:

service fuel cell with foam-filled	415/322
right saddle tank with foam-filled	1040/832
left saddle tank with foam-filled	1130/904
auxiliary tank with foam-filled	895/694 (not modeled)

### 7.2.2. Fuel Distribution System

Reliable operation of fuel system is ensured by pumps, valves, pressure sensors, solenoid and shut-off valves, [Fig. 7.6](#)

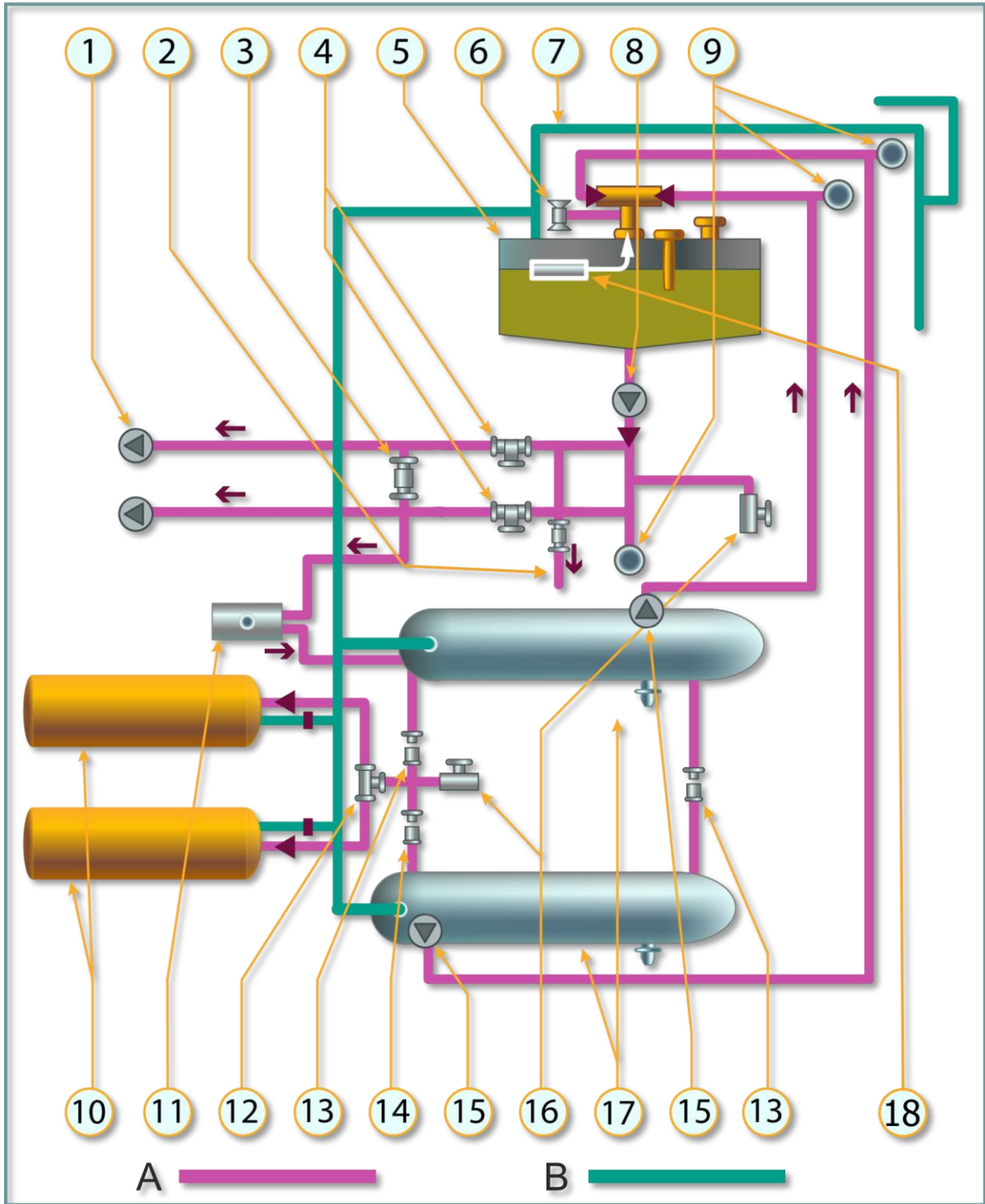

**Fig. 7.6. Fuel System Diagram**

- |  |  |
|--|--|
| 1. Pumps of engines ДЦН-70А,                     | 10. Auxiliary tanks (not implemented in the simulator) |
| 2. Line to engine АИ-9В, with cock 610200А       | 11. Kerosene-combustion heater КО-50                   |
| 3. Solenoid valve 610200А КО-50                  | 12. Bypass cock 637000                                 |
| 4. Emergency shut-off cock 768600МА (electrical) | 13. Shut-off cocks 768600МА                            |
| 5. Service fuel cell                             | 14. Shut-off cock 633600А                              |
| 6. Shut-off cock 768600МА of fuel bypass line    | 15. Pumps ЭЦН-91                                       |



- |                              |                           |
|------------------------------|---------------------------|
| 7. Breathing line            | 16. Drain valves          |
| 8. Pump 463Б                 | 17. Saddle tanks          |
| 9. Pressure detectors СД-29А | 18. Float valve 766300А-1 |
|                              | А – Fuel feed line        |
|                              | В – Breathing lines       |

Helicopter fuel distribution system comprises the following: electric driven centrifugal fuel pump 463Б (8); two centrifugal fuel pumps ЭЦН91С (15); electric driven fuel pump 748Б (of heater КО-50, not shown); float valve 766300А-1 (18); five shut-off cocks 768600МА (6, 13); one shut-off cock 633600А (14); two solenoid valves 610200А (2, 3) for feed lines of engine АИ-9 and heater КО-50 accordingly; bypass cock 637000 (12); fuel filter 11 ТФ30 СТ (not shown); check valves block (not shown); pipes and hoses.

From saddle tanks, fuel is fed to service fuel cell by two pumps ЭЦН-91С (15) via pipelines; pump 463Б (8) distributes fuel from service fuel cell for feeding of engines ТВ3-117ВМ. In the lines running from pump 463Б to engines, emergency shut-off cocks 768600 МА (4) are fitted.

For feeding of engine АИ-9В and kerosene-combustion heater fuel is taken from the line running to the right engine ТВ3-117ВМ, upstream the emergency shut-off cock.

This scheme (Fig. 7.6) does not contain the engines fuel shutoff levers, which are opened / closed by crew for engines start / shut down.

### ***Function of Fuel System Units***

*ELECTRIC DRIVEN CENTRIFUGAL FUEL PUMP 463Б* (8) creates fuel overpressure at the inlet of main fuel pumps of engines ТВ3-117ВМ and engine АИ-9В, and inlet of kerosene-combustion heater КО-50 pump 748Б as well.

Pump 463Б is located outside service fuel cell, in its lower part.

Pump 463Б failure does not lead to interruption of engines operation: fuel would be fed from service fuel cells to engines by gravity.

Pump power supply circuit is connected to battery bus via circuit breaker ТОПЛИВНАЯ СИСТЕМА. НАСОСЫ ТОПЛИВН. БАКОВ-РАСХОД (FUEL SYSTEM. FUEL TANKS PUMPS - FLOW) located on the breakers' right section of cockpit electric panel.

Pump is activated by switch НАСОСЫ БАКОВ-РАСХОД (TANKS PUMPS - FLOW) installed on the mid section of electric panel.

*ELECTRIC DRIVEN CENTRIFUGAL PUMPS ЭЦН-91С* (15) located in the mounting units inside saddle tanks (in the front part of left tank and in the rear part of right tank) pump fuel to service fuel cell.

Pumps motors power supply circuits are connected to battery bus via circuit breakers ТОПЛИВНАЯ СИСТЕМА. НАСОСЫ ТОПЛИВН. БАКОВ-ЛЕВОГО (FUEL SYSTEM. FUEL TANKS PUMPS - LEFT) and ТОПЛИВНАЯ СИСТЕМА. НАСОСЫ ТОПЛИВН. БАКОВ-ПРАВОГО (FUEL SYSTEM. FUEL TANKS PUMPS - RIGHT) on the breakers' right section of cockpit electric panel. Pumps are turned on by switches НАСОСЫ БАКОВ-ЛЕВЫЙ (TANKS PUMPS - LEFT) and НАСОСЫ БАКОВ-ПРАВЫЙ (TANKS PUMPS - RIGHT), on the mid section of cockpit electric panel.

*ELECTRIC DRIVEN FUEL PUMP 748Б* (11) of geared type for fuel feed to kerosene-combustion heater КО-50 injectors, installed in kerosene-combustion heater bay.

Pump power supply and control circuit is connected to rectifier bus via circuit breaker of heater КО-50, located on the breakers right section of cockpit electric panel. Pump activates after heater activation.

*FLOAT VALVE 766300A-1* (18) prevents overflow of service fuel cell when fuel is pumped from saddle tanks; it is installed in service fuel cell and fixed to its plate.

During pumping, when service fuel cell is not yet filled completely, valve goes off its seat under fuel pressure thus opening passage area for fuel flow. Fuel goes to the tank via valve body openings and fills the tank. After tank is filled the valve float takes top position and shuts fuel supply to the tank.

*EMERGENCY SHUT-OFF COCKS 768600A* (4) are operated remotely via electric circuits; they serve for shutting and opening of fuel lines. The Emergency Shut-off Cocks installed in the main gear part (see [Fig. 7.7](#) 1, 2). Designed to shutoff of fuel lines in case of fire.

Emergency shut-off cocks power supply circuits are connected to battery bus via circuit breakers *ТОПЛИВНАЯ СИСТЕМА. ПЕРЕКРЫВ. КРАНЫ-ЛЕВЫЙ* (FUEL SYSTEM. SHUT-OFF COCKS - LEFT) and *ТОПЛИВНАЯ СИСТЕМА. ПЕРЕКРЫВ. КРАНЫ-ПРАВЫЙ* (FUEL SYSTEM. SHUT-OFF COCKS - RIGHT) on the breakers' right section of cockpit electric panel. The cocks are opened and shut by switches *ПЕРЕКРЫВ. КРАНЫ-ЛЕВЫЙ* (SHUT-OFF COCKS - LEFT) and *ПЕРЕКРЫВ. КРАНЫ-ПРАВЫЙ* (SHUT-OFF COCKS - RIGHT), which are located on the electric panel mid section and safeguarded. Shut position of cocks is indicated by lamps *ЛЕВЫЙ ЗАКРЫТ* (LEFT SHUT) and *ПРАВЫЙ ЗАКРЫТ* (RIGHT SHUT), located below those switches.

*TWO FUEL SHUTOFF LEVERS* are installed in the fuel lines of engines TV3-117VM, they cut off fuel (handle) flow upstream engines inlet. It necessary open/close in case start/stop engines by crew members.

*ONE SHUT-OFF COCK* (6) serves for fuel bypassing from saddle tanks to service fuel cell in case of failure of float valve 766300A-1 in shut position. The cock is installed on the service fuel cell plate.

Shut-off cock power supply circuit is connected to battery bus via circuit breaker *ТОПЛИВНАЯ СИСТЕМА-КРАН ПЕРЕПУСК* (FUEL SYSTEM - BYPASS COCK) located on the right section of cockpit electric panel. The cock is opened and shut by switch *ТОПЛИВНАЯ СИСТЕМА-ПЕРЕПУСК* (FUEL SYSTEM - BYPASS) located on the mid section of electric panel.

*TWO SHUT-OFF COCKS* are installed in tanks cross-feeding lines that interconnect saddle tanks in their front and rear parts. They serve for uniform fuel use from saddle tanks in case of failure of either pump ЭЦН-91С.

Normal position of cocks is open.

The cocks shall be shut when helicopter enters hazardous zone, to save fuel in one saddle tank if another gets damaged.

Cross-feeding cocks power supply circuits are connected to battery bus. The cocks are opened and shut by safeguarded switch *КОЛЬЦЕВ БАКОВ ЗАКР-ОТКР* (TANKS CROSS-FEEDING OPEN-SHUT) located on the mid section of electric panel. Shut position of cocks is indicated by yellow lamp *КОЛЬЦЕВ ОТКЛ.* (CROSS-FEEDING OFF) below the switch.

*SHUT-OFF COCK 633630* (not implemented in the simulator) shuts front cross-feeding line. The cock is controlled manually and should be open. The cock is shut in case of right tank removal and fuel drain from auxiliary tanks.

*SOLENOID VALVES 610200A* ensure control of fuel feed to engine АИ-9В and kerosene-combustion heater КО-50. The solenoid valve in the fuel line of engine АИ-9В is installed in the main gear compartment. It opens automatically after start button of engine АИ-9В is pressed. Cock closes when engine АИ-9В shuts down.

The solenoid valve in the fuel feed line of kerosene-combustion heater КО-50 is installed on the cargo compartment ceiling panel below emergency shut-off cock; it opens automatically when heater is started and shuts when heater is turned off.

*BYPASS COCK 637000* (not implemented in the simulator) serves for connection of one or two auxiliary tanks to the front line connecting the saddle tanks, and for fuel drain from auxiliary tanks.

The cock is opened manually. It is installed under cargo compartment deck close to shut-off cock 633600A. The cock ensures fuel use from auxiliary tanks: either separate or simultaneous.

*CHECK VALVES BLOCK* includes two check valves installed in the lines of fuel transfer from saddle tanks to service fuel cell. The valves pass fuel in one direction only – to service fuel cell. They are installed on the service fuel cell plate upstream float valve and shut-off cock.

The system of pipelines and check valves ensures fuel feed of engines from either pump of saddle tanks, if another fails.

*PRESSURE DETECTORS CD-29A (SD-29A)* turn off the lamps, which indicate running of transfer pumps ЭЦН-91С or pump 463Б if pressure in relevant line drops below 0.5 kg/cm<sup>2</sup>.

### 7.2.3. Monitoring and Control of Fuel System Operation

#### *Fuel System Units Control*

The units of fuel system are controlled from the fuel system control panel located on the mid section of electric panel, [Fig. 7.7](#). Moreover, there are manual shut-off cocks that are not implemented in the simulator.



**Fig. 7.7. Fuel System Control Panel, Center overhead console**

1. Indicator lamp of left fuel shut-off cock and its closed position

6. Switch and indicator lamp of RIGHT tank ЭЦН-91С pump operating status

2. Indicator lamp of right fuel shut-off cock and its closed position
3. Indicator lamp of fuel cross-feeding disabling (interconnecting line is shut)
4. Switch of saddle tanks cross-feed enabling solenoid valves (top position: interconnecting line is open – ОТКРЫТА)
5. Switch of solenoid valve for manual fuel bypassing from saddle tanks to service fuel cell (in case of service fuel cell float valve failure). Normal position is ЗАКРЫТО (CLOSED) - down
7. Switch and indicator lamp of LEFT tank ЭЦН-91С pump operating status
8. Switch and indicator lamp of FEED tank 463Б pump operating status
9. Switch for selecting operating mode of lamps indicating 100% fill of tanks. The lamps are located close to fillers, not implemented in the simulator

### Fuel System Operation Monitoring

Operation of fuel system may be monitored by pumps' indicator lamps and fuel gauge, which indicates remaining fuel quantity in litres, separately or in total (for saddle tanks and service fuel cell), Fig. 7.8:



**Fig. 7.8. Fuel gauge**

1. Inner scale, for reading of fuel quantity in separate tanks (highlighted red)
2. Outer scale for reading total fuel quantity (highlighted blue)

For tanks switching over, fuel gauge switch, [Fig. 7.9](#) is used:

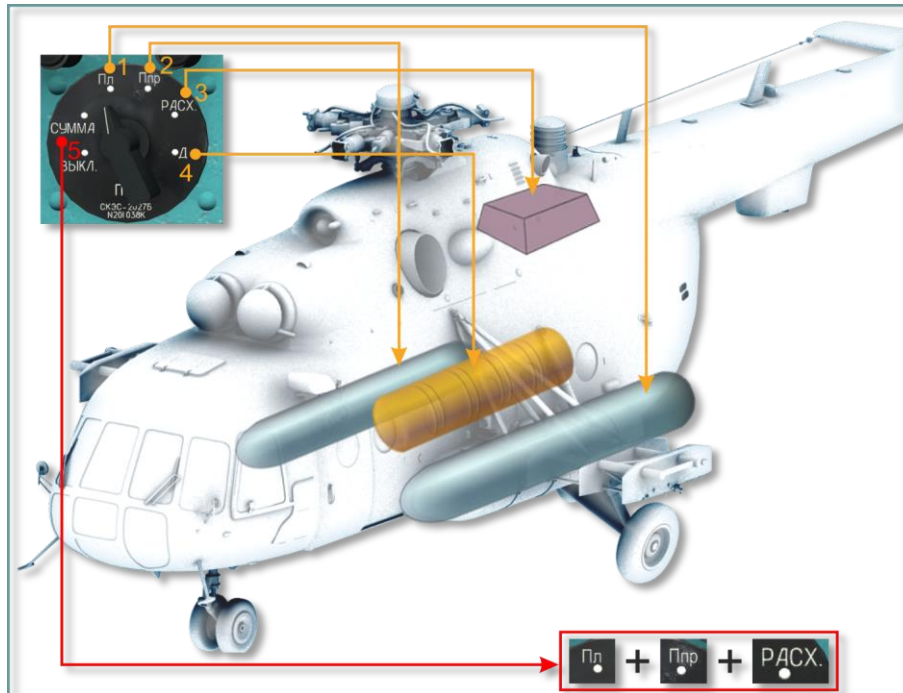

**Fig. 7.9. Fuel Gauge Switch**

Fuel gauge switch positions  
 1. Пл – Left Saddle tank  
 2. Ппр – Right Saddle tank

3. РАСХ – Service fuel cell  
 4. Д – Auxiliary Tank (not implemented in the simulator)  
 5. СУММА – total fuel quantity in saddle tanks and service fuel cells

## 7.2.4. Normal Operation

### *Before Start*

1. Set the following circuit breakers to on: ТОПЛИВНАЯ СИСТЕМА. ТОПЛИВОМЕР (FUEL SYS FUEL GAUGE); НАСОСЫ ТОПЛИВН. БАКОВ-РАСХОД-ЛЕВОГО-ПРАВОГО (FUEL TANKS PUMPS - FLOW - LEFT - RIGHT); ПЕРЕКРЫВ КРАНЫ ЛЕВЫЙ-ПРАВЫЙ (SHUT-OFF COCKS LEFT - RIGHT), КРАН ПЕРЕПУС.



(BYPASS COCK) on the breakers' mid section. At that, lamps ЛЕВЫЙ ЗАКРЫТ (LEFT CLOSED), ПРАВЫЙ ЗАКРЫТ (RIGHT CLOSED)

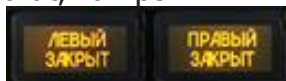

on the mid section of electric panel come on ([Fig. 7.7](#), 1, 2);

2. Check fuel quantity using fuel gauge indicator;



3. Check functioning of backing up and transfer pumps by alternate training of them: make sure that lamps РАСХОД РАБОТАЕТ (FLOW ON), ЛЕВЫЙ (ПРАВЫЙ)

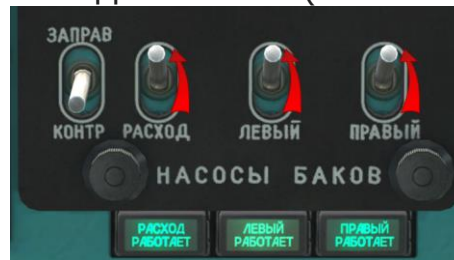

РАБОТАЕТ (LEFT (RIGHT) ON) come on;

4. Prior to starting auxiliary power unit and main engine, turn on the fuel gauge, backing up and transfer pumps to check functioning of them by relevant indicator lamps coming on; open emergency shut-off cocks: indicator lamps ЛЕВЫЙ ЗАКРЫТ (LEFT CLOSED) and ПРАВЫЙ ЗАКРЫТ (RIGHT CLOSED)



### **Operation in Flight**

Fuel pumped from outboard pumps goes to service fuel cells by two fuel lines via check valves and float valve; from service fuel cell, fuel is fed to engines TB3-117BM via open emergency shut-off cocks.

In flight, it is required to monitor lamp indicating pumps operation and remaining fuel in service fuel cell (once in 5 to 10 min).

### **7.2.5. Failures**

Indications of failure and appropriate actions.

#### ***Failure of service fuel cell float valve (not implemented)***

Failure of service fuel cell float valve has the following indication:

- with saddle tanks' pumps running, fuel quantity in service fuel cell decreases.

### **Crew Procedure**

- Take decision about continuing flight.



- Set switch ПЕРЕПУСК (BYPASS) on the panel ТОПЛИВНАЯ СИСТЕМА (FUEL SYSTEM) (Fig. 7.7, 5) to ОТКР. (OPEN, up): fuel will be delivered to service fuel cell through open shut-off cock, with float valve bypassing. Then, further fuel use should be adjusted manually while maintaining fuel quantity in service fuel cell at the level of 370...390 litres and avoiding its overflow.

### ***Failure of One/Both Transfer Pump***

Failure of transfer pumps has the following indications:

- indicator lamp НАСОСЫ БАКОВ (TANKS PUMPS): ЛЕВЫЙ РАБОТАЕТ (LEFT RUNNING) or ПРАВЫЙ РАБОТАЕТ (RIGHT RUNNING)



goes off, or both lamps go off;

- voice recorder message "Отказали насосы основных топливных баков" (Main fuel tanks' pumps failure);
- fuel quantity reduction in service fuel cell.

### **Crew Procedure**

*IF ONE TRANSFER PUMP FAILS:*

- Turn off the failed pump.
- In case of either pump failure, another pump ensures service fuel cell fill.
- Make sure that fuel is fed to service tank and continue your mission.

*IF BOTH TRANSFER PUMPS FAIL:*

- Turn off НАСОСЫ БАКОВ ЛЕВЫЙ, ПРАВЫЙ (TANKS PUMPS LEFT, RIGHT)



- Abort the mission.
- Land on the nearest airfield or an appropriate site noticed in flight.

**WARNING.** Please note that fuel quantity in service fuel cell is sufficient for flight at altitude 500 m and speed 220 km/h for 21 min to the range of 70 km.

### ***Service fuel cell Backing Pump Failure***

Failure of service fuel cell backing pump has the following indications:

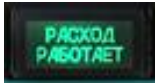
- short-term drop of engines RPM by 2-5%, fuel pressure by 3-4 kgf/cm<sup>2</sup> and main rotor RPM by 1-3%;
- green indicator lamp РАСХОД РАБОТАЕТ (FLOW ON)  on the mid section of electric panel goes off;
- voice recorder message "Отказал насос расходного бака" (Service fuel cell pump fails).

### **Crew Procedure**

- if backing pump fails, continue the mission. At that, normal operation of engines are ensured by pumps of engine ДЦН-70А.



- turn pump off

- act smoothly when changing engine operating parameters and helicopter piloting.

## 7.3. Hydraulic System

### 7.3.1. Brief Description

Helicopter has two independent hydraulic systems:

- main system;
- backup system

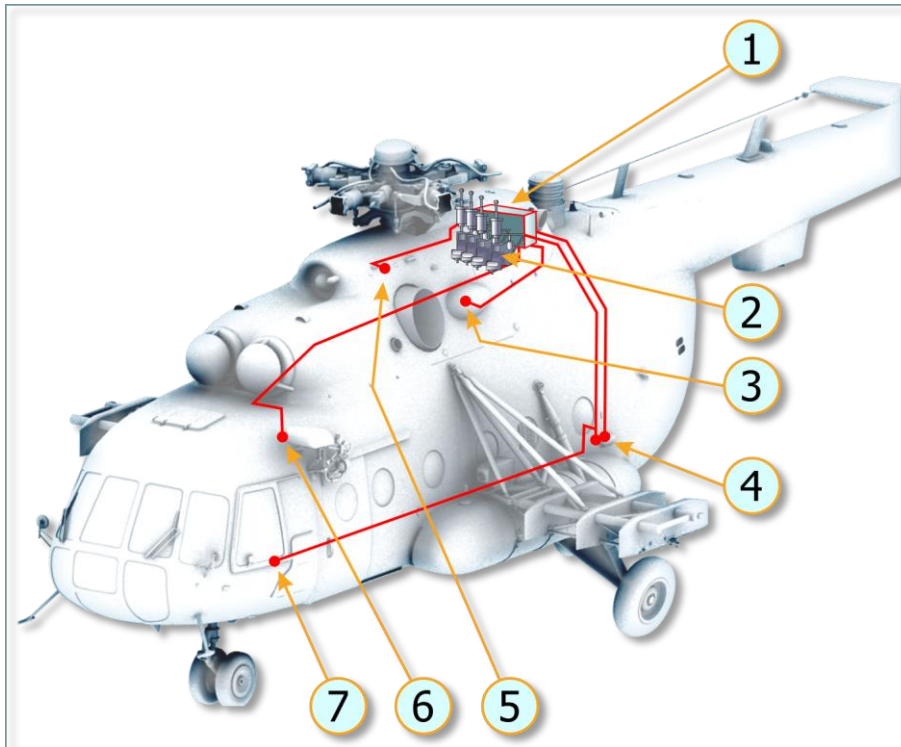

**Fig. 7.10. Location of Hydraulic System Units**

- |                                       |   |
|---------------------------------------|---|
| 1. Hydraulic units' panel             | 5. Backup system hydraulic pump HLI-39M             |
| 2. Hydraulic boosters                 | 6. Hydraulic lock cylinder                          |
| 3. Main system hydraulic pump HLI-39M | 7. Collective pitch control clutch dumping cylinder |
| 4. Charging connections panel         |   |

(1) *HYDRAULIC UNITS CYLINDER* serves for compact location of both hydraulic systems units (solenoid valves, pressure accumulators, filters, check valves);

(2) *HYDRAULIC BOOSTERS* convert manual control rods motion autopilot signals into power rod travel;

(3) *HYDRAULIC PUMP HLI-39M* of main system serves for creation of pressure in main system line;

(4) *CHARGING CONNECTIONS PANEL* is used for charging of hydraulic systems with power fluid and check of those system from ground unit (not implemented in the simulator);

(5) *HYDRAULIC PUMP HLL-39M* of backup system serves for creation of pressure in backup system line;

(6) *HYDRAULIC LOCK CYLINDER* serves for force creation on cyclic pitch control stick when swash plate angle reaches  $2^{\circ}12'$ . Force makes 16 kg (not implemented in the simulator);

(7) *COLLECTIVE PITCH CONTROL CLUTCH DUMPING CYLINDER* serves for release of collective pitch control forces, when pressing on collective pitch control button (not implemented in the simulator)

### **Main Hydraulic System**

Main hydraulic system serves for feeding of combined control units (hydraulic boosters) KAY-30Б (KAU-30B, installed in longitudinal, lateral and collective pitch control systems) and PA-60Б (RA-60B, lateral control system), collective pitch control clutch dumping cylinder, variable lock cylinder (lateral control).

Hydraulic boosters KAY-30Б and PA-60Б can operate in two modes:

- manual control (by pilot);
- combined control (autopilot on).

### **Backup Hydraulic System**

Backup hydraulic system duplicates main hydraulic system; it performs main system functions if that fails. Backup system is activated automatically, if main system pressure drops to  $30 \pm 5$  kgf/cm<sup>2</sup>.

In case of main system failure and backup system activation, the following units are deactivated automatically: autopilot АП-34Б (AP-34B), collective pitch control clutch dumping system and hydraulic lock. At that, hydraulic boosters are operated in manual mode only; to create optimum forces for collective pitch control movement, clutch tightening is to be adjusted (not implemented in the simulator).

### **Control of Hydraulic Systems**

Hydraulic systems are controlled from hydraulic system panel, [Fig. 7.11](#)



**Fig. 7.11. Hydraulic System Control Panel**

- |  |                                      |
|--|--------------------------------------|
| 1. Main system switch                          | 5. Backup system pressure gauge      |
| 2. Main system pressure gauge                  | 6. Backup system switch              |
| 3. Lamp indicating activation of main system   | 7. Backup system deactivation button |
| 4. Lamp indicating activation of backup system |                                      |

Button ОТКЛ.ДУБЛИР. (DEACTIVATE BACKUP SYS) (Fig. 7.11, 7) for stable switching from backup system to main one during engine start and hydraulic system ground check (ground check is not implemented in the simulator).

Technical details of hydraulic systems are given in Table 7.1.

**Table 7.1**

Power fluid	масло АМГ-10
Operating pressure in main and backup hydraulic systems	(4500± 300...6500 <sup>+800</sup> <sub>-200</sub> ) kPa [(45±3...65 <sup>+8</sup> <sub>-2</sub> ) kgf/cm <sup>2</sup> ]
Ambient air operation range for normal operation of hydraulic systems	от -50 до +60 °C
Power fluid permissible temperature	до 70°C



AMГ-10 oil quantity in hydraulic system	22 l (no 11)
System pressure for pump switching to operating mode (hydraulic system feeding)	(4500±300) kPa [(45±3) kgf/cm <sup>2</sup> ]
System pressure of pump switching to idle mode (fluid pumping to tank)	(6500 <sup>+800</sup> <sub>-200</sub> ) kPa [(65 <sup>+8</sup> <sub>-2</sub> ) kgf/cm <sup>2</sup> ]
Minimum pressure in main system for hydraulic boosters feed switching to backup system	(3000±500) kPa [(30±5) kgf/cm <sup>2</sup> ]

### 7.3.2. Normal Operation

#### *Check before starting the engine*

Set circuit breakers ГИДРОСИСТ. ОСНОВН/ДУБЛИР. (HYDRO SYS MAIN/BACKUP)



to on. Make sure that hydraulic systems switches are set to ВКЛ (ON)

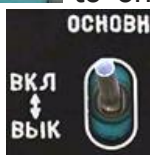

(main and backup hydraulic systems are activated), and backup system switch ГИДРОСИСТЕМА ДУБЛИР. (HYDRO SYS BACKUP) is safeguarded.

#### *During Engine Start*

**Warning!** During engine start with main and backup systems switches set to on, backup system may activate (not main one). At backup system pressure of (2500±160) kPa [(25±1.6) kgf/cm<sup>2</sup>] indicator lamp ДУБЛИР ВКЛЮЧЕНА (BACKUP

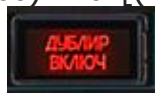



SYS ON) must come on. (At that, electromagnetic relay deactivates main hydraulic system). Pressure read by pressure gauges of both systems will be stabilized within (6500) kPa [(65) kgf/cm<sup>2</sup>]. To switch to operation from main

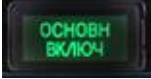

hydraulic system, press button ОТКЛ ДУБЛИР (DEACTIVATE BACKUP SYS) and hold it for 1...1.5 s. Indicator lamp ОСНОВНАЯ ВКЛЮЧЕНА (MAIN SYS ON) must come on and indicator lamp ДУБЛИР ВКЛЮЧЕНА (BACKUP SYS ON) must go off. Pressure in backup system shall drop to (0-500) kPa [(0-5) kgf/cm<sup>2</sup>].

Prior to hydraulic system serviceability check, it is required to switch to main system; for that, press button ОТКЛ. ДУБЛИР. (DEACTIVATE BACKUP SYS) on the mid section of cockpit electric panel and hold it until green indicator lamp ОСНОВН.

ВКЛЮЧ. (MAIN SYS ON)  comes on and red indicator lamp ДУБЛИР. ВКЛЮЧ. (BACKUP SYS ON) goes off.

Make sure that main system pressure increases to 42... 73 kgf/cm<sup>2</sup> . At that, one should pay attention to frequency of main system pressure gauge indicator movement.

### ***Hydraulic System Check During Power Plant Warm-up***

Check operation of hydraulic system controls; for that:

- deflect control stick, pedals and collective pitch control lever alternately, by no more than 1/3 of their full travel, to make sure that controls operate smoothly (no jerks or sticking);
- make sure that operation of controls causes main system pressure variation within 42...73 kgf/cm<sup>2</sup>, no pressure in backup system, green indicator lamp ОСНОВН. ВКЛЮЧЕНА (MAIN SYS ON) is on;
- Set switch (MAIN HYDRO SYS) to ВЫКЛ (OFF). Pressure in main system (downstream valve) will drop to zero; at the moment it passes the value (3000±160) kPa [(30±1.6) kgf/cm<sup>2</sup>] main system pressure detector will operate, indicator lamp ОСНОВНАЯ ВКЛЮЧЕНА (MAIN SYS ON) goes off; when pressure becomes (3000±500) kPa [(30±5) kgf/cm<sup>2</sup>] emergency feeding valve will operate. Pressure in backup system must go up; when pressure reaches (2500±1.6) kPa [(25±1.6) kgf/cm<sup>2</sup>] the backup system pressure detector will operate and indicator lamp ДУБЛИР ВКЛЮЧЕНА (BACKUP SYS ON) must come on. Pressure in backup system grows rapidly and changes within (4500±300...6500 <sup>+800</sup><sub>-200</sub>) kPa [(45±3...65 <sup>+8</sup><sub>-2</sub>) kgf/cm<sup>2</sup>], when controls are moved;
- set main system switch to on and make sure that green indicator lamp ОСНОВН. ВКЛЮЧЕНА (MAIN SYS ON) comes on, pressure in main system is maintained within 42...73 kgf/cm<sup>2</sup>, red indicator lamp ДУБЛИР. ВКЛЮЧЕНА (BACKUP SYS ON) goes off and pressure in backup system drops to zero. For the helicopters with updated electric circuit of hydraulic system: to switch to main system, after setting ГИДРОСИСТЕМА ОСНОВН (HYDRO SYS MAIN) to on, it is required to press button ОТКЛ. ДУБЛИР. (DEACTIVATE BACKUP SYS) on the mid section of cockpit electric panel and hold it until green indicator lamp ОСНОВН. ВКЛЮЧЕНА (MAIN SYS ON) comes on and red indicator lamp ДУБЛИР. ВКЛЮЧЕНА. (BACKUP SYS ON) goes off.

### **7.3.3. Failures**

For indications of failures and appropriate actions refer to [10.7](#)

## 7.4. Anti-Ice System

### 7.4.1. General Description

Helicopter Anti-Ice System serves for icing prevention and ice/water removal from helicopter units (Fig. 7.12) and indication of icing as well. The protected elements are as follows:

- two front glasses of cockpit;
- air intakes including air inlet Particle Separator System (PSS) and engines' inlets;
- main and tail rotor blades.

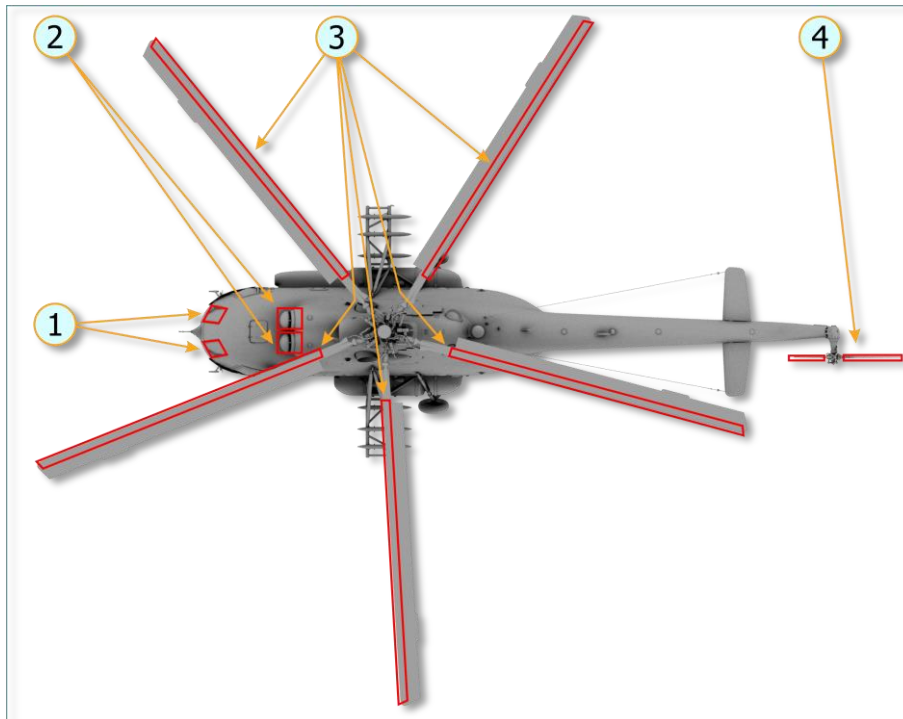

**Fig. 7.12. Anti-Ice System**

- |  |                                      |
|--|--------------------------------------|
| 1. Heated glasses  | 3. Heated parts of main rotor blades |
| 2. Heated parts of air intakes including Particle Separator System and engines' inlets | 4. Heated parts of tail rotor blades |

For icing early warning, helicopter is furnished with ice detector ПИО-3 and visual ice detector.

### 7.4.2. Heated Glasses

Glasses are electrically heated.

Anti-ice system of glasses provides for automatic energizing of glasses heating by CO-121BM ice detector signal and manual switching to glasses heating and wipers also. Glasses heating temperature (30°C) is maintained by temperature regulators ТЭР-1М.

Technical details of heated glasses:

Supply voltage, V	190; 208; 230 or 250
Power demand, W, max.	1930
Current consumption, A, max.	9.65

For adjustment of currents consumed by glasses heating elements, rotary switch ТОКИ ПОТРЕБИТЕЛЕЙ (CONSUMERS CURRENTS) (Fig. 7.18) is to be set to ОБОГРЕВ СТЕКОЛ (GLASSES HEATING), along with current check by dashboard amperemeter. Dashboard amperemeter readings should be within 40-120 A. Current value depends upon simultaneous energizing of glasses heating. To know true value of current, amperemeter readings should be divided by 6.

### Wipers

Heated glasses are equipped with wipers. Wipers serve for removal of water splashes and snow off cockpit heated glasses. Wiper brushes are actuated directly with electric actuators ЭПК-2Т-60.

Electric actuator ЭПК-2Т-60 has four modes of operation: starting mode; the first speed; the second speed; brush return to initial position.

Wipers supply and control circuit is connected to battery bus via circuit breakers (CB) СТЕКЛООЧИСТ. – ЛЕВЫЙ (WIPER – RIGHT) and СТЕКЛООЧИСТ. – ПРАВЫЙ

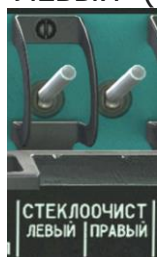

(WIPER – RIGHT). For wiper control, СТЕКЛООЧИСТИТЕЛЬ (WIPER) switches on the left and right section of the electric panel are used, Fig. 7.13

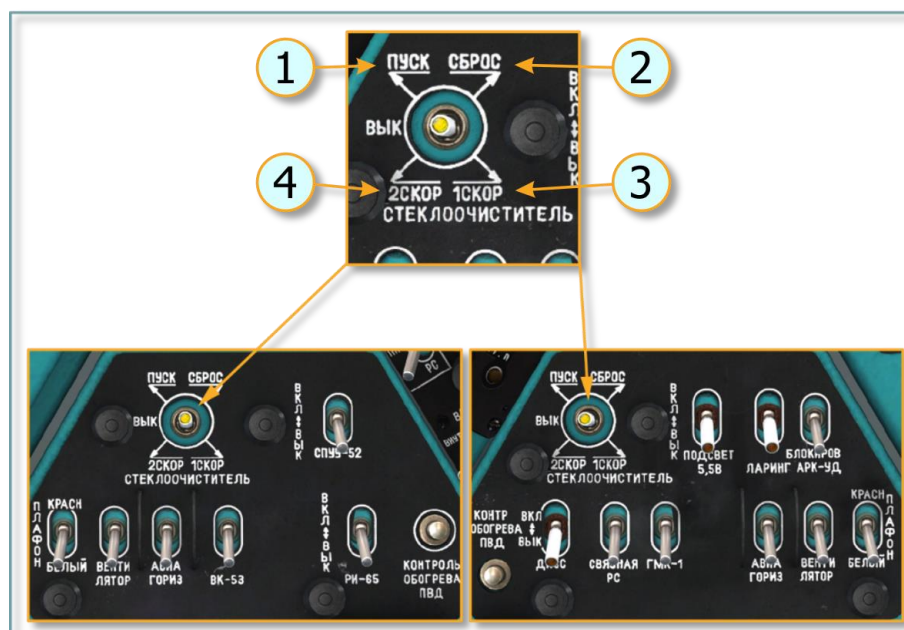

Fig. 7.13. Position of switch СТЕКЛООЧИСТИТЕЛЬ (WIPER)

- |   |  |
|---|--|
| 1. ПУСК (START) – starting operation, the switch should be set to this position, for a short time | 3. 1 СКОР (SPEED 1) – switch position for first speed operation  |
| 2. СБРОС (RESET) – position to stop operation   | 4. 2 СКОР (SPEED 2) – switch position for second speed operation |

The switches have four fixed positions: ПУСК (START), 1 СКОР. (SPEED 1 – 60..90 oscillations per minute), 2 СКОР. (SPEED 2 – 30..60 oscillations per minute) and neutral position corresponding to off position of electric actuator. The fifth position, СБРОС (RESET) is not fixed; it provides automatic return to off position.

To start wiper operation, circuit breakers СТЕКЛООЧИСТИТЕЛЬ – ЛЕВЫЙ (WIPER – RIGHT), СТЕКЛООЧИСТИТЕЛЬ – ПРАВЫЙ (WIPER – RIGHT) should be set to on. Then set switch СТЕКЛООЧИСТИТЕЛЬ (WIPER) to ПУСК (START) position; then, depending upon external conditions (rain or snow rate), the switches should be set to position 1 СКОР (SPEED 1) or 2 СКОР (SPEED 2) (rain and snow on helicopter glasses is not implemented in simulator yet).

In the game, this switch is controlled by the mouse: player must click on one of the five areas, corresponding to operation modes of windshield wipers:

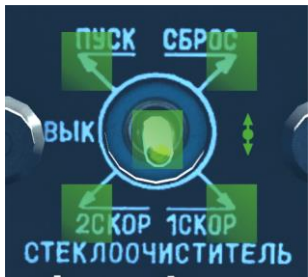

After wiper is switched off, brush may stop at any position and obstruct viewing. To set it to initial limit position, switch СТЕКЛООЧИСТИТЕЛЬ (WIPER) should be set to СБРОС (RESET) and held in that position until brush takes limit position; at that, electric actuator will stop automatically. After wiper is stopped in limit position, switch is to be released; when released, the switch takes neutral (off) position.

### 7.4.3. Anti-Ice System of air inlet Particle Separator System

Air inlet Particle Separator System (PSS) anti-icing system is of combined type (bleed air plus electrical heating); engines' inlets are heated by bleed air only.

Heating hot air is bled from combustor cooling loop (5), Fig. 7.14.



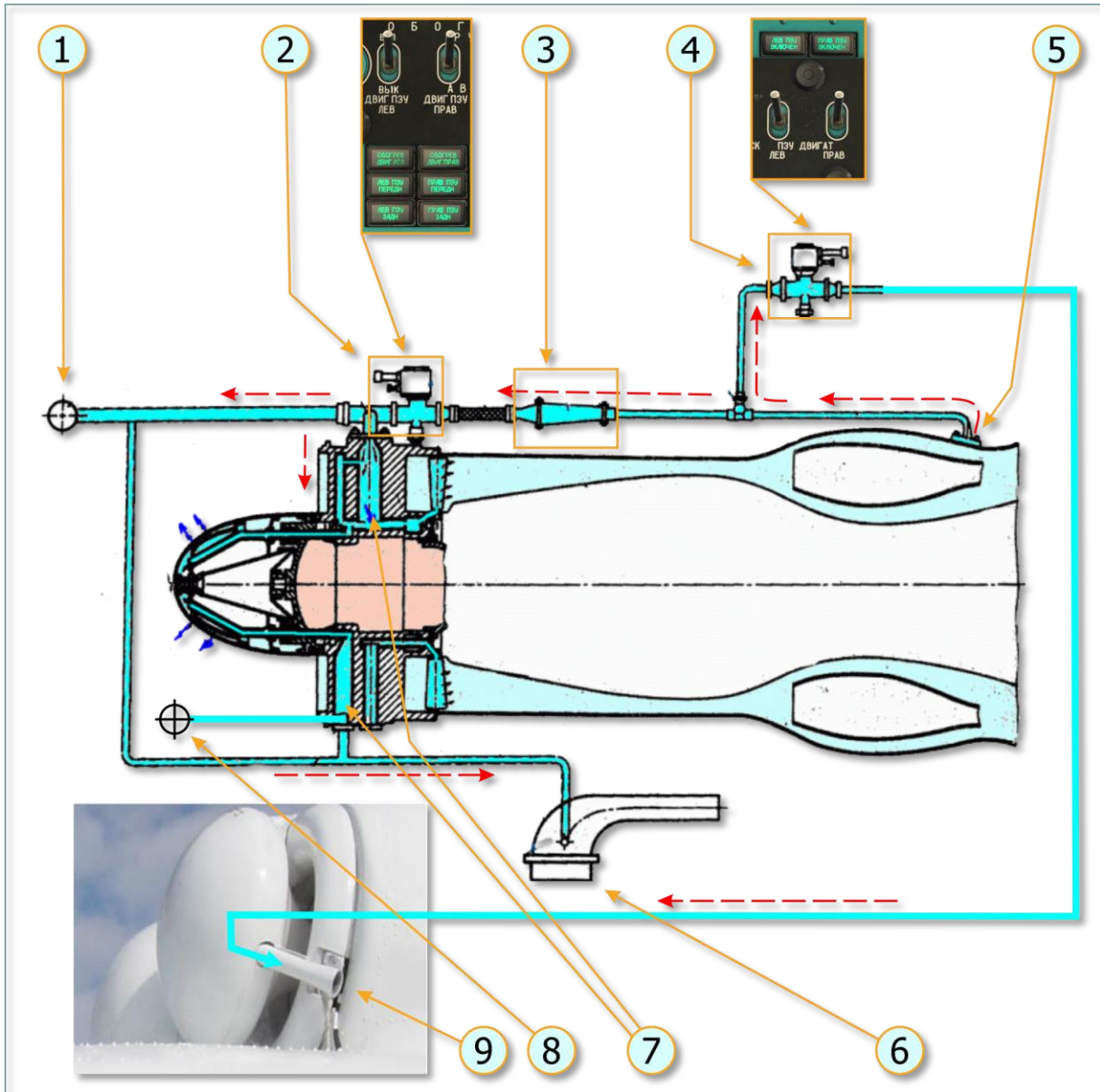

**Fig. 7.14. Diagram of Hot Air Bleed for PSS and Engines' Inlets anti-ice system and for PSS Needs**

- |  |   |
|--|---|
| <ul style="list-style-type: none"> <li>1. Anti-ice system of air intake (intake lip)</li> <li>2. Electric shutter 1919T, which opens hot air flow for anti-ice system needs</li> <li>3. Temperature regulator</li> <li>4. Electric shutter 1919T, which opens hot air flow to PSS ejector (for vacuum creation)</li> </ul> | <ul style="list-style-type: none"> <li>5. Fitting for air bleed from TB3-117BM engine combustor cooling loop</li> <li>6. Heating of HP-3BM governor pump thermal compensator air receiver (for correct operation of governor's systems)</li> <li>7. Heated parts of inlet guide vane (vertical and horizontal supports)</li> <li>8. Air bleed for PSS trap heating</li> <li>9. PSS ejector</li> </ul> |
|--|---|

Either engine has shutter 1919T (2), which opens hot air flow from combustor cooling loop (5).

NOTE. The second shutter (4) serves for air supply to PSS ejector for creation of vacuum, which promotes suction and ejection of dust from engine inlet duct.

In PSS, the following surfaces are heated by hot air ([Fig. 7.15](#)): intake lip and duct surface, PSS trap, HP-3BM governor thermal compensator air receiver ([Fig. 7.14](#), 6).

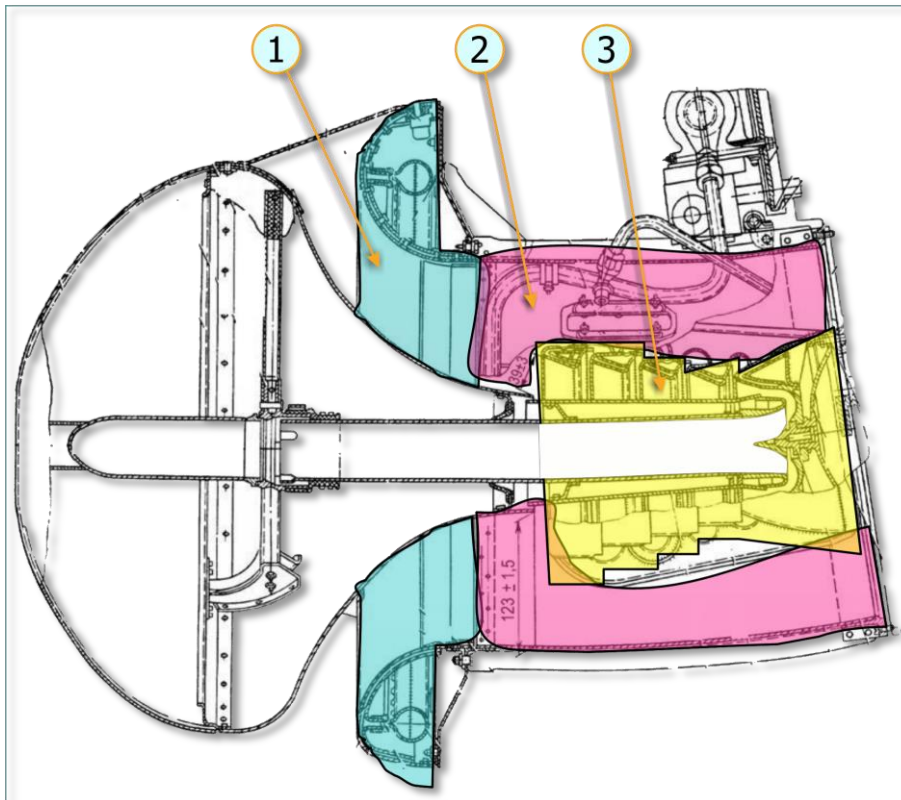

**Fig. 7.15. PSS parts heated by hot air**

- 1. Intake lip
- 2. Duct surface
- 3. PSS trap

Electrical heating ([Fig. 7.16](#)) is provided for the following units of PSS: fairing front and back, dust removal pipeline casing, dust exhaust throat and noses of fairing supports.

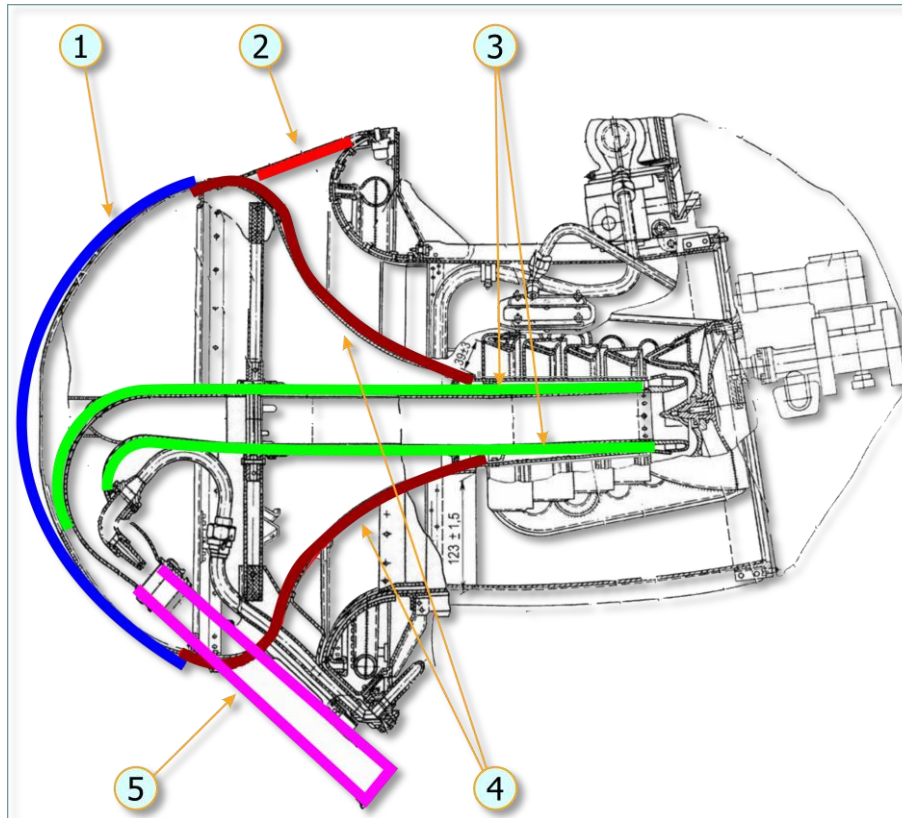

**Fig. 7.16. PSS parts heated by heating elements**

- |                            |                                 |
|----------------------------|---------------------------------|
| 1. Fairing front           | 3. Dust removal pipeline casing |
| 2. Nose of fairing support | 4. Fairing back                 |
|                            | 5. Dust exhaust throat          |

Heating pads are pasted on the entire area of the said surfaces (inside or outside). Between casing and heating pad, thermal sensors ТД-2 are pasted; those sensors ensure stable temperature of heater under various temperatures of outside air, along with temperature regulators ТЭР-1М.

Electric heating system is powered by 200 V AC, 400 Hz.

Heating of left engine, its air intake and PSS are energized and de-energized manually, heating of right engine and its inlet components are energized both manually and automatically from ice detector (see below). Heating is de-energized manually.

Readings of dashboard amperemeter ([Fig. 7.18](#)) shall be within 65-120 A. Current value depends upon simultaneous energizing of PSS front and back heating. To know true value of current, amperemeter readings should be divided by 3.

Technical details of heating elements:

Supply voltage, V	200-208V
Power demand, W, max.	8000
Current consumption, A, max.	40

### 7.4.4. Rotors Anti-Ice System

Blades of main and tail rotors are heated by heating elements powered by AC voltage.

Main rotor heating element comprises four sections, that of tail rotor is divided in two sections.

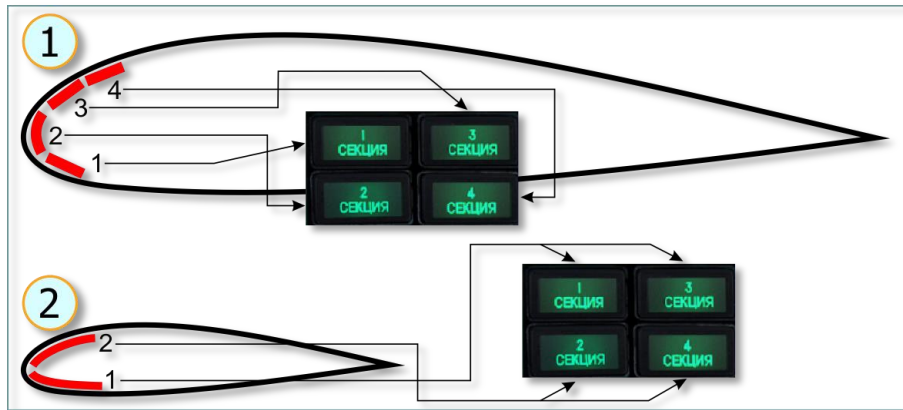

**Fig. 7.17. Main and Tail Rotors Blades Anti-Ice System. Diagram of Heating Elements Location Relative to Blade Profile**

1. Diagram of Main Rotor Heating Elements (4 sections)

2. Diagram of Tail Rotor Heating Elements (2 sections)

Sections are energized in cycles by cyclic timer ПМК-21. In one cycle, the cyclic timer activates heating of every section of main and tail rotors for 38.5 sec and cooling of them for 115.5 sec (main rotor section) and 38.5 sec (tail rotor section). Tail rotor heating elements sections are energized in the following sequence: the first sections of tail rotor blades' heating elements are energized along with the sections I and III of main rotor blades' heating elements; the second sections are energized along with the sections II and IV of main rotor blades' heating elements.

For check of current value in every section of every main rotor blade and in tail rotor sections, set rotary switch ТОКИ ПОТРЕБИТЕЛЕЙ (CONSUMERS CURRENTS) to positions ЛОПАСТИ НЕСУЩ. ВИНТА (MAIN ROTOR BLADES) 1-2-3-4-5 and ХВОСТ ВИНТА (TAIL ROTOR) in series when lamp of appropriate section comes on and check current in relevant sections of blades by dashboard amperemeter, [Fig. 7.18](#).





**Fig. 7.18. Check of Anti-Ice System Heating Elements Electric Circuits Operation**

1. Current consumers rotary switch
2. Lamp indicating energizing of separate sections of main rotor and tail rotor
3. AC amperemeter

Dashboard amperemeter should be within:

- 60-72 A for main rotor blade;
- 110-150 A for tail rotor blades.

To know true value of current, amperemeter readings are to be divided by 3 for main rotor blade and by 6 for tail rotor blades.

**7.4.5. Ice Detectors**

For timely detection of icing, warning about helicopter structures icing and automatic energizing of anti-icing system, helicopter is equipped with radioisotopic ice detector РИО-3 (RIO-3). Detecting unit of ice detector РИО-3 is installed in fan air intake duct. Operation is based on variation in conductivity of electric circuit section, which is energized by radioisotope beta-ray emission.



**Fig. 7.19. Radioisotopic Ice Detector**

Moreover, visual ice detector is fitted outside, on left land blister. Visual ice detector is a rod on the left sliding blister. The rod has red and black vertical stripes, 5 mm wide each. Pilot may use the rod to evaluate rate of icing (not implemented in the simulator).



**Fig. 7.20. Visual Ice Detector**



Radioisotopic ice detector serves for sending signal about initiation of icing to the crew (continuous warning signal when helicopter is in icing zone) and automatic energizing of anti-icing system (of both rotors, right engine and glasses). After helicopter leaves icing zone, ice detector РИО-3 stops generation of signal; anti-icing system is to be de-energized manually.

Signal from ice detector РИО-3 may be generated with certain delay if significant amount of ice is already accumulated on PSS and engine units. After heating is energized, accumulated ice may come off and get into engines, thus causing failure of engines.

To avoid this, heating of PSS and engines is to be energized manually before flight.

#### 7.4.6. Control of Anti-Ice System

1. For anti-ice system functioning in manual and automatic modes, anti-ice system

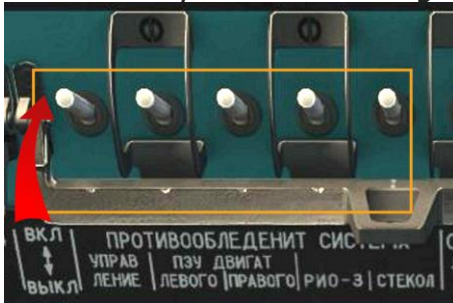

CB should be on.

2. The control of anti-ice system is carried out using the anti-ice system Control Panel, [Fig. 7.21](#)



**Fig. 7.21. Anti-Ice System Control Panel**

- |   |  |
|---|--|
| <ol style="list-style-type: none"> <li>1. Switch ОБЩЕЕ РУЧН-АВТОМ (GENERAL MANUAL-AUTO)</li> <li>2. Anti-ice system disabling button</li> <li>3. Switch ДВИГ ПЗУ ЛЕВ (ENG PSS LEFT) for PSS and left engine inlet heating</li> <li>4. Icing indicator lamp (red) and anti-ice system activation indicator lamp (green)</li> <li>5. Indicator lamp of PSS and left (left side) and right (right side) engines' inlets heating activated</li> <li>6. Rotary switch, for consumers current monitoring</li> </ol> | <ol style="list-style-type: none"> <li>7. Switch (manual – automatic activation) ДВИГ ПЗУ ПРАВ (ENG PSS RIGHT) for PSS and right engine inlet heating</li> <li>8. Monitoring of detector РИО-3 heating</li> <li>9. Switch of detector РИО-3 heating</li> <li>10. Glasses heating switch</li> <li>11. Detector РИО-3 heating serviceability indicator lamp</li> <li>12. AC amperemeter</li> <li>13. Lamp indicating successive activation of main and tail rotors' separate sections</li> </ol> |
|---|--|

3. For anti-icing system operation **in automatic mode**, all switches on the control



panel should be in lower position:

Operation in automatic mode is based on receiving a signal from ice detector РИО-3 by anti-ice system control unit. At that, under icing conditions, anti-ice system and warning system generates the following signals:



- for ОБЛЕДЕН (ICING) lamp coming on;
- for automatic energizing of anti-icing system of rotors blades, right engine, its air intake, PSS and glass heating – the same may be verified by appropriate lamps coming on



- for replay of РИ-65 (RI-65) voice recorder message: ОБЛЕДЕНЕНИЕ (ICING);
- to the САПП-12ДМ (SARPP-12DM) flight data recorder, for producing signal ОБЛЕДЕН (ICING).

If anti-ice system was energized automatically, energize anti-ice system of PSS and LEFT engine inlet manually (set switch ДВИГ ПЗУ ЛЕВ (LEFT ENG PSS) to top position), after you make sure in stable operation of right engine.

4. For anti-icing system operation **in manual mode**, all switches on the control panel should be in upper position (except РИО-3 switch):

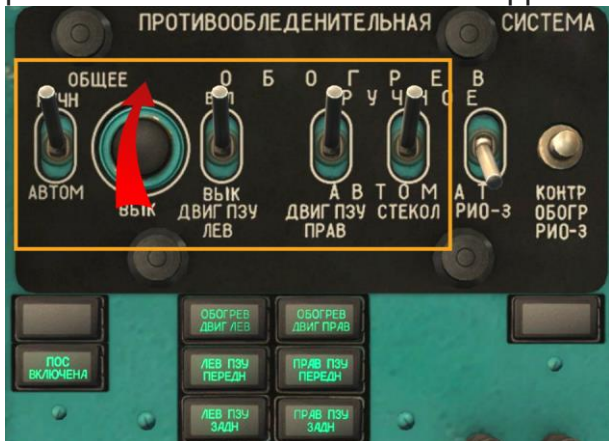

Moreover, manual energizing of anti-ice system for separate units is possible: main rotor and tail rotor; left engine (PSS and engine inlet); right engine (PSS and engine inlet); glasses.

5. To de-energize anti-ice system, set all anti-ice system switches to off (down) on

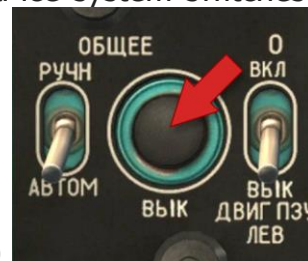

the control panel and press button ВbК (OFF)

#### 7.4.7. The effect of Anti-Ice System system on the flight characteristics

##### *Maximum takeoff weight*

With PZU (PSS) turned on, reduce maximum takeoff weight indicated in charts Fig. 8.1 , [Fig. 8.2](#) Fig. 8.3 by 200 kg. With engine and rotor anti-ice systems turned on, reduce maximum takeoff weight indicated in this charts by 1000 kg.

##### *Fuel consumption*

With anti-ice system engaged, fuel consumption rates indicated in the tables [Table 8.4](#) increase as follows:

- engine anti-ice system: 3%
- main and tail rotor anti-ice system: 2%

With the PZU (PSS) engaged, fuel consumption rates per hour provided in [Table 8.4](#) increase by 3%.

#### 7.5. Pneumatic System

Helicopter pneumatic system serves for breaking of main landing gear wheels and charging of wheels tubes from on-board bottles when helicopter is not on an airfield ([Fig. 7.22](#)).

Compressed air under pressure 50 kgf/cm<sup>2</sup> is stored in bottles enclosed in main landing gears brace struts.

Bottles are charged from compressor driven from main gear when engine is running, or from ground bottle via charging connection.

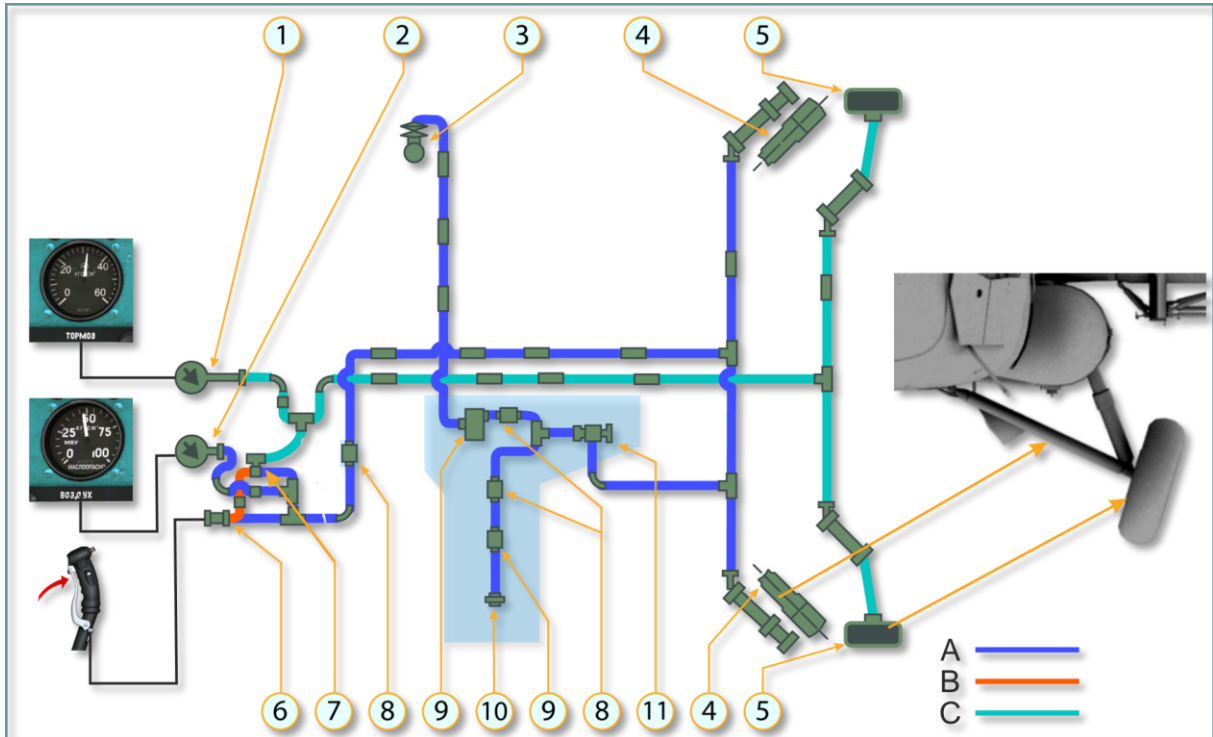

**Fig. 7.22. Pneumatic System Diagram**

- |                                 |   |
|---------------------------------|---|
| 1. Pressure gauge MA-60K        | 8. Check valve 636100M                  |
| 2. Pressure gauge HTM-60        | 9. Filter                               |
| 3. Compressor AK-50T,           | 9. Filter                               |
| 4. Bottles                      | 10. Charging valve 3509c50              |
| 5. Wheel break                  | 11. Pressure control unit АД-50         |
| 6. Reducing valve УП-25/2       | A – pressure 40..54 kgf/cm <sup>2</sup> |
| 7. Reducing accelerator УПО3/2М | B – pressure 0..14 kgf/cm <sup>2</sup>  |
|                                 | C – pressure 30..34 kgf/cm <sup>2</sup> |

(1) *PRESSURE GAUGE MA-60K* serves for breaks pressure monitoring;

(2) *PRESSURE GAUGE HTM-60* serves for bottles pressure monitoring (4);





**Fig. 7.23. Pressure gauges of Pneumatic System**

1. Pressure gauge HTM-60 (NTM-60)                      2. Pressure gauge MA-60K (MA-60K)

(3) *AIR COMPRESSOR AK-50T (AK-50T)* serves for re-charging of helicopter pneumatic system with compressed air during flight. Compressor provides for charging of on-board bottles with air to pressure  $(5000+400)$  kPa  $[(50+4)$  kgf/cm<sup>2</sup>] within no more than 25 min. Air compressor AK-50T is driven from main gear.

(4) *BOTTLES*. Bottles are formed by internal cavities of main landing gears brace struts.

(5) *WHEEL BRAKE* is of drum type; for breaking, air presses pads to the drum.

(6) *REDUCING VALVE УП25/2 (UP25/2)* controls breaks of main landing gears' wheels pneumatically. Control is effected by lever on cyclic pitch control stick, [Fig. 7.24](#).

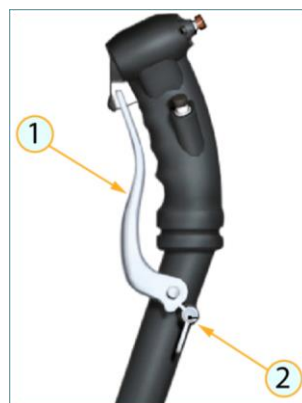

**Fig. 7.24. Wheel Break Lever on Left Cyclic Pitch Control Stick**

 1. Breaks control lever **[W]**

 2. Parking break trigger **[LShift +W]**

(7) *REDUCING ACCELERATOR УПО3/2М (UPO3/2M)* accelerates compressed air feed to main gears wheels breaks; also, it ensures air bleed to atmosphere during breaks release. Reducing accelerator operates from pilot pressure fed from reducing valve УП25/2; the accelerator creates pressure of (3300+300) kPa [(33+3) kgf/cm<sup>2</sup>] in break line.

(11) *PRESSURE CONTROL UNIT АД-50 (AD-50)* switches over modes of AK-50T compressor operation (operating mode to idle mode and vice versa), automatically. Compressor is switched from operating to idle mode under air bottles pressure (5000+400) kPa [(50+4) kgf/cm<sup>2</sup>], and from idle to operating mode under pressure not less than 4000 kPa (40 kgf/cm<sup>2</sup>). Pressure control unit is installed on the pneumatic units' panel.

NOTE. Pneumatic units' panel facilitates units installation and tightness check; also, it allows to reduce number of pipes. It accommodates some pneumatic system units. The panel is located in fuselage cargo compartment, left side.

#### Primary technical details of pneumatic system:

Parameter Description	Minimum Value	Nominal Value	Maximum Value
Bottles air pressure, kgf/cm <sup>2</sup>	40	50	54
Wheel breaks air pressure, kgf/cm <sup>2</sup>	30	32	34

### ***Normal Operation***

Check charging of air system (system pressure read by pressure gauge ВОЗДУХ (AIR) should be 40...50 kg/cm<sup>2</sup>) and operation of landing gear wheels break system (when break lever is pressed, wheel breaks pressure read by pressure gauge ТОРМОЗ (BREAK) should be 30...34 kgf/cm<sup>2</sup>; after brake release, no residual pressure in breaks is allowed).

## ***7.6. Fire Protection System***

### **7.6.1. Brief Description**

Fire protection equipment serves for fire detection, indication and extinguishing in the protected units. The helicopter fire protection equipment comprises fire detection and alarm system and fire extinguishing system that includes two ballons with fire-extinguishing liquid (one ballon is the first order operation; another is the second order operation). After СИГНАЛИЗАЦИЯ (INDICATION), 1 ОЧЕРЕДЬ (THE FIRST ORDER), 2 ОЧЕРЕДЬ (THE SECOND ORDER) breakers are switched on, electric circuit is powered by battery bus, [Fig. 7.25](#):



Fig. 7.25. Fire Protection System circuit breakers

### 7.6.2. Fire detection and alarm system

ССП-ФК (SSP-FK) fire indication system serves for fire indication and crew warning.

The ССП-ФК (SSP-FK) fire indication system serves for:

- fire indication in the helicopter protected units
- crew warning by light alarm
- producing for additional signals on the voice data and flight variables auto-recording equipment
- automatic energizing of the first order ballon discharging in the unit where fire signal was detected
- indication of fire-extinguishing equipment operation
- monitoring of system serviceability and alertness.

The ССП-ФК (SSP-FK) equipment operation is based on receiving and processing electrical signal from the special detecting units. This unit is a thermopile. It assembles of three alternately connected chromel-alumel thermocouples. Electrodes hot junctions (fast-response) are much lesser size than non-operating (slow-response) ones. When the unit environment heating fast, its fast-response junctions heat much faster than slow-response ones as fast-response junctions are lesser mass. Due to the difference of hot and non-operating junctions heating temperatures, thermal electromotive force appears on the unit output rod.

#### ***Fire detection system***

There is three sets of the ССП-ФК (SSP-FK) equipment on the helicopter. They serves for fire detection in four units that are more dangerous in relation of fire hazard. These units are as follows:

- the left engine
- the right engine
- KO-50 kerosene-combustion heater
- the main rotor transmission, the fuel consumed tank and the AI-9B (AI-9V) engine (these three sections are included into one protected unit).

Fire detection system operates on a multiple-circuit electric device. It is equipped with some standalone sensor groups, which initiate signals on actuation devices, in each monitored unit.

In the actuating unit, each sensor group is connected to its signal conditioner (combined unit) forming a fully independent sensitive circuit. Thereby, it is ensured high system reliability, as in case of any

sensor group failure, normal operation of the other sensor groups stays constant. The system is able to detect a fire by one circuit of sensitive elements.

The ССП-ФК (SSP-FK) system comprises the following:

- 42 FAS (fire-alarm sensor) signal devices type integrated into 14 groups.

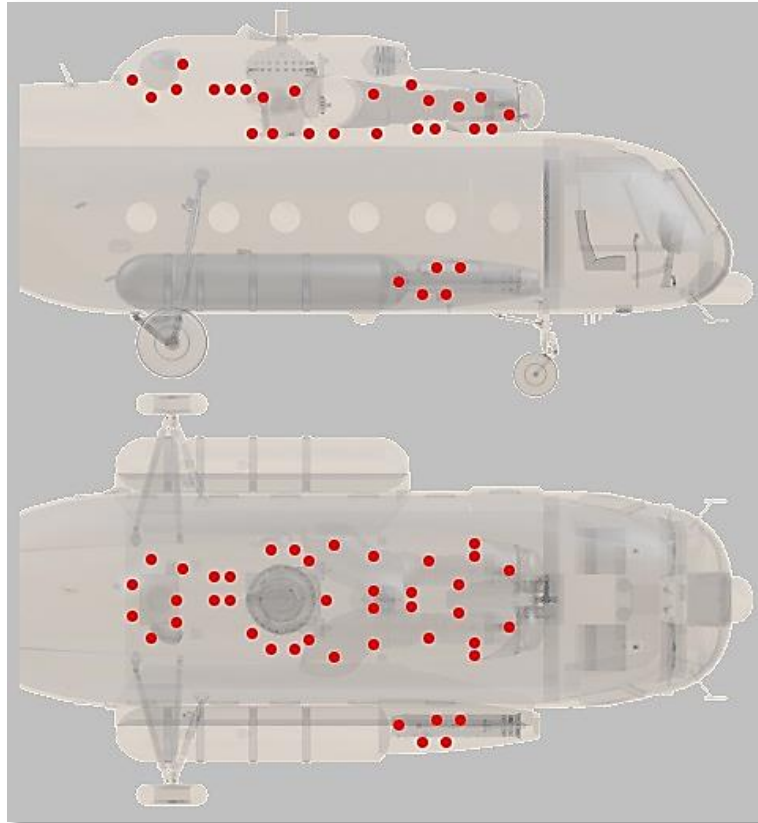

**Fig. 7.26. Location of the ССП-ФК (SSP-FK) system sensors**

- three ССП-ФК-БИ (SSP-FK-BI) actuating units, which receive electric signals initiating in sensors circuit in event of fire and control indication system and automatic equipment. The actuating units are installed in the cockpit on the right rack.

### ***Fire alarm system***

**Light alarm.** Fire light alarm system comprises five indicating lamps with red filters installed on the fire protection system switchboard, [Fig. 7.27](#), 1:

- Two ПОЖАР ЛЕВ. ДВ. (LEFT ENGINE FIRE) and ПОЖАР ПРАВ. ДВ. (RIGHT ENGINE FIRE) lamps indicate about a fire in the helicopter left and right engine units
- ПОЖАР КО-50 (KO-50 FIRE) lamp indicates about a fire in the KO-50 kerosene-combustion heater unit
- ПОЖАР РЕДУК. АИ-9 (ROTOR TRANSMISSION FIRE AI-9) lamp indicates about a fire in the units of the main rotor transmission, the fuel consumed tank and the АИ-9В (AI-9V) engine
- ПОЖАР (FIRE) lamp is an additional lamp on the left dashboard which duplicates any of four main lamps coming on, [Fig. 7.28](#).



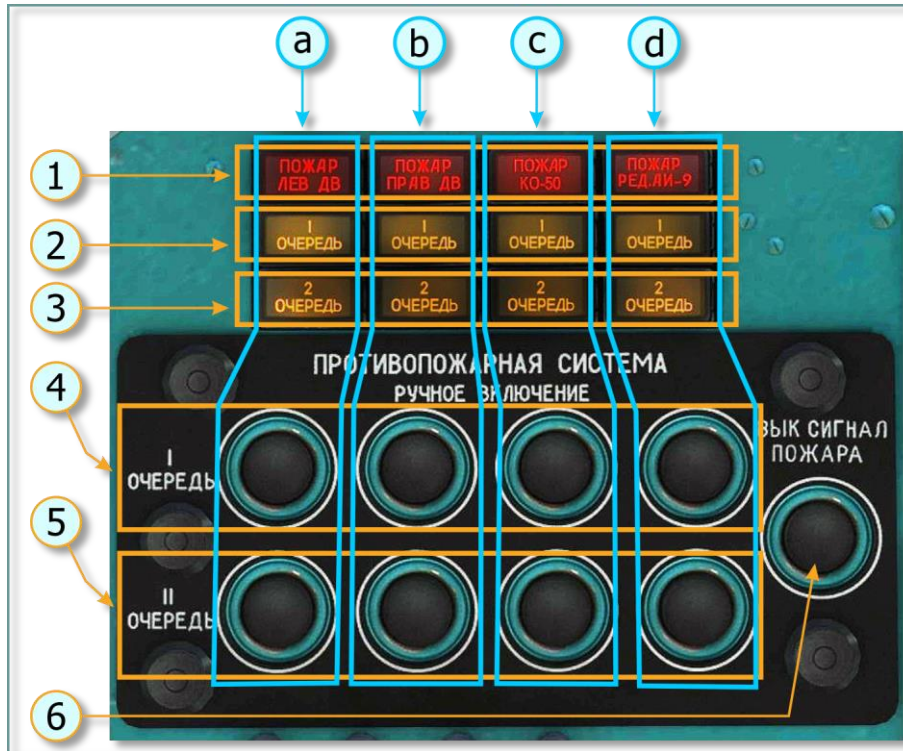

**Fig. 7.27. Fire protection system switchboard on Center overhead console**

1. The lamp indicating fire in the protected units (ПОЖАР ЛЕВ ДВ, ПОЖАР ПРАВ ДВ, ПОЖАР КО-50, ПОЖАР РЕД.АИ-9) (LEFT ENGINE FIRE, RIGHT ENGINE FIRE, KO-50 FIRE, MAIN ROTOR AI-9 FIRE)
2. The lamp indicating operation of the first order fire extinguishing system
3. The lamp indicating operation of the second order fire extinguishing system
4. The first order fire extinguishing system push button
5. The second order fire extinguishing system push button
6. Alarm silence push button

Letters mark lamps indicating fire, operation of fire extinguishing system ballons and push buttons of units fire protection system as follows:

- a. The LEFT engine
- b. The RIGHT engine
- c. The KO-50 kerosene-combustion heater
- d. The main rotor transmission, the fuel consumed tank and APU



**Fig. 7.28. Lamp ПОЖАР (FIRE) on the left dashboard**



To capture the crew attention to fire alert in any unit as soon as possible, it is provided for operation these five indication lamps in flashing mode. For this purpose, its supply circuits are connected into the helicopter FLASHER (МИГАЛКА) system scheme.

**Auxiliary alarm signal.** Simultaneously with energizing the lamp, fire protection system serves for sending auxiliary alarm signals by parallel circuit in the unit input in the РИ-65 (RI-65) voice data equipment kit. Depending on the site of the fire, a signal comes on one of the four channels, which herewith energizing and serves for replay of the РИ-65 (RI-65) voice recorder message to the left pilot's phones: ПОЖАР ЛЕВЫЙ ДВИГАТЕЛЬ, ПОЖАР ПРАВЫЙ ДВИГАТЕЛЬ, ПОЖАР РЕДУКТОР ВСУ, ПОЖАР КО-50 (LEFT ENGINE FIRE, RIGHT ENGINE FIRE, ROTOR TRANSMISSION APS FIRE, KO-50 FIRE).

The voice recorder message comes to the left pilot's phones repeatedly and replays on a periodic basis of two messages per 12 s. Simultaneously, the same message is sent to the flight ground control station and the **unit input in the** flight variables auto-recording equipment (САПП-12ДМ (SARPP-12DM)) via the helicopter command communication VHF radio.

### 7.6.3. Indication and alarm system check

Indication and alarm system serviceability are monitored by checking of the indicating lamps and monitoring of the sensors serviceability.

*LAMPS SERVICEABILITY* and its power supply circuits are checked by the helicopter lamps check system with the ПРОВЕРКА ЛАМП. МИГАЛКА (LAMP CHECK. FLASHER) circuit breaker and the МИГАЛКА (FLASHER) switch set to on.

When setting the ПРОВЕРКА МИГАЛКИ-СИГНАЛ. ЛАМП switch on the pilot's central console to the ПРОВЕРКА МИГАЛКИ (FLASHER CHECK) position, five fire indication lamps should come on in flashing mode ([Fig. 7.27](#), 1 и [Fig. 7.28](#)). When setting the ПРОВЕРКА СИГНАЛ. ЛАМП switch on, eight 1 ОЧЕРЕДЬ (1 ORDER) and 2 ОЧЕРЕДЬ (2 ORDER) lamps should come on ([Fig. 7.27](#), 2, 3).

*FAS SIGNAL DEVICES SERVICEABILITY* and its power supply circuits are monitored by the КОНТРОЛЬ ДАТЧИКОВ (MONITORING OF SIGNAL DEVICES) panel ([Fig. 7.29](#)) on the mid section of electric panel after the ОГНЕТУШЕНИЕ-КОНТРОЛЬ ДАТЧИКОВ (FIRE EXTINGUISHING - MONITORING OF SIGNAL DEVICES) switch set to the КОНТРОЛЬ ДАТЧИКОВ (MONITORING OF SIGNAL DEVICES) position. Herewith, КОНТРОЛЬ ДАТЧИКОВ (MONITORING OF SIGNAL DEVICES) red indicator lamp ([Fig. 7.29](#), 3) comes on, indicating monitoring circuit readiness



**Fig. 7.29. КОНТРОЛЬ ДАТЧИКОВ (MONITORING OF SIGNAL DEVICES)**  
Center overhead console

- |   |   |
|---|---|
| <p>1. ОГНЕТУШЕНИЕ – КОНТРОЛЬ ДАТЧИКОВ (FIRE EXTINGUISHING - MONITORING OF SIGNAL DEVICES) switch</p> <p>2. Switch I – II checking of pyros on fire-extinguishing liquid ballons</p> <p>3. Lamp indicating position of switch (1) КОНТРОЛЬ ДАТЧИКОВ (MONITORING OF SIGNAL DEVICES)</p> | <p>4. ВЫК – КОНТРОЛЬ – КАНАЛЫ (OFF – MONITORING – CHANNELS)1–2–3–4–5–6 switch</p> <p>5. Positions for connection of signal devices channels 1–2–3–4–5–6 or monitoring shutting down (ВЫК (OFF))</p> |
|---|---|

Monitoring system is operated by battery bus via ПРОТИВОПОЖАРНАЯ СИСТЕМА. СИГНАЛИЗАЦ. (FIRE PROTECTION SYSTEM. INDICATION) circuit breaker and КОНТРОЛЬ ДАТЧИКОВ (MONITORING OF SIGNAL DEVICES) rotary switch. Fourteen groups of FAS signal devices are integrated into six monitoring channels (Fig. 7.29, 4). Each of them connected to its switch contact. For monitoring, each switch is required to set to checking channels position alternately. In case of serviceability of signal devices in the groups and its power supply circuits, on the mid section of the electric panel and the left dashboard, appropriate lamps, indicating fire, should come on (Fig. 7.27, 1 и Fig. 7.28).

Division of the groups of the different units signal devices for monitoring channels is given in the table:

Monitored units	Monitoring channels						Lamps come on
	I	II	III	IV	V	VI	
Left engine	+	+	+				ПОЖАР ЛЕВ. ДВ. (LEFT ENGINE FIRE)
Right engine	+	+	+				ПОЖАР ПРАВ ДВ. (RIGHT ENGINE FIRE)
Main rotor transmission, Service fuel cell	+	+	+	+			ПОЖАР РЕДУК. АИ-9 (MAIN ROTOR АИ-9 (AI-9) FIRE)
АИ-9В (АИ-9V) engine					+	+	ПОЖАР РЕДУК. АИ-9 (MAIN ROTOR АИ-9 (AI-9) FIRE)

KO-50 Kerosene-combustion heater	+	+					ПОЖАР КО-50 (KO-50 FIRE)
----------------------------------	---	---	--	--	--	--	--------------------------

#### 7.6.4. Fire extinguishing system

Fixed fire extinguishing system comprises two УБШ-4-4 (UBSH-4-4) type ball shaped ballons with extinguishing agent served for two orders discharging, [Fig. 7.30](#). The ballon is charged extinguishing agent comprised of Freon gas 114B<sub>2</sub> weighing 5,640 kg and, for providing this agent supply, it is charged air mixture or nitrogen weighing 0,180 kg to the pressure (10500...11500) kPa [(105...115) kgf/cm<sup>2</sup>] at a temperature of 15...20 °C. Each ballon is equipped with four initiators (as per the number of protected units). Each initiator is opened by two pyros. Ballons are located in the unit of the main rotor transmission on the starboard side.

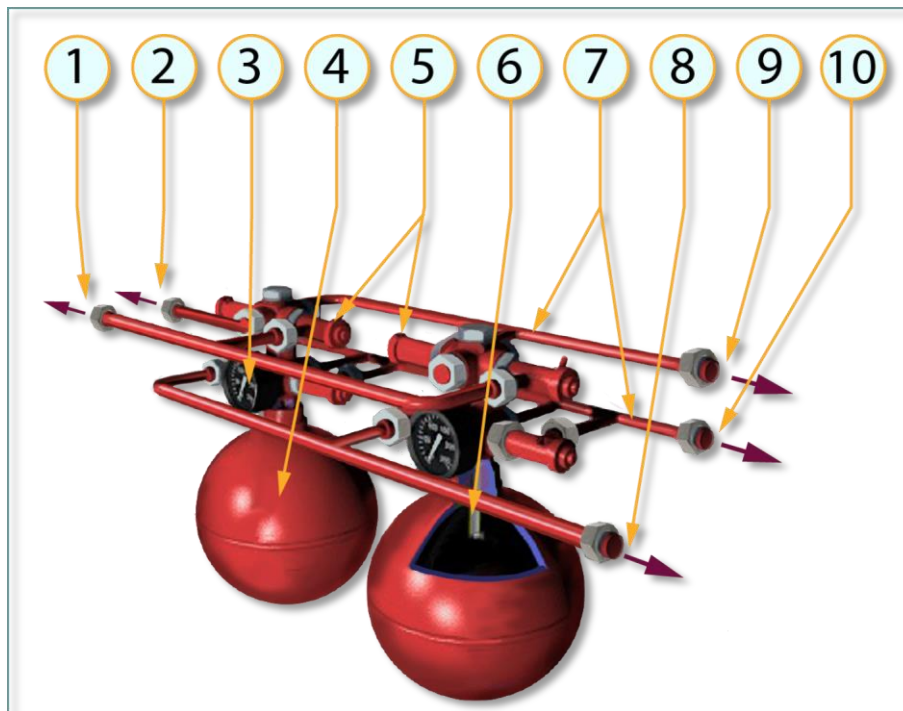

**Fig. 7.30. УБШ-4-4 (UBSH-4-4) Fire extinguisher**

- |  |  |
|--|--|
| 1. Branch pipe to the unit of main rotor transmission, the fuel consumed tank and AI-9B (AI-9V) engine | 5. ПГКц (PGKts) Initiator                |
| 2. Branch pipe outboard  | 6. Siphon tube                           |
| 3. Pressure gauge  | 7. Collector component                   |
| 4. УБШ-4-4 (UBSH-4-4) Fire extinguisher ballon, collector component                                    | 8. Branch pipe to the KO-50 unit         |
|  | 9. Branch pipe to the left engine unit   |
|  | 10. Branch pipe to the right engine unit |

Please note, that during fire extinguishing in the unit of the main rotor transmission, the fuel consumed tank and the AI-9B (AI-9V) engine, extinguishing agent spreads through three protected sections (the section of the main rotor transmission, the section of the fuel consumed tank as well as the section of the AI-9B (AI-9V) engine), in spite of there was a fire in the section of the fuel consumed tank (for example).

## 7.6.5. Normal Operation

### *Operating Conditions (stages) and required actions*

#### 1. CHECK OF SERVICEABILITY OF ELECTRICAL POWER SYSTEM FIRE PROTECTION EQUIPMENT.

After energizing the electrical power sources, it is required to:

- set the РАДИО (RADIO) breaker to off ;
- set the ПРОТИВОПОЖАРНАЯ СИСТЕМА (FIRE PROTECTION SYSTEM)



- set the КОНТРОЛЬ ПИРОПАТРОНОВ (PYROS MONITORING) switch to the

positions I and II alternately , make sure that pyros electric circuits are serviceable (no yellow fire extinguisher indicator lamps should come



- set the КОНТРОЛЬ ДАТЧИКОВ-ОГНЕТУШЕНИЕ (MONITORING OF SIGNAL DEVICES - FIRE EXTINGUISHING) switch to the КОНТРОЛЬ

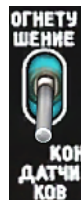

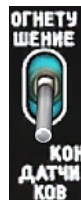
(MONITORING) position . At that, the КОНТРОЛЬ ДАТЧИКОВ (MONITORING OF SIGNAL DEVICES) indicator lamp should come on

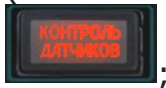

- set the rotary switch to positions of six channels alternately



When setting the switch to positions 1 and 2, the following lamps should come on: ПОЖАР ЛЕВ. ДВ. (LEFT ENGINE FIRE), ПОЖАР ПРАВ. ДВ. (RIGHT ENGINE FIRE), ПОЖАР КО-50 (КО-50 FIRE), ПОЖАР РЕДУК. АИ-9 (ROTOR TRANSMISSION АИ-9

(AI-9) FIRE)



. When setting the switch to the position 3, the КО-50 fire indicator lamp should go off. When setting the switch to the positions 4, 5 and 6, the ПОЖАР РЕДУК.АИ-9 (ROTOR TRANSMISSION AI-9 (AI-9) FIRE) indicator lamp should come on, another lamps should go off.

## 2. SYSTEM PREPARATION FOR WORK



- set the rotary switch to the ВЫК (OFF) position;
- set the КОНТРОЛЬ ДАТЧИКОВ-ОГНЕТУШЕНИЕ (MONITORING OF SIGNAL DEVICES - FIRE EXTINGUISHING) switch to the ОГНЕТУШЕНИЕ

(FIRE EXTINGUISHING) position . At that, the КОНТРОЛЬ ДАТЧИКОВ (MONITORING OF SIGNAL DEVICES) indicator lamp should go



off

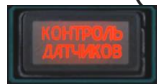

- The system is ready to automatic operation or manual actuation.

## 3. SWITCHING THE SYSTEM OFF

After taxiing in and shutting down the engines, for switching the system off, set the ПРОТИВОПОЖАРНАЯ СИСТЕМА (FIRE PROTECTION SYSTEM) breaker to off.

**WARNING.** To avoid operating of the first (automatic) order fire extinguishers of the system, do not set the rotor switch from the ВЫКЛ (OFF) position if the КОНТРОЛЬ ДАТЧИКОВ-ОГНЕТУШЕНИЕ (MONITORING OF SIGNAL DEVICES - FIRE EXTINGUISHING) switch is in the position ОГНЕТУШЕНИЕ (FIRE EXTINGUISHING), and do not set the КОНТРОЛЬ ДАТЧИКОВ-ОГНЕТУШЕНИЕ (MONITORING OF SIGNAL DEVICES - FIRE EXTINGUISHING) switch to the ОГНЕТУШЕНИЕ (FIRE EXTINGUISHING) position before the rotor switch is set to the ВЫКЛ (OFF) position.

### ***The system operation and crew procedure with fire protection equipment in case of fire***

If there is any protected units fire (for example, the left engine fire) and thermal electromotive force on any signal devices channels, the following lamps come on:

- the ПОЖАР ЛЕВ ДВ (LEFT ENGINE FIRE) lamp on the fire protection system switchboard ([Fig. 7.27, 1-a](#));
- the ПОЖАР (FIRE) lamp on the left dashboard ([Fig. 7.28](#)).

Simultaneously, pyro of extinguishing liquid supply line of the first order ballon detonates. At that, the 1 ОЧЕРЕДЬ (1 ORDER) indicator lamp of the first order operation on the fire protection system switchboard comes on ([Fig. 7.27, 2-a](#)).



When fire is extinguished, during not more than 10 s, thermal electromotive force on any signal devices channels disappears and the ПОЖАР ЛЕВ ДВ (LEFT ENGINE FIRE) lamp goes off, but the 1 ОЧЕРЕДЬ (1 ORDER) lamp continues to come on. When the lamps do not go off in 10 s, press the ВыК. СИГНАЛИЗАЦИИ ПОЖАРА (ALARM SILENCE PUSH BUTTON) button ([Fig. 7.27](#), 6).

When the first order ballon is not operated automatically, the ПОЖАР ЛЕВ ДВ (LEFT ENGINE FIRE) lamp on the fire protection system switchboard and the ПОЖАР (FIRE) lamp on the left dashboard come on, but the 1 ОЧЕРЕДЬ (1 ORDER) lamp does not come on), it is required to detonate the pyro of extinguishing liquid supply line to the left engine unit of the first order ballon manually by pressing the 1 ОЧЕРЕДЬ (1 ORDER) button for the left engine unit ([Fig. 7.27](#), 4-a).

When the left engine fire is extinguished by the first order ballon, and then there is another unit fire (for example, the unit of the main rotor transmission, the fuel consumed tank and APS (auxiliary power supply)), that is required to detonate the pyro of the second order ballon manually by pressing the 2 ОЧЕРЕДЬ (2 ORDER) button for the unit of the main rotor transmission, the fuel consumed tank and APS ([Fig. 7.27](#), 5-d). After that, the 2 ОЧЕРЕДЬ (2 ORDER) lamp, located under the ПОЖАР РЕД.АИ-9 (ROTOR TRANSMISSION АИ-9 FIRE) lamp on the fire protection system switchboard, comes on ([Fig. 7.27](#), 3-d).

NOTE. After fire extinguishing system operating in the unit of the main rotor transmission, the fuel consumed tank and APS operates, the АИ-9В (АИ-9V) engine shuts down, if it operates, and its start is blocked. That is similar to the KO-50 unit.

See also [Onboard fire](#)

## ***7.7. Environmental and heating system***

### **7.7.1. Brief description**

The environmental and heating system is used for creating and maintaining comfortable environmental conditions for crew and passengers. It provides:

- supply of heated and atmospheric air to the cockpit and cargo cabin;
- airflow for blowing on front windshields and cockpit blisters.

This system consists of the KO-50 combustion heater and two DV-302T cockpit fans for right and left pilot.

The heater is operating in the following way: after heater was started, in the combustion camera the kerosene-air mixture is being burned and exhaust gas is being removed through the exhaust nozzle. Heat from the combustion, is warming up the calorifer. The airflow from a fan is moving through calorifer, air is being warmed up and fed to the helicopter's cockpit.

The heater can operate either in automatic, manual or ventilation mode. When heater is operating in automatic mode, the temperature, set by the temperature knob, is being maintained constant. Manual control is used for maximum or medium heating output modes. The recirculation mode is used to speed up the heating of the cabins during winter conditions, by using air from the cargo cabin. In the game, this

behavior of shut-dumper is not modelled. In the ventilation mode, this system provides cooling of the heater and cabins ventilation (through air ducts) during warmer seasons.

In the electrical circuit of the heater, the relay, which disconnects electrical power supply in case of a fire in the KO-50 bay, is installed.

The KO-50 heater is located in front of the right external fuel tank, [Fig. 7.31](#):

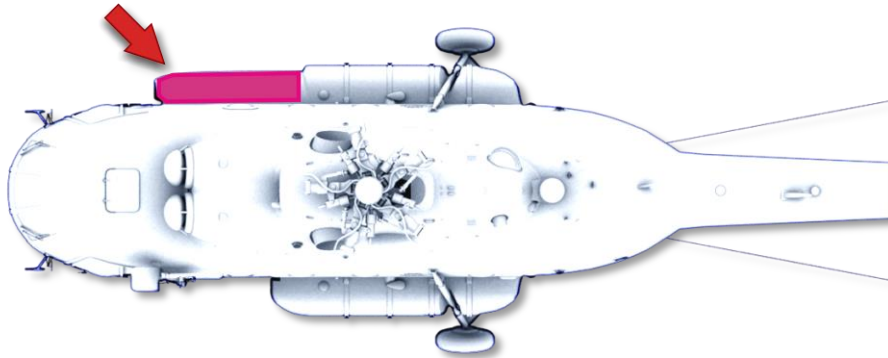

**Fig. 7.31. Location of the KO-50 heater on the helicopter**

Heat output of the KO-50 heater is equal to 50,000 kcal/h, in case of temperature difference on the ground of 130°C. Air consumption is 1,760 kg/h, if pressure behind the heater is 100 mm H<sub>2</sub>O. Fuel consumption is 8.7 kg/h. Electrical power consumption of the fan is 2.5 kW.

Fuel for the heater is supplied from the right engine's fuel pipes, when the 610200A KO-50 electro-magnetic valve is opened. This valve is opened by the heater starter system, from the KO-50 control panel, [Fig. 7.32](#).

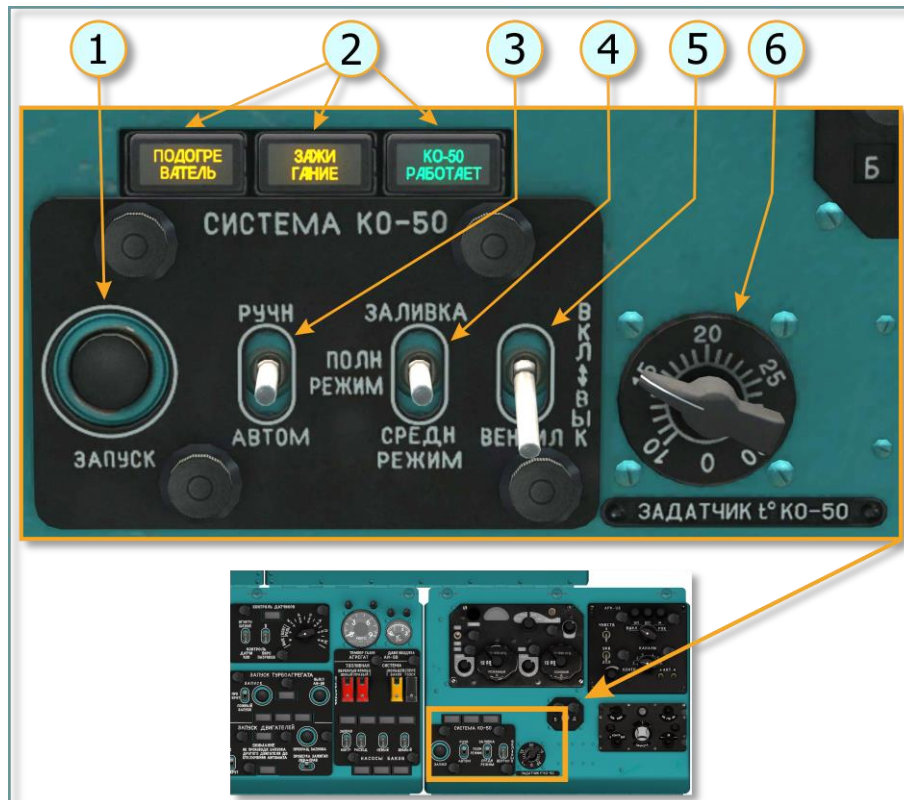

**Fig. 7.32. KO-50 control panel**

1. KO-50 start button
2. KO-50 status panel:
  - ПОДОГРЕВАТЕЛЬ (PREHEATER) – indicates engagement of the fuel preheater;
  - ЗАЖИГАНИЕ (IGNITION) – indicates operation of the igniter;
  - КО-50 РАБОТАЕТ – KO-50 IS OPERATING
3. РУЧН – (НЕЙТРАЛЬ) – АВТОМ (MANUAL – NEUTRAL –AUTO ) KO-50 modes switch
4. The ЗАЛИВКА – ПОЛН РЕЖИМ – СРЕДН РЕЖИМ (PRIME-HIGH-MEDIUM OUTPUT MODE):
  - ПОЛН РЕЖИМ – СРЕДН РЕЖИМ (HIGH –MEDIUM MODE) positions are used for setting high and medium heat output modes correspondingly, when operating in manual mode;
  - ЗАЛИВКА (PRIME) position is used for system maintenance and not modelled in this game.
5. Fan switch
6. Temperature knob

### 7.7.2. Enabling the KO-50 heater in automatic mode

- Enable the KO-50 ACB on the right over head circuit breaker panel



- set the mode switch on the heater control panel into the АВТОМ. (AUTOMATIC) position (Fig. 7.32, 3);
- set required temperature by the temperature knob (Fig. 7.32, 6);
- press the ЗАПУСК (START) button (Fig. 7.32, 1), as a result on the heater control panel the ПОДОГРЕВАТЕЛЬ (PREHEATER) signal panel goes on. When fuel temperature reaches  $70\pm 5^{\circ}\text{C}$ , the ПОДОГРЕВАТЕЛЬ (PREHEATER) panel goes off and the ЗАЖИГАНИЕ (IGNITION) and КО-50 РАБОТАЕТ (KO-50 IS OPERATING) lights are on. After not more than 40 seconds, the ЗАЖИГАНИЕ (IGNITION) panel should go off, this will indicate sustainable combustion of the fuel in the KO-50 heater.

### 7.7.3. Enabling the KO-50 heater in manual mode

- Enable the KO-50 ACB on the right over head circuit breaker panel panel;
- set the mode switch on the KO-50 control panel to the РУЧН (MANUAL) position;
- set the heat output mode switch to the ПОЛН.РЕЖИМ (HIGH OUTPUT) or СРЕДН.РЕЖИМ (MEDIUM OUTPUT) position;
- press the ЗАПУСК (START) button.

The following stages of operation are equal to those in automatic mode.

NOTE: Before disabling the heater, to cool it faster, set the ВЕНТИЛ. (VENTILATION) switch to the ВКЛ. (ENABLE) position for 3..10 minutes (no need to use it in game).

### 7.7.4. Using the KO-50 heater in ventilation mode

When the heater is supposed to be used during summer time for cabins ventilation, enable the KO-50 ACB and set the ВЕНТИЛ. (VENTILATION) switch to the ВКЛ. (ENABLE) position. Air is supplied, using the same air channels as during winter time.

### 7.7.5. Switching OFF the KO-50 heater

- Set the РУЧН.- АВТОМ. (MANUAL-AUTO) switch into the neutral position;
- after landing, disable corresponding ACB.

## 7.8. Lighting equipment

The helicopter is equipped with lighting equipment, which supposed to be used during day and night flights. Lighting equipment includes exterior and interior lighting equipment.

### 7.8.1. Exterior lighting equipment

Exterior lighting equipment consists of, [Fig. 7.33](#):

- two FPP-7M search/landing lights;
- FR-100 taxi light;
- MSL-3 anti-collision light;
- BANO-45 navigation lights and the KhS-39 tail light;
- OPS-57 formation lights;
- blade tip lights.

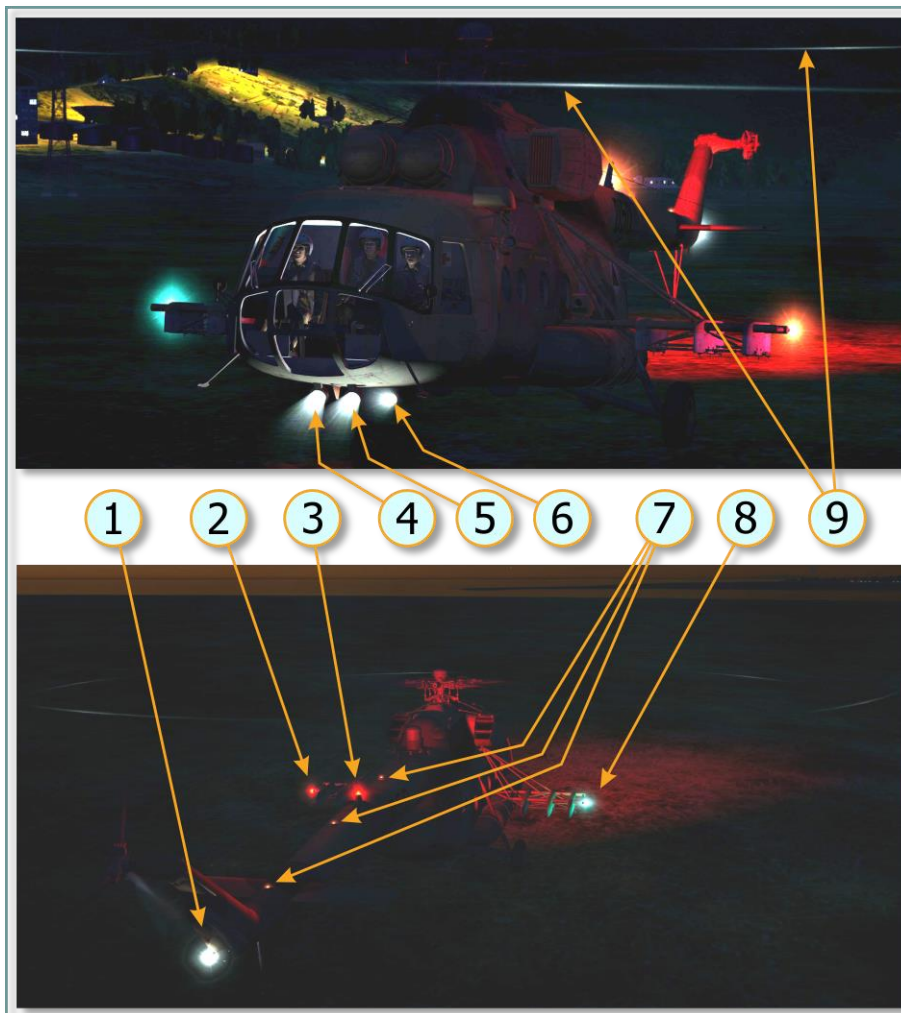

**Fig. 7.33. Exterior lighting equipment**

- |  |   |
|--|---|
| 1. KhS-39 tail light                   | 6. FR-100 taxi light                      |
| 2. Left BANO-45 navigation light (red) | 7. OPS-57 formation lights                |
| 3. MSL-3 anti-collision light          | 8. Right BANO-45 navigation light (green) |
| 4. Right pilot's FPP-7M light          | 9. Blade tip lights                       |



## 5. Left pilot's FPP-7M light

Electrical circuits of the exterior lighting system are connected via ACBs, located on the right over head circuit breaker panel, [Fig. 7.34](#):

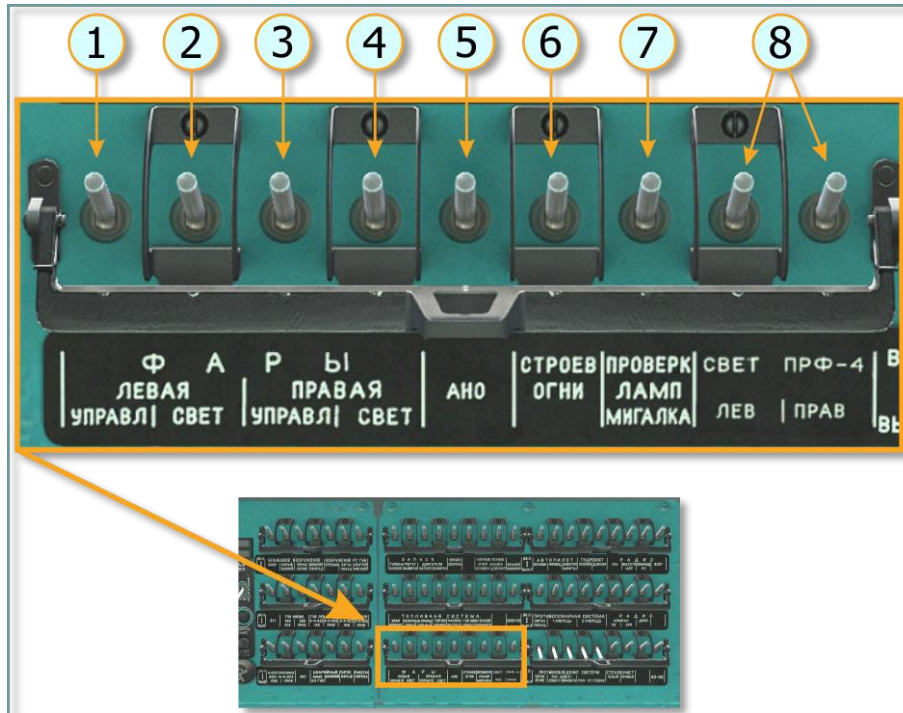

**Fig. 7.34. The ACBs of the exterior lighting system**

- |  |  |
|--|--|
| 1. Left search/landing light, light control circuit  | 4. Right search/landing light, incandescent light bulb circuit     |
| 2. Left search/landing light, incandescent light bulb circuit  | 5. Navigation lights' supply circuit                               |
| 3. Right search/landing light, light control circuit and incandescent light bulb circuit of taxi light | 6. Formation lights' supply circuit                                |
|  | 7. МИГАЛКА (FLASH) circuit   |
|  | 8. PRF-4 lights (on the main landing gear struts, not implemented) |

The ACB of the anti-collision light is located on the right side console (see below).

***FPP-7M search/landing light***

There are two FPP-7 search/ landing lights, mounted under the helicopter nose section to the right and left of the longitudinal centerline ([Fig. 7.33](#) , 4, 5)



. The lights are designed for search operations during low visibility conditions, searching and illuminating landing sites and taxi areas at night.

The lights can be elevated at angle from 0 (down) to up to 120° and turned at any angle in azimuthal direction or can be retracted.

The right FPP-7M lights is connected to the battery circuit, and the left one to the rectifier bus. In the light control and incandescent light bulb circuits are automatic circuit breakers, located on the right over head circuit breaker panel



Turning on the lights and supplying electrical power to the extension/retraction and rotation switches is done with help of two ФАРЫ СВЕТ – ВЫК – УБРАНА (LIGHT ON – OFF - RETRACTED) switches, when they are set to the СВЕТ (LIGHT) position



[LShift + L]

[RShift + L]

These switches are located on separated panels, attached to the left of the pilot's instrument panel and to the right of the co-pilot's one (Fig. 7.35, 2 ,3):



Fig. 7.35. Lights controls

1. Left pilot's FR-100 taxi light switch
2. Left pilot's FPP-7M search/landing light control switch
3. Right pilot's FPP-7M search/landing light control switch

Extension, retraction (beam elevation control), rotation to the left and to the right (azimuth control) is performed with help of two five-position hats, located on the collectives, [Fig. 7.36](#):



**Fig. 7.36. Search/taxi light beam controls**

1. Light (beam) forward (up) **[LShift + 8]** (left light) / **[RShift + 8]** (right light)
2. Light (beam) rotation to the right **[LShift + 0]** / **[RShift + 0]**
3. Light (beam) backward (down) **[LShift + 7]** / **[RShift + 7]**
4. Light (beam) rotation to the left **[LShift + 9]** / **[RShift + 9]**

When the ФАРЫ СВЕТ – УБРАНА (LIGHT ON –OFF - RETRACTED) switches are set

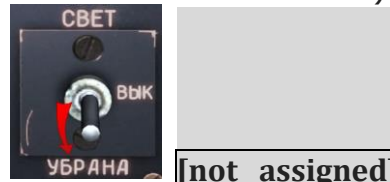

to the УБРАНА (RETRACTION) position **[not assigned]**, lights turn off and retract automatically. During retraction, the lights are automatically returning to their initial position in relation to the helicopter centerline. Fully extended and retracted positions are locked with help of limit switches.



The ВЫК (OFF) position **[LShift + ;]** (neutral) **[LShift + ;]** (first press) is used for preserving position of the light, when light is OFF. In game, this is a default position.

*FPP-7M FEATURES* are shown in Table 7.2

**Table 7.2**

Nominal supply voltage, V	27
Current, consumed by the each electrical motor, A, not more	0,7

Consumed power, Watt, not more	480
Nominal luminous intensity, cd	300000
Extension elevation angle, degrees	from 0 to 120
Rotation angle (azimuth)	not limited
Weight, kg, not more	3

### ***FR-100 taxi light***

The light is used for illuminating surface while taxiing. The taxi light is located on the



lower part of the fuselage (in real life, used for saving service life of the landing lights).

It is supplied by the battery bus via the ФАРЫ ПРАВАЯ УПРАВЛЕНИЕ (LIGHTS



RIGHT CONTROL) ACB , and turns on by the ФАРЫ – РУЛЁЖНАЯ (LIGHTS -TAXI) switch, located near the left FPP-7 switch, ([Fig. 7.35](#), 1) **[RCtrl + L]**.

### ***MSL-3 anti-collision light***

The MSL-3 anti-collision light is designed to indicate the direction of travel and the position of the helicopter at night, during inclement weather, and in poor visibility. It is used to indicate the place of helicopter in case of emergency landing. The MSL-3

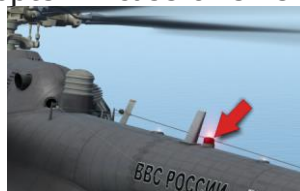

light is located on the top of the tail,

. This light is turned on by

the ПРОБЛЕСК МАЯК (ANTI-COLLISION LIGHT) ACB, located on the right electrical

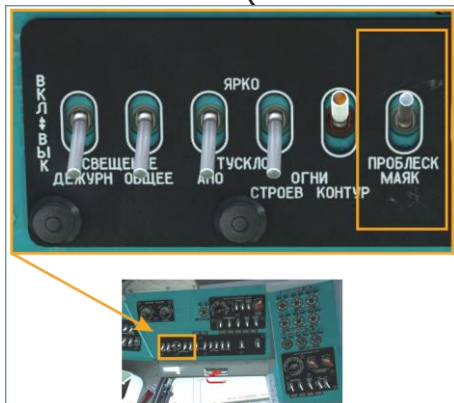

panel

[RCtrl + 6].

This light is connected to the battery bus (on some models, for example Mi-8MTVx – to the rectifier bus).

To avoid overheating, do not operate the anti-collision light for more than 10 minutes on the ground if the main rotor is not turning (not implemented).

### Navigation lights

Navigation lights are used for indication of helicopter position.

On the helicopter the BANO-45 type navigation lights and the KhS-39 tail light are installed.



The red and green navigation lights are installed on the weapon rack tips



or on the starboard and port sides of the nose part of the fuselage



(if weapon racks and armor are not mounted), KhS-39 is



installed on top of the tail

Navigation lights are supplied via the "АНО" (NAVIGATION LIGHTS) ACB, located on



the right over head circuit breaker panel

Navigation



lights are controlled (enabling and selection of the illumination intensity) by the АНО ТУСКЛО –(neutral)– ЯРКО (NAVIGATION LIGHT DIMINISHED- neutral - BRIGHT) switch, located on the electrical panel of the right side console.

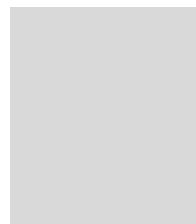
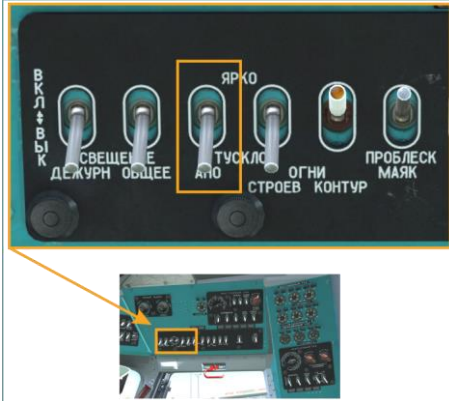

ТУСКЛО (DIMINISHED) – [RCtrl + 1] (down), ЯРКО (BRIGHT) –

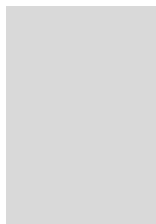
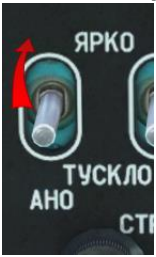

[RCtrl + 2] (up). Neutral position turns of all navigation lights.

The arbitrary light signal codes can be given with help of the "КОД-АНО" (NAVIGATIONAL LIGHT CODE) button, located on the left side console



### OPS-57 Formation lights

The OPS-57 formation lights are designed to assist pilots in maintaining formation while flying at night and in poor visibility conditions. There are three formation lights

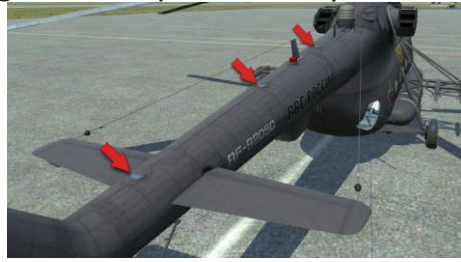

on the helicopter

The formation lights are supplied by the rectifier bus via the СТРОЕВ ОГНИ (FORMATION LIGHTS) ACB, which is installed on the right over head circuit breaker

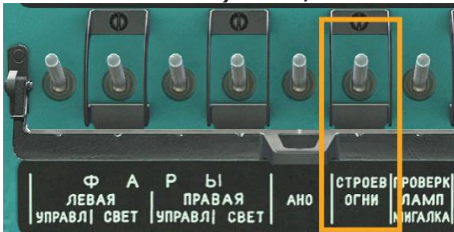

panel

. These lights are controlled (enabling and selection of illumination intensity) with help of the ОГНИ СТРОЕВ ТУСКЛО – (нейтраль)– ЯРКО (NAVIGATION LIGHTS DIMINISHED –(neutral) -BRIGHT), installed on the electrical panel of the right side console

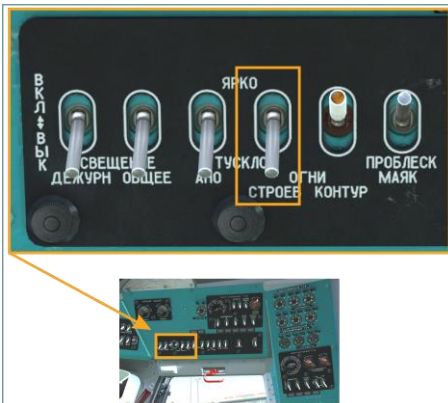

ТУСКЛО (DIMINISHED) –

[RCtrl + 3]

(down), ЯРКО (BRIGHT) –



[RCtrl + 4]

(up) . Neutral position turns of all formation lights.

### ***Blade tip lights***

The blade tip lights are used to indicate the position of the main rotor blades for movement of the helicopter at night or in poor visibility. A blade tip light is installed inside a removable fairing on each



main rotor blade tip cap. This lights are enabled by the ОГНИ КОНТУР (BLADE TIP) switch, which is installed on the electrical panel of the right

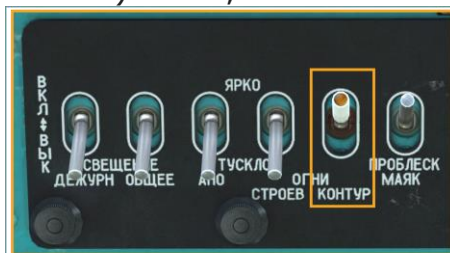

side console



[RCtrl + 5].

Blade tip lights are powered by the 115 VAC bus through the TR 115/7.5V transformer.

### **7.8.2. Interior lighting equipment**

The interior lighting system includes interior illumination of the cockpit, cargo cabin and various compartments, and in-helicopter light signalization system.

#### ***Cockpit illumination***

Cockpit illumination consists of:

- player flashlight;
- illumination of pilots' working space;
- red backlight system.

#### ***PLAYER'S FLASHLIGHT***

Player's flashlight is used to ease navigation in the cockpit during night missions with



cold start . It can be turned on/off by pressing the **[LAlt + L]** keys and controlled by the mouse.

#### *ILLUMINATION OF PILOTS' WORKING SPACE*

Cockpit is illuminated by the white (main) and red (backup) light with help of two



dome lights , installed on the cockpit ceiling on both sides of the helicopter. Each dome light contains two bulbs – one is white and the other is red. These lights turn on by the ПЛАФОН КРАСНЫЙ (DOME LIGHT RED) (up) – (neutral)–БЕЛЫЙ (WHITE) (down) switch. Neutral position turns off corresponding dome light. This switches are located on the triangular panels, [Fig. 7.37](#).



**Fig. 7.37. Backup dome lights**

#### *RED LIGHT BACKLIGHTING SYSTEM*

Red light backlighting system is used for backlighting various instruments and gauges on the instrument panels, central panel and electrical panel (right rear console).

Red light backlighting system of the central panel and electrical panel is divided on two groups. Group I is connected to the rectifier bus and group II to the battery bus. Red light backlighting system has no ACBs. Turning on of both groups and backlight intensity adjustment is performed with help of rheostats. To limit maximum voltage applied to red backlight system, rheostats have limiters.

Red light backlighting for the left overhead circuit breaker panel, left-side console, left triangular panel, left overhead console, pilot's instrument panel, KI-13 compass, left pilot's and cargo cabin's intercoms and left FPP-7M control panel is controlled by the **КРАСНЫЙ ПОДСВЕТ – ГРУППА 1 (RED BACKLIGHT –GROUP1)** and **КРАСНЫЙ**



ПОДСВЕТ – ГРУППА 2 (RED BACKLIGHT - GROUP2) rheostats, installed on the left



side console

Red light backlighting for the weapon console, R-863 radio control panels, right over head circuit breaker panel, right side console, right triangular panel, copilot's instrument panel and right FPP-7 control panel is controlled by the КРАСНЫЙ ПОДСВЕТ – ГРУППА 1 (RED BACKLIGHT –GROUP1) and КРАСНЫЙ ПОДСВЕТ – ГРУППА 2 (RED BACKLIGHT - GROUP2) rheostats, installed on the right side console



Red light backlighting of the central autopilot console, center overhead console, AC power control console, R-828, UV-27, Yadro-1M control panels, and panels installed in the doorway, is controlled by the КРАСНЫЙ ПОДСВЕТ – ГРУППА 1 (RED BACKLIGHT –GROUP1) and КРАСНЫЙ ПОДСВЕТ – ГРУППА 2 (RED BACKLIGHT -

GROUP2) rheostats, located on the right side of the cockpit doorway

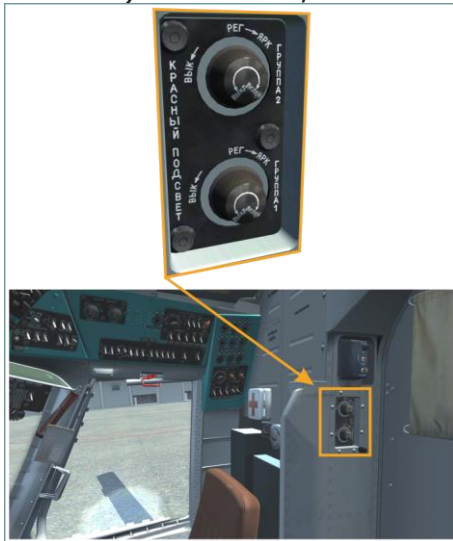

The 5.5V red backlighting (the "Подсвет 5,5V" (Backlight 5.5V)) system was designed to backlight gauges and instruments, installed on the Mi-8MT as part of modernization of the Mi-8T). It can be enabled by the ПОДСВЕТ 5,5В (BACKLIGHT



5.5V) switch, installed on the right triangular panel

Backlight intensity is regulated by the TR-100 transformer, mounted on the right



stand (behind the copilot's back) . Gauges, backlitged by the 5.5V backlighting system, are shown on [Fig. 7.38](#):



**Fig. 7.38. Instruments backlit by the "Подсвет 5,5V" (Backlight 5.5V) system**

Supply circuits of the red 5.5V backlight are connected to the 115 VAC generator bus.

#### ***Illumination of cargo cabin and technical compartments***

This function is not implemented.

#### ***In-helicopter light signalization system***

Monitoring of the helicopter's systems and units, besides dedicated instruments, is performed with help of in-helicopter light signalization system.

Signalization is done with help of light panels with light filters of red, yellow and green color, located on the instrument panels, central panel and electrical panel. For some light panel groups, some special operating modes are intended (FLASHING, DAY-NIGHT) and lamps checking.

The "MIGALKA" (FLASH) system is developed for attracting pilot's attention to the light panel, indicating malfunction or failure of some system, unit and informing him about emergency situations (fire, icing, excessive engine vibration, operation of backup systems, 270 liters of fuel remains in fuel tank). The operating principle of the "MIGALKA" (FLASH) is based on lamps, operating in impulse mode. Flashing

mode is enabled with help of a switch, located on the right side console



THE "ДЕНЬ-НОЧЬ" (DAY-NIGHT) system is intended to reduce illumination intensity for some instruments and light panels. This is done by setting the "ТАБЛО ДЕНЬ-НОЧЬ" (PANEL DAY-NIGHT) switch, located on the right side console

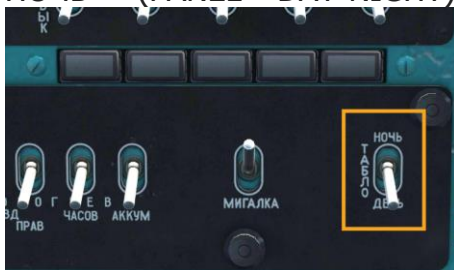

, to the "НОЧЬ" (NIGHT) (up) position. As a result, light panels, connected to the ДЕНЬ-НОЧЬ" (DAY-NIGHT) system will illuminate with half-intensity.

#### WARNING LAMPS CHECKING SYSTEM

To enable warning lamps checking system pilot must enable:

- АСВ "ПРОВЕРКА ЛАМП МИГАЛКА"(LAMP TEST FLASH)



- set the "ПРОВЕРКА СИГНАЛ ЛАМП – МИГАЛКИ" (WARN LTS - TEST-FLASH) switch, located on central panel, into "СИГНАЛ ЛАМП" (WARN



LTS)

**[LAlt + LCtrl + B]**.

(up)

position

As a result all signal panels will be on, except those, which are connected to the "МИГАЛКА" (FLASH) system, and those, which are on, when corresponding equipment is connected (for example, АЭРОДРОМНОЕ ПИТАНИЕ (GROUND POWER)).

When the switch "ПРОВЕРКА СИГНАЛ ЛАМП – (neutral) – МИГАЛКИ" (WARN LTS -

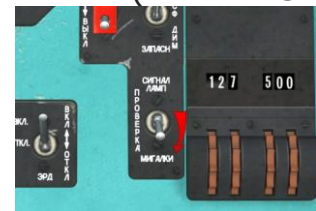

TEST- FLASH) is set to "ПРОВЕРКА МИГАЛКИ" (FLASH)  
(down)

**[LAlt + LCtrl + V]**, all light panels, connected to the "МИГАЛКА" (FLASH) system will be operating in impulse mode (flashing).

**Light panels, connected to the MIGALKA (FLASHING) system** are shown on [Fig. 7.39](#):



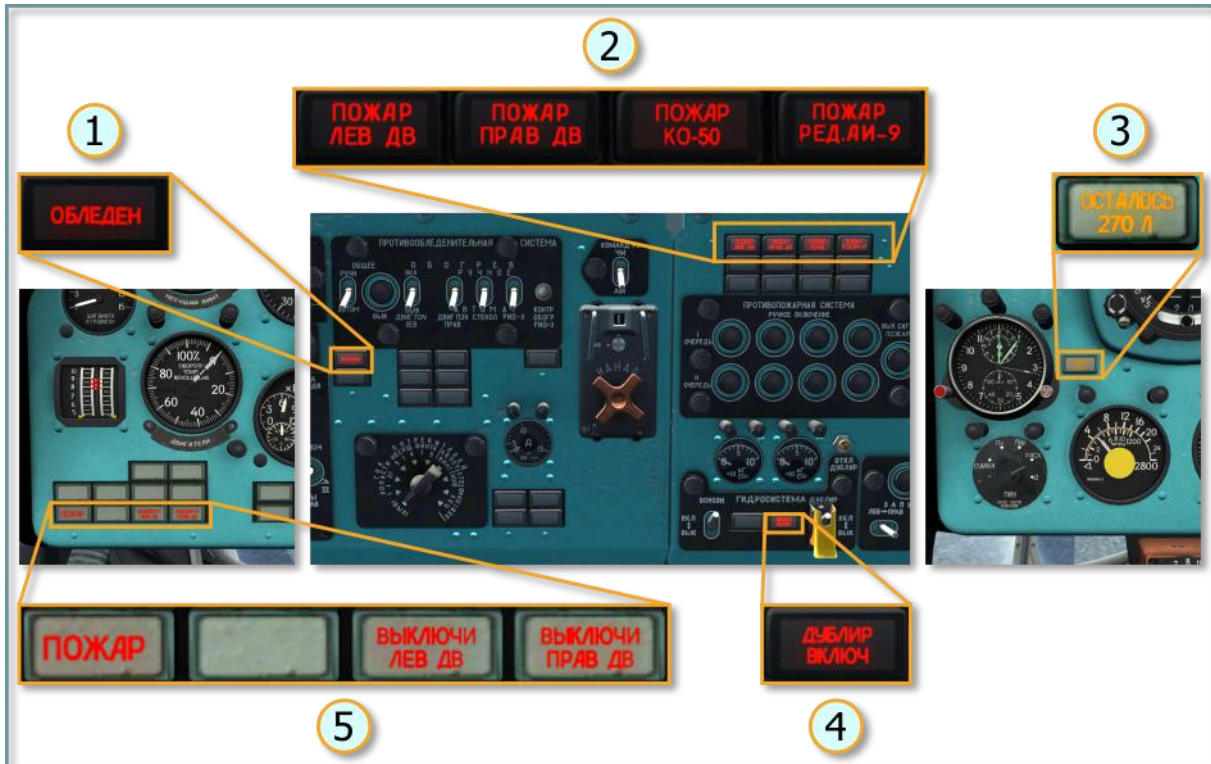

**Fig. 7.39. Light panels, connected to the MIGALKA (FLASH) system**

- |   |   |
|---|---|
| <p>1. ОБЛЕДЕНЕНИЕ (ICING)<br/>(started/continuing)</p> <p>2. Fire in compartments (from left to right):</p> <ul style="list-style-type: none"> <li>▪ ПОЖАР ЛЕВ ДВ (FIRE LEFT ENGINE)<br/>(in left engine's compartment)</li> <li>▪ ПОЖАР ПРАВ ДВ (FIRE RIGHT ENGINE)<br/>(in the right engine's compartment)</li> <li>▪ ПОЖАР КО-50 (FIRE КО-50) (fire in the heater)</li> <li>▪ ПОЖАР РЕД АИ-9 (FIRE TRANSMISSION АИ-9) (in the transmission compartment of the APU and in service fuel tank)</li> </ul> | <p>3. ОСТАЛОСЬ 270л (270 L REMAINS)(emergency fuel)</p> <p>4. ДУБЛИР ВКЛЮЧЕНА (BACKUP IS ON) (indicates that backup hydraulic system is operating, it automatically means failure in the utility hydraulic system)</p> <p>5. Fire annunciator ПОЖАР (FIRE), then – ВЫКЛЮЧИ ЛЕВ ДВ (STOP LEFT ENGINE), ВЫКЛЮЧИ ПРАВ ДВ (STOP RIGHT ENGINE) (signalization of excessive engine vibration, that can damage corresponding engine)</p> |
|---|---|

Circuits for checking warning lamps functionality, "МИГАЛКА" (FLASH) and "ДЕНЬ-НОЧЬ" (DAY-NIGHT) systems are connected to battery bus via the ПРОВЕРКА ЛАМП МИГАЛКА (LAMP TEST FLASH) ACB on the right over head circuit breaker panel.

## ***7.9. Registration of the flight parameters and voice recording***

### **7.9.1. SARPP-12DM flight data recorder**

This system is not implemented, but corresponding light panel and switch are animated.

The SARPP-12DM flight data recorder is designed to record the flight parameters of the helicopter under normal and emergency conditions.

The system continuously records the helicopter's barometric altitude, indicated airspeed, the position (tilt and height) of the main rotor swashplate, the main rotor RPM, and the helicopter pitch and roll angles. The system also records nine event-driven parameters. The trigger events include low fuel emergency, failure of any fuel boost pump, engine emergency power engagement, detection of a fire in any deck compartment, main hydraulic system failure, backup hydraulic system failure, loss of oil pressure in the main transmission, engagement of engine and particle separator anti-ice system (right engine only), and engagement of rotor deice system. All data is provided to the recorder via sensors, pressure switches, and/or transducers installed in the monitored systems.



**Fig. 7.40. SARPP-12D1M FDR power switch and indicator light, left side panel**

The recorder may be turned on manually or set for automatic operation using the "САРПП-12Д1М "РУЧН – АВТОМ"" (FLIGHT RECORDER) switch on the pilot's left side panel. When the switch is placed in the AUTO (down) position, the system is turned on automatically just after takeoff, when the AM-800K microswitch in the left main landing gear strut is activated. The microswitch activates when the weight is removed from the main landing gear. If the film transport and light-beam in the K12-51DM data storage unit are operational, the "САРПП РАБОТАЕТ" (SARPP WORKING) indicator light, located near the switch, will blink. In AUTO mode, the system activates only if there is sufficient pressure in the main or reserve hydraulic system

The flight recorder system consists of:

- K12-51DM data storage unit;
- УсС-4-1М UsS-4-1М matching device;
- sensors.

The SARPP-12 system is enabled by the "САРПП-12Д РУЧН-АВТОМ" (SARPP-12D



MANUAL-AUTO) switch on the left side console

To enable the system before engine start, set the corresponding switch to the "АВТОМ." (AUTO) or РУЧН (MANUAL) position **[LAlt + LCtrl + LShift + 6]** .

When this switch is set to the АВТОМ. (AUTO) position, the flight recorder begins operating only if there is enough pressure in the utility or backup hydraulic system, or if limit switches in the main landing gear struts trigger when helicopter is airborne. If set to the РУЧН. (MANUAL), recorder engages immediately, indendently on pressure in the hydraulic systems.

Data storage unit in armored container and matching device are installed in the tail boom.

The SARPP-12DM system is supplied by the 27-29V onboard DC bus, and in emergency mode by the battery bus, through PM-10 SARPP ACB, located on the ACB panel.

Continuous operating time of the SARPP-12 system is not less than 5.5 hours.

### 7.9.2. P-503B voice recorder

Not implemented, but corresponding switch is animated.

Voice recorder is designed for recording voice information of the helicopter's pilot, transmitted over radios and intercoms, as well as information given to the pilot.

The voice recorder is controlled by the pilot, using the control panel located on the



left side panel

The voice recorder is supplied by the 27 V DC bus under normal circumstances and by the battery bus in emergency cases.

## 7.10. Sling load equipment

### 7.10.1. General description

Sling load equipment is used for transporting large-sized cargo under the helicopter's fuselage, for releasing cargo at required point, and for performing construction and installation works, [Fig. 7.41](#).



**Fig. 7.41. Helicopter with a sling-load**

The helicopter has cargo cable set with maximum load of 4000 kg with length of cargo cables of 4 meters. Cargo is released by opening electrical cargo hook remotely.

Sling load equipment set consists of:

- 4 cables;
- DG-64M cargo hook;

- fuselage attach points;
- release barrier;
- pulley block and cable (not modelled);
- extension cables for 5, 10, 15, 20, 30, 40, 50 и 65 m (up to 30m in game);
- cargo cable set (4x4m), also known as "spider" (any length is possible in the game);
- various additional details (swivel hook, master link of cargo cable set), are not modelled.

The main load-bearing elements of the outer sling cable are four 16-mm cables. On top of each cable there is a hinge by which this cable is attached to a special fuselage attach point, located under helicopter's ceiling (directly under the main rotor transmission) on frames № 7 and 10. In the lower part all four cables are connected with the scale of the DG-64M and then cable goes through the access hole. Sling load equipment is shown on [Fig. 7.42](#).

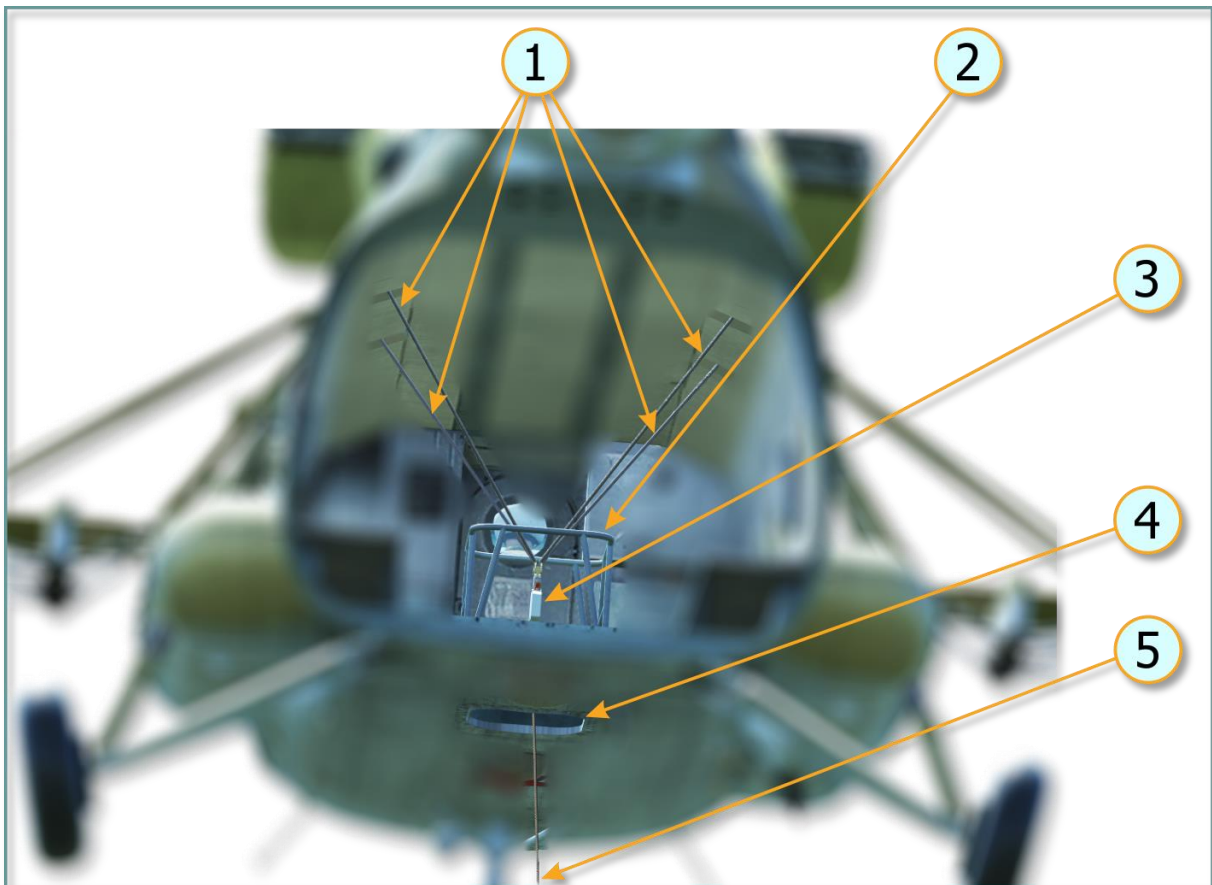

**Fig. 7.42. Sling load equipment diagram**

- |                             |                     |
|-----------------------------|---------------------|
| 1. Four load-bearing cables | 4. Access hole      |
| 2. Release barrier          | 5. Extension cables |
| 3. DG-64M cargo hook        |                     |

### 7.10.2. Cargo hook controls

The DG-64M cargo hook lock is controlled electrically:



- supply voltage is 27-29V;
- minimum voltage required for hook opening is 20V.

Controlling cargo hook lock means choosing the unhook method: either automatic opening (or unhook) when cargo touches the ground or manually opening the lock in flight (and cargo release).

To power up electrical circuits, controlling hook lock, pilot must enable the "УПРАВЛЕНИЕ ОТКРЫТИЕМ ЗАМКА" "ОСНОВНОЕ", "ДУБЛИР" (CARGO HOOK MAIN AUX) on the right overhead circuit breaker panel:

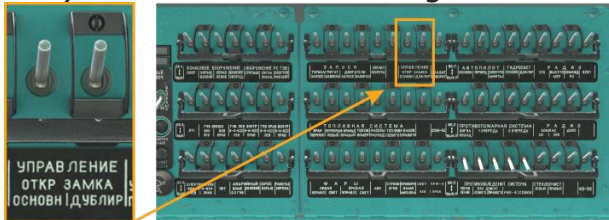

### ***Automatic opening***

Automatic cargo unhook is activated before landing when cargo is already hooked. To do that, one must enable the ВНЕШНЯЯ ПОДВЕСКА АВТОМ СБРОС (EXTERNAL LOAD AUTO RELEASE) switch (UP), located on the left side panel:



When cargo touches ground and load on lock lever reduces to less than 25 kg, hook opens and cargo remains on the ground. When lock is opened, the ЗАМОК ОТКРЫТ

(HOOK OPEN) light panel is on .

### ***Manual cargo release***

Cargo hook can be opened during flight (cargo release). Two procedures are used for that: normal (tactical) release and emergency cargo release, if emergency situation occurs during the flight.

To open hook lock with help of electromagnetic trigger, pilot has to press tactical cargo release button or emergency cargo release button. Both buttons are located on collective, Fig. 7.43.



**Fig. 7.43. Cargo release buttons on the collective**

- |   |   |
|---|---|
| <p>1. Safety cover of the ABAP CBPOC (EMERGENCY RELEASE) button <b>[RCtrl + Rshift + Ralt + R]</b></p> <p>2. Emergency release button <b>[RCtrl + Rshift + Ralt + P]</b> or <b>[RCtrl + Rshift + Ralt + A]</b> (only if safety cover is opened)</p> | <p>3. Tactical release button <b>[RCtrl + Rshift + Ralt + L]</b> or <b>[RCtrl + Rshift + Ralt + Q]</b> (only if safety cover is opened)</p> <p>4. Safety cover of the TAKT CBPOC GPY3A (TACTICAL CARGO RELEASE) button <b>[RCtrl + Rshift + Ralt + T]</b></p> |
|---|---|

There is no any difference for player in tactical or emergency cargo release during flight, result is completely the same. The only difference between tactical and emergency release is that release signal goes via different electrical circuits to open the DG-64 cargo hook. In both cases, when hook is opened, the ЗАМОК ОТКРЫТ

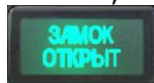

(HOOK OPEN) light panel is on

Cargo hook is closed manually (in this game it closes automatically, if cargo is selected with help of radio menu and player hovers over the cargo for some amount of time, see here).

Sling load operation (selection of the cargo, attachment and release) is described here.

## **7.11. АП-34Б (AP-34B) autopilot system**

### **7.11.1. General description**

The AP-34B four-channel electrical-hydraulic autopilot system is designed to stabilize the helicopter in roll, pitch, heading, altitude, and airspeed. The autopilot is

a system, receiving information about changes in angular positions of the helicopter, barometric altitude and instrumental airspeed. It has four independent autopilot channels, controlling corresponding helicopter's controls:

- yaw channel – tail rotor pitch;
- roll channel – swashplate in lateral direction;
- pitch channel- swashplate in longitudinal direction;
- altitude channel – main rotor pitch;

When the altitude channel is engaged, the pitch channel receives correction signals from the КЗСП (KZSP) airspeed correction unit to stabilize the airspeed.

The four autopilot channels (roll, pitch, yaw, altitude) provide:

- stabilization of helicopter's position in three axes (longitudinal, lateral, vertical);
- stabilization of altitude, during sustained level flight and hover;
- stabilization of indicated airspeed.

### ***AP-34B autopilot system specifications:***

Supply voltage, DC	+28.5 V
Supply voltage, AC	~36 V (3Ph), 400 Hz
Time to readiness	under 2 min
Controls travel range in percents of full travel range, given to the autopilot:	20%
Autopilot stability in calm atmosphere conditions:	
yaw channel	$\pm 1^\circ$
roll channel	$\pm 0,5^\circ$
pitch channel	$\pm 0,5^\circ$
altitude	$\pm 10$ m
airspeed	$\pm 10$ km/h
Max altitude	10000 m
Weight	under 25 kg

### **7.11.2. Autopilot system's unit**

The AP-34B autopilot system includes the following units:



- control panel
- control unit, it is needed for transforming, accumulating and amplifying of the control signals (fully modeled);
- yaw, roll and pitch angular velocity sensors (fully modeled);
- amplifiers unit (fully modeled);



- ИИ-4 (IN-4) zero indicator
- three compensation sensor (in each channel, fully modeled);
- KB-11 (KV-11) altitude corrector (fully modeled).

The АП-34Б (AP-34B) autopilot and control system mechanisms are powered by 27V DC from the onboard battery and rectifier buses bus via the АВТОПИЛОТ-ОСНОВН. (AUTOPILOT-MAIN), АВТОПИЛОТ-ФРИКЦ. (AUTOPILOT-FRICT) and АВТОПИЛОТ-



ЭЛЕКТРОМУФТЫ (AUTOPILOT-SOLENOID CLUTCHES) circuit breakers. All circuit breakers are located on the right circuit breaker console. Additionally, system is powered by the 36 VAC 400 Hz from 36 V three-phase generator buses.

### 7.11.3. Autopilot controls and indicators

#### *Control panel*

The autopilot control panel is located on the center console and provide the following functions:

- zeroing of autopilot control input prior to engaging the autopilot;
- individual engagement/disengagement of autopilot channels;
- entering of small corrections ( $\pm 10\%$ ) using the centering knobs for pitch, roll, and yaw channels;
- testing of the altitude channel using the "КОНТРОЛЬ" (TEST) switch.

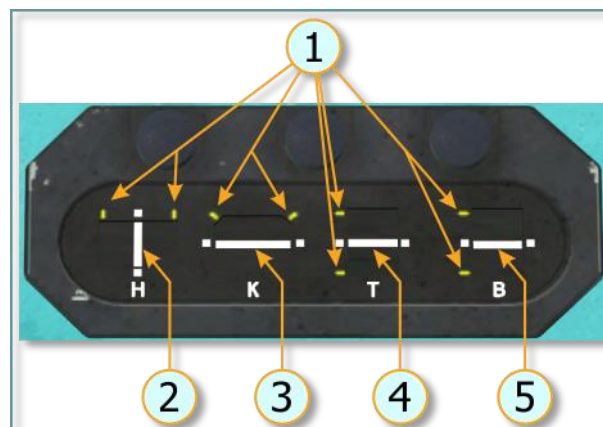

**Fig. 7.44. Autopilot control panel**

- |  |   |
|--|---|
| <ol style="list-style-type: none"> <li>1. Lamp-button, enabling yaw channel</li> <li>2. Lamp-button, disabling yaw channel</li> <li>3. Lamp-button, enabling pitch and roll channels</li> <li>4. Lamp-button, disabling altitude channel</li> <li>5. Lamp-button, enabling altitude channel</li> </ol> | <ol style="list-style-type: none"> <li>6. Rotating scales, indicating mismatch between signals from yaw, roll and pitch sensors and actual controls position (1 mark corresponds to 1°)</li> <li>7. КОНТРОЛЬ (CONTROL) button for checking the altitude channel</li> <li>8. Pitch channel centering knob</li> <li>9. Roll channel centering knob</li> <li>10. Yaw channel centering knob</li> </ol> |
|--|---|

#### ***ИИ-4 (IN-4) zero indicator***

The ИИ-4 (IN-4) zero indicator unit shows the relative displacement of the flight control servo spindle for each autopilot channel. It is located on the center console.



**Fig. 7.45. ИИ-4 (IN-4) zero indicator**

- |   |   |
|---|---|
| <ol style="list-style-type: none"> <li>1. Maximum deflection marks</li> <li>2. Yaw channel indicator</li> </ol> | <ol style="list-style-type: none"> <li>4. Pitch channel indicator</li> <li>5. Altitude channel indicator</li> </ol> |
|---|---|



### 3. Roll channel indicator

In other words, these indicators show center position of the control range, given to the autopilot, relative to the helicopter controls such as pedals, collective or cyclic. See below for explanations.

#### 7.11.4. Equipment interacting with the autopilot system

- The GMK-1A gyro compass system provides signals to the autopilot control panel to stabilize a given heading of the helicopter. Besides that, this system gives signal to the control panel to engage alignment/matching mode for the yaw channel, when course set mode and course system check are enabled. This functionality is enabled, when the НАПРАВЛЕНИЕ (YAW) channel is engaged.
- AGB-3K ADI of the co-pilot is a roll and pitch sensor for the autopilot system. It is used when the ROLL-PITCH channel is engaged.
- The КЗСП (KZSP) airspeed correction unit is designed to provide an electrical signal, proportional to the deviation of the actual speed from the required one. The КЗСП (KZSP) affects pitch channel. It is used, when the altitude channel is engaged.
- The БСГ (BSG) ready signal unit operates together with the КЗСП (KZSP) and provides ready signal, when КЗСП (KZSP) correction calculation system is operational.
- Combined KAU-30B control units (control actuator) and RA-60B steering unit (control actuator) are executive units for both helicopter and autopilot. They affect helicopter's controls (swashplate of main rotor and pitch control of tail rotor). Four steering units are installed in lateral and longitudinal channels, collective channel and pedals channel. These steering units have built-in feedback sensors, with help of which autopilot receive feedback, see below.
- Electromagnetic valves (GA-192), using signals from the autopilot, engage steering units in autopilot mode (details described below).
- Two Выкл. АП (AUTOPILOT OFF) buttons are installed on cyclics **[LWin + LShift + A]**.
- Two buttons disengaging altitude channel, installed on the collectives (their press is emulated when position of collective has been changed or collective control buttons have been pressed - **[Num -]** or **[Num +]**).
- Four small-sized switches on the pedals. When pilot puts feet on the pedals, these switches trigger and alignment mode engages for the yaw channel.
- Small-sized switch, located on mechanical rocker of the SPUU-52 tail rotor pitch limit system, which is used to engage alignment mode for yaw channel, when mechanical rod in pedal channel is close to the mechanical stop, position of which is defined by the SPUU-52 system (i.e. yaw channel disengages when mechanical stop is reached).
- Time relay with 0.5s delay, included in yaw channel, to prevent oscillations, when autopilot switches to alignment mode.

- Autopilot's distribution box (not modelled).

Due to fact that the AP-34B autopilot operates together with the KAU-30B and RA-60A electro-hydraulic executive units (control actuators), controls of the helicopter can be controlled by the pilot, using normal helicopter controls (cyclic and collective) and by the autopilot simultaneously (so called combined mode, when pilot can overrule autopilot at any time while autopilot is engaged). In this mode, autopilot affect small cylinder of the steering unit, which is, in its way, an adjustable rod, included into the control system. Due to that, resulting movement of the controls is a sum of pilot's and autopilot's control inputs. Movements of the executive steering units, due to signals from the autopilot, are not transferred back to cyclic and collective.

Besides that, the autopilot can operate in the automatic helicopter stabilization mode (when all four channels are engaged). Peculiarities in operation of the hydraulic units in cases of autopilot and manual control are [described below](#).

When the altitude channel is engaged, the pitch channel receives correction signals from the КЗСП (KZSP) airspeed correction unit.

Autopilot roll, pitch, and altitude correction signals are limited to a maximum of 20% of control travel for flight safety in the event of false signals or system failure. In addition, the pilot may intervene at any time while the autopilot is engaged to make manual corrections by operating the flight controls.

#### 7.11.5. Use of autopilot in different flight phases

The autopilot system is engaged for all normal flight operations. The pitch and roll channel is normally engaged throughout the flight from takeoff to landing. Yaw and altitude channels are used rarely.

The autopilot is engaged before takeoff, by pressing lamp-buttons, corresponding to



the required channels. The altitude channel can not be engaged without engaging "ROLL-PITCH" channel.

**When performing vertical takeoff**, one must enable "ROLL-PITCH" channel (pilots, operating Mi-8 in Russian Federation, normally do not engage "YAW" channel before takeoff).

**When performing rolling takeoff**, engage only "ROLL-PITCH" channel. Engaging must be monitored with help of lamp-buttons, which should be green for engaged channels.

**When in hover**, the autopilot stabilizes the helicopter in pitch and roll, as well as heading when the pedals are released (feet off the pedals). Autopilot functionality in hover mode can be verified by checking the zero indicator unit for fluctuations in the "K" (roll channel) "T" (pitch channel) "H" (yaw channel) servo displacement indicator needles around neutral positions.

**In sustained flight conditions such as level flight**, climb or descent with flight controls released by the pilots, the autopilot will stabilize the helicopter attitude while slowly decreasing airspeed, because the system is maintaining a pitch angle and not airspeed (up to 150 km/h).

### **Piloting the helicopter with help of autopilot without moving controls**

To adjust a helicopter heading, within  $\pm 5^\circ$  range during sustained level flight, while autopilot is engaged, one must rotate the centering knob on the autopilot control

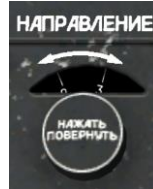

panel clockwise or counterclockwise . Complete rotation of this knob results in heading change of  $10^\circ$ . There are ten ticks on the scale, each tick corresponds to  $1^\circ$  . In a similar way, the roll and pitch can be adjusted.

The altitude channel can be engaged after establishing level flight at an altitude of not less than 50 m. Altitude channel operation can be verified by fluctuations of the "B" (altitude channel) servo displacement indicator needle on the zero indicator unit, changing of the main rotor collective pitch angle on the UP-21-15 gauge, and vertical displacement of the helicopter as the autopilot system maintains altitude in turbulent air.

**Landing approach**, braking, and landing are normally performed with the autopilot channels "ROLL" and "PITCH" engaged. After landing, the autopilot system is disengaged with the "ВЫКЛ. АП" (Autopilot OFF) button, located on both cyclics



### **7.11.6. Explanations of the AP-34B peculiarities and key commands**

#### ***Combined operation of hydraulic boosters and the AP-34B autopilot in case of manual control***

In case of automatic helicopter stabilization, the actuating rods of the KAU-30B combined hydraulic boosters can move themselves within 20% of their full travel range, wherein control sticks (cyclics) do not move and are hold in the same fixed positions by the spring load mechanism. Collectives are hold by the friction mechanism.

Limitation of 20% (by design of steering units/ control actuators) of full travel range of is needed to provide flight safety in case of autopilot failure, because the most of the failures are accompanied with appearance of an one-way signal on the autopilot output and, as a result, fast reaction of the actuator units.

At the same time, this limited operating range of actuator units using autopilot signals is sufficient for compensation of real-life disturbances, affecting helicopter and for stabilization of angular positions of the helicopter.

The pilot may intervene at any time while the autopilot is engaged. For this purpose are centering knobs for pitch, roll and yaw channels, full rotation of which corresponds to 10° change. There are ten ticks on the scale, each tick corresponds to 1°.

By rotating corresponding centering knob clockwise or counterclockwise, pilot force the helicopter to turn. When pilot intervene roll or pitch, it is necessary to remove impact of signals from angular and angular velocity sensors on hydraulic boosters of roll and pitch channels. For this purpose the compensation sensors, kinematically connected with lateral and longitudinal controls, which provide signals, equal to ones received from attitude indicator, but with opposite sign, are installed. In other words, when pilot moves cyclic, the reference value of roll and pitch (which autopilot will maintain) is constantly being updated.

In this way pilot controls helicopter's roll and pitch, without disengaging autopilot, which is constantly trying to maintain helicopter's position, given by the pilot. For the pilot, to control yaw, on the pedals are triggers and microswitches, which, when pressed, enable alignment mode for yaw channel. When maneuver is finished and pedals are released, the autopilot for yaw channel engages automatically.

### ***Game peculiarities, when pedals are used and "НАПРАВЛЕНИЕ" (YAW) channel is engaged***

To control yaw in the Mi-8MTV2, the RA-60A steering unit is used. Unlike the KAU-30B, it has a special mechanism, allowing autopilot to move pedals, if limited travel range of 20% is not sufficient for maintaining given direction.

If, for example, yaw channel is engaged and player during vertical ascend is not compensating reactive moment of the main rotor with pedals, then after using 20% of limited travel range, the RA-60A will be moving the right pedal forward without any actions from player. Player pedals will remain in the same position. To align position of player pedals with position of virtual pedals in Mi-8 model, perform the following actions:

- return gaming pedals to a neutral position (if pedals have springs – simply remove feets from the pedals);
- reset trimmer **[LCtrl + T]**.

After this procedure the pedals in the model return to a neutral position and they will be aligned with gaming pedals.

NOTE. Take into account that this procedure returns cyclic into neutral position, as well.

### ***Trimmer features when autopilot is engaged***

As in real life, in our model interaction between trimmer and autopilot in the Mi-8 is different from the one, implemented in the Ka-50. In the Mi-8 depression and holding of the trimmer button do not engage alignment mode of the autopilot, as it is done in the Ka-50. I.e. trimmer as object is not interacting with autopilot at all.

Autopilot controls roll (pitch) within 20% of full cyclic travel range for this channel. The edge positions on the IN-4 zero indicator ([Fig. 7.45](#), 1) tell us that hydraulic boosters of roll or pitch (more precisely the small cylinders of the steering unit) reached 20% of travel range, given for automatic stabilization of roll and pitch angles. This appears as increased sensitivity in helicopter reaction on small cyclic movements to the side where limit was reached and creates certain discomfort for piloting.

The deviation of the center of the 20% zone, given to autopilot to stabilize helicopter, from current position of the cyclic, can be estimated with help of IN-4 ([Fig. 7.46](#), 2). If pilot, using trimmer, moved

cyclic outside this zone (according to indications on the IN-4), then autopilot is not able to “comfortably” stabilize roll (pitch) anymore, as before. Of course, pilot feels discomfort as well, even when applied forces were removed from cyclic by the trimmer. In practice, it requires increased amount of small cyclic corrections, needed for maintaining desired roll or pitch. To ease piloting, it is necessary align the center of autopilot’s 20% of range with the current position of the cyclic. In other words, “point” the autopilot to a new reference position. This can be done in the two following ways:

1. **By Centering knobs on the AP-34B control panel.** In real life, it is a crew chief, who normally, by rotating these knobs, removes misalignment, by setting roll and pitch according to horizontal marks. Pilot, during this process, must slowly move cyclic towards new position to maintain sustained flight, i.e. moving away from the position where autopilot was engaged and then trimming the cyclic once again.

2. **By disabling autopilot** and balance correction followed by the autopilot engagement.

The first approach is useful, because it gives an opportunity to smoothly remove misalignment, the second allows to do it fast without involving other crew members.

To better understand mentioned above features, see below.

### ***Positions of Cyclic and zero indicators on IN-4 during Hover and Level flight (Roll-Pitch channel)***

Below, the positions of cyclic, depending on moment when the “ROLL-PITCH” channel was enabled, are shown for hover and level flight.

#### *HOVER*

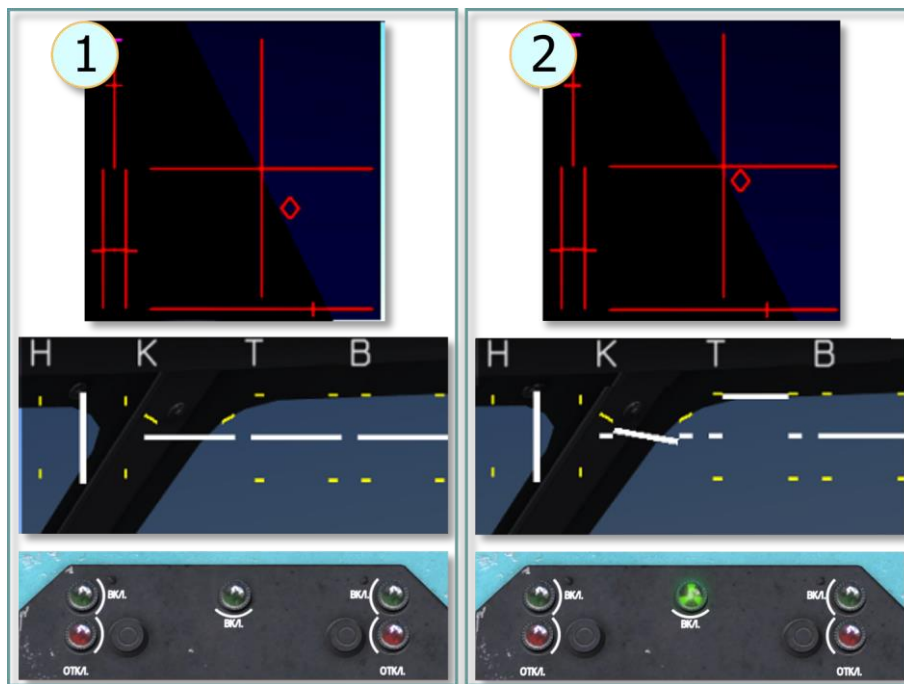

**Fig. 7.46. Hover**

1. Hover.  
AP-34B (Roll-Pitch channel) is OFF

2. Hover.  
AP-34B (Roll-Pitch channel) was turned ON while on the ground, when Cyclic is in neutral position



## LEVEL FLIGHT

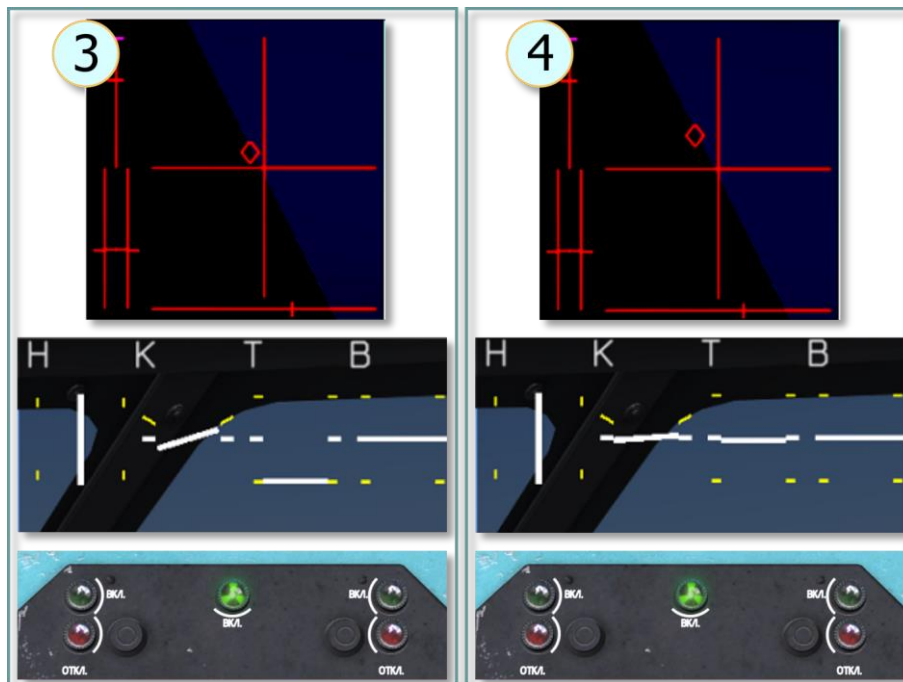

**Fig. 7.47. Level Flight at 240 km/h**

3. Speed 240 km/h.

The AP-34B has been turned ON during hover

4. Speed 240 km/h.

The AP-34B has been turned OFF during flight at 240 km/h and then ON again after helicopter was balanced.

In the game, there is an opportunity to adjust "ROLL-PITCH" with help of AI crew chief. Auto adjustment can be performed by a command from player (key combination) **[RAIt + A]** or automatically, if in the Mi-8MTV2 (see [14.8.1](#)) the "Autopilot Adjustment" checkbox is set, [Fig. 7.48](#).

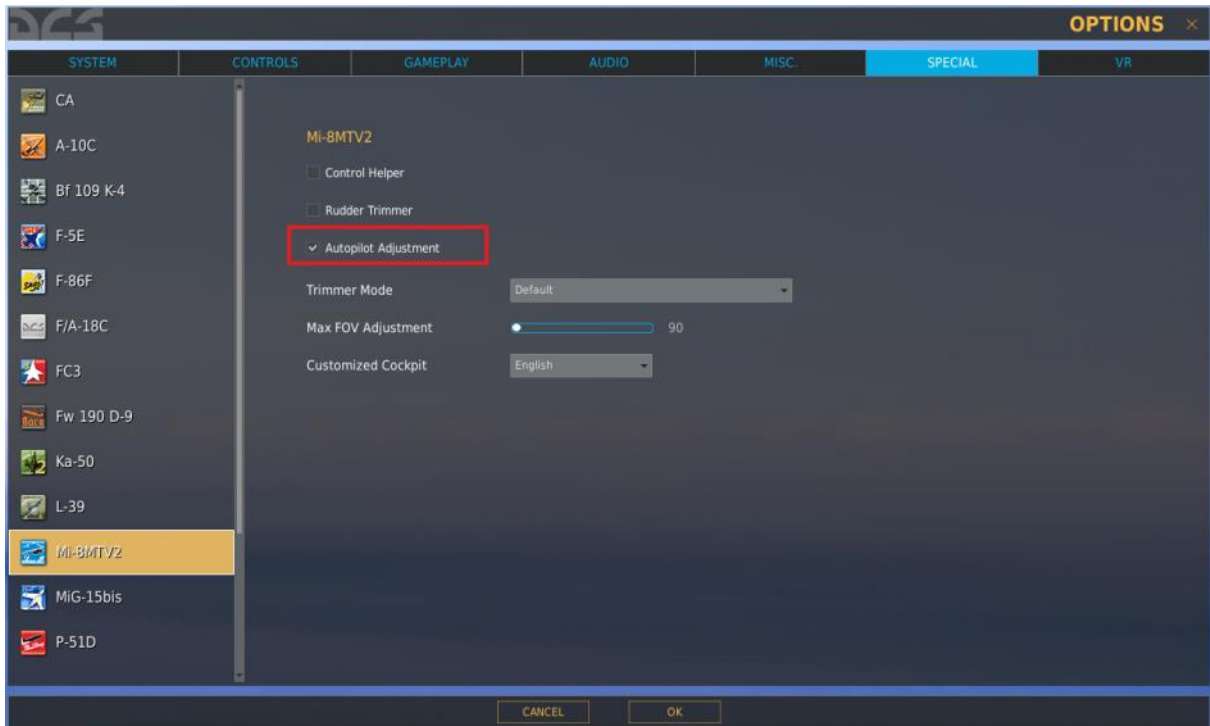

**Fig. 7.48. The "Autopilot Adjustment" checkbox in special settings**

When AI crew chief receives a command from the player to adjust the autopilot it will "report" about actions taken.

### ***AP-34B Key Commands***

<b>LAlt + LWin + A</b>	Autopilot Altitude Channel OFF Button
<b>LAlt + A</b>	Autopilot Altitude Channel ON Button
<b>LAlt + V</b>	Autopilot Altitude Control Switch - Down
<b>LAlt + F</b>	Autopilot Altitude Control Switch - Up
<b>LShift + LWin + S</b>	Autopilot Heading Adjustment Knob - CCW/Left
<b>LShift + LWin + D</b>	Autopilot Heading Adjustment Knob - CW/Right
<b>LCtrl + LWin + A</b>	Autopilot Heading Channel OFF Button
<b>LCtrl + A</b>	Autopilot Heading Channel ON Button
<b>LCtrl + LShift + S</b>	Autopilot Pitch Adjustment Knob - CCW/Left
<b>LCtrl + LShift + D</b>	Autopilot Pitch Adjustment Knob - CW/Right
<b>LWin + RCtrl + S</b>	Autopilot Roll Adjustment Knob - CCW/Left
<b>LWin + RCtrl + D</b>	Autopilot Roll Adjustment Knob - CW/Right
<b>LWin + A</b>	Autopilot Roll/Pitch Channel ON Button

## ***7.12. Exhaust IR suppression devices***

Installs exhaust IR suppression devices ([Fig. 7.49](#)). It decreases engines' IR signature by approximately two times. This reduces lock on range for IR SAMs and increases probability of successful flight through SAM protected areas.



**Fig. 7.49. Exhaust IR suppression devices**

**N O T E .** Installation of the IR suppression devices requires, according to flight manual, to reduce calculated takeoff weight by 300 kg. On the charts it is equal to increasing ambient temperature by +3°C. Besides that, empty helicopter weight is increased by 160 kg.



**8**

***OPERATING LIMITS  
AND RESTRICTIONS***



## 8. OPERATING LIMITS AND RESTRICTIONS

### 8.1. Calculating maximum takeoff weight

Maximum takeoff weight for out of ground effect vertical takeoff (landing) (OGE maximum hover weight) is displayed by [Fig. 8.1](#). Maximum takeoff weight for in ground effect vertical takeoff (landing) (IGE maximum hover weight) is displayed by [Fig. 8.2](#).

The maximum hover weight charts display maximum takeoff weight in relation to the pressure altitude of the landing field and free air temperature (FAT) assuming calm winds, 93% main rotor RPM, disengaged PZU Air Inlet Particle Separator System (PSS), disengaged anti-ice systems.

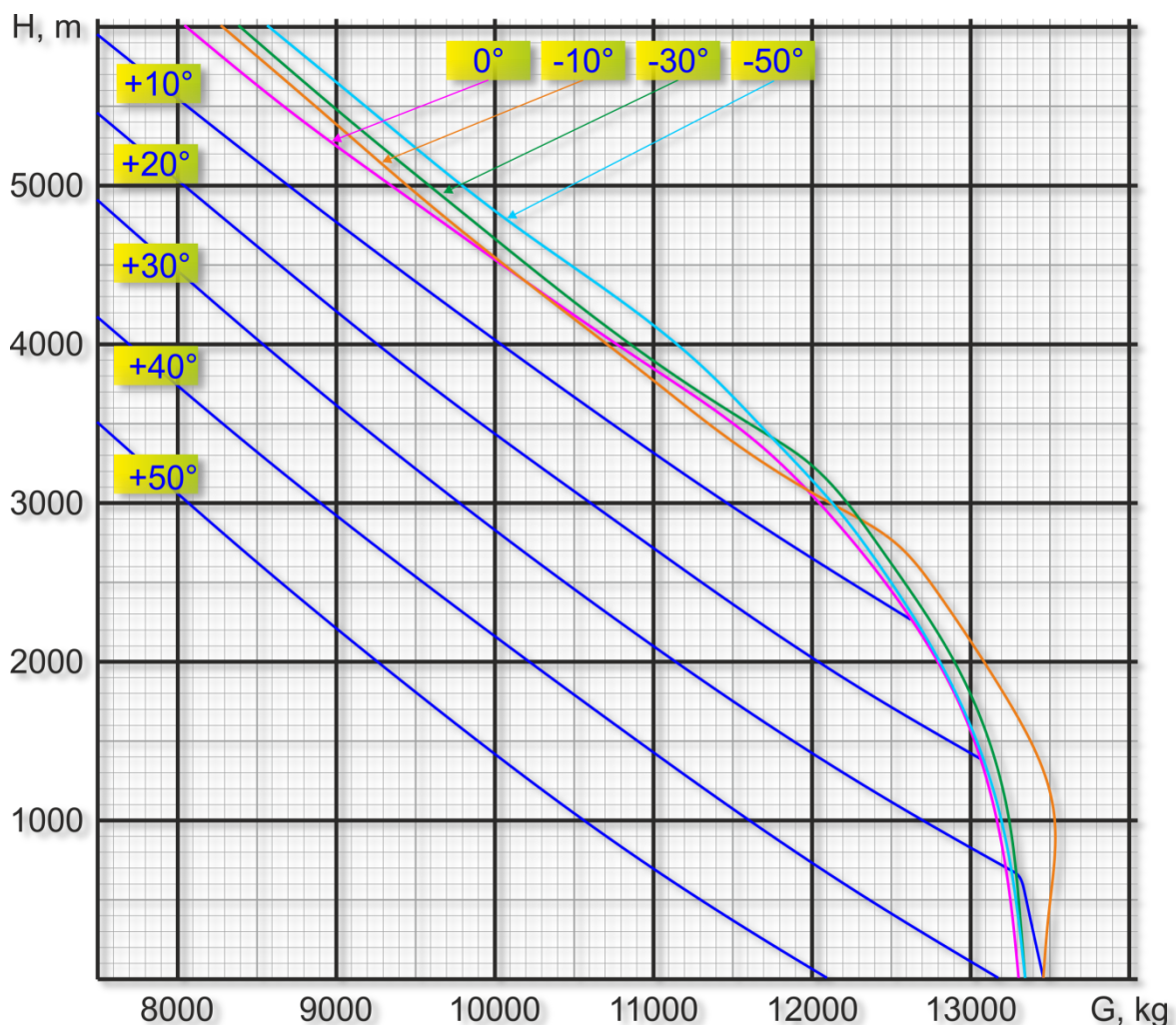

**Fig. 8.1. OGE maximum hover weight chart (hover altitude 20 m).  
PZU and anti-icing disabled**

**N O T E .** If EGS installed, reduce maximum weight indicated in chart by 300 kg.

With PZU (PSS) turned on, reduce maximum takeoff weight indicated in chart by 200 kg. With engine and rotor anti-ice systems turned on, reduce maximum takeoff weight indicated in chart by 1000 kg.



When Exhaust IR suppression devices (7.12) are fitted reduce maximum takeoff weight indicated in chart by 300 kg.

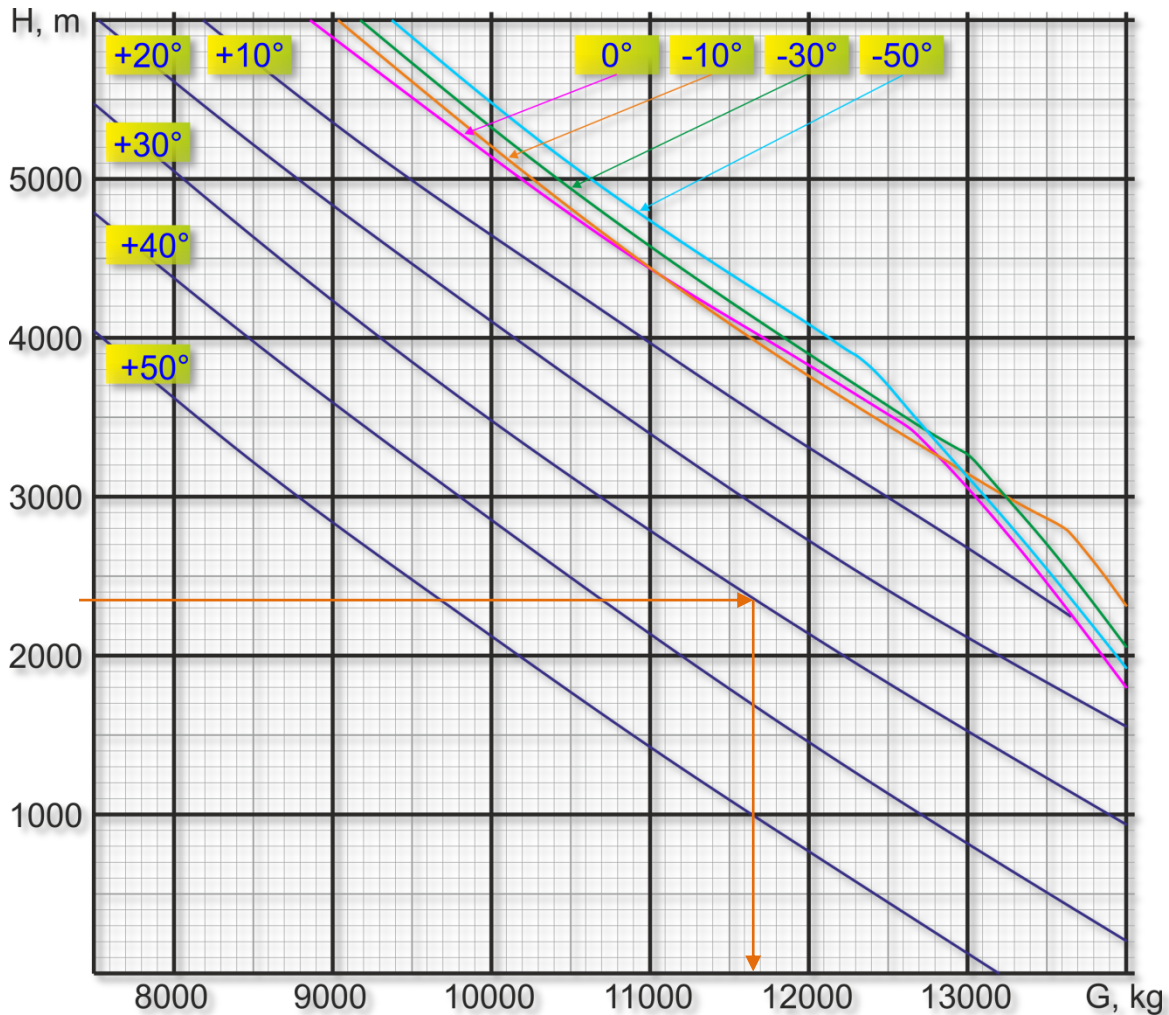

**Fig. 8.2. IGE maximum hover weight chart (hover altitude 3 m).  
PZU and anti-icing disabled.**

Any headwind increases maximum takeoff weight: +200 kg at 5 m/s; +1200 kg at 10 m/s.

Crosswind up to 5 m/s reduces performance by affecting the tail rotor and increasing engine power requirements. Reduce maximum takeoff weight by 200 kg in the presence of a crosswind of up to 5 m/s. At greater crosswind speeds, translational lift effects become more dominant.

Performance reduction in tailwind conditions (blowback of hot exhaust gases into the exhaust system) is not modeled in the simulation.

When calculating wind corrections for maximum hover weight, consider that wind speed and direction may vary during takeoff/landing. Assume the lowest maximum hover weight corresponding with possible wind variance.

If wind conditions cannot be determined, assume poor hover conditions of 4-6 m/s tailwind.

*EXAMPLE:*

[Fig. 8.2](#) includes a solution (orange arrows) to the following example problem: determine the maximum hover weight for vertical takeoff in ground effect from an airfield located at an altitude of 2,300 m and +30°C FAT.

*SOLUTION:*

Using the IGE maximum hover weight chart [Fig. 8.2](#), enter the graph from the left at the point of the desired pressure altitude of 2,300 m. Draw a line horizontally to intersect the desired temperature of +30°C. From the intersection point, draw a vertical line down to find the maximum hover weight value, in this case 11,680 kg.

To determine the maximum takeoff weight for a vertical takeoff out of ground effect, perform the same process using the OGE maximum hover weight chart [Fig. 8.1](#).

*MAXIMUM TAKEOFF WEIGHT FOR A RUNNING TAKEOFF:*

To determine the maximum takeoff weight for a running takeoff, utilize the IGE maximum hover weight chart [Fig. 8.2](#), but add an additional 500 kg to the solution. Prior to performing a running takeoff, execute a test hover to an altitude of no less than 1 m to verify correct maximum weight calculation.

*MAXIMUM TAKEOFF WEIGHT FOR A NOSE WHEEL RUNNING TAKEOFF:*

Use nose wheel running takeoff maximum takeoff weight chart [Fig. 8.3](#) to determine the maximum takeoff weight for a nose wheel running takeoff.

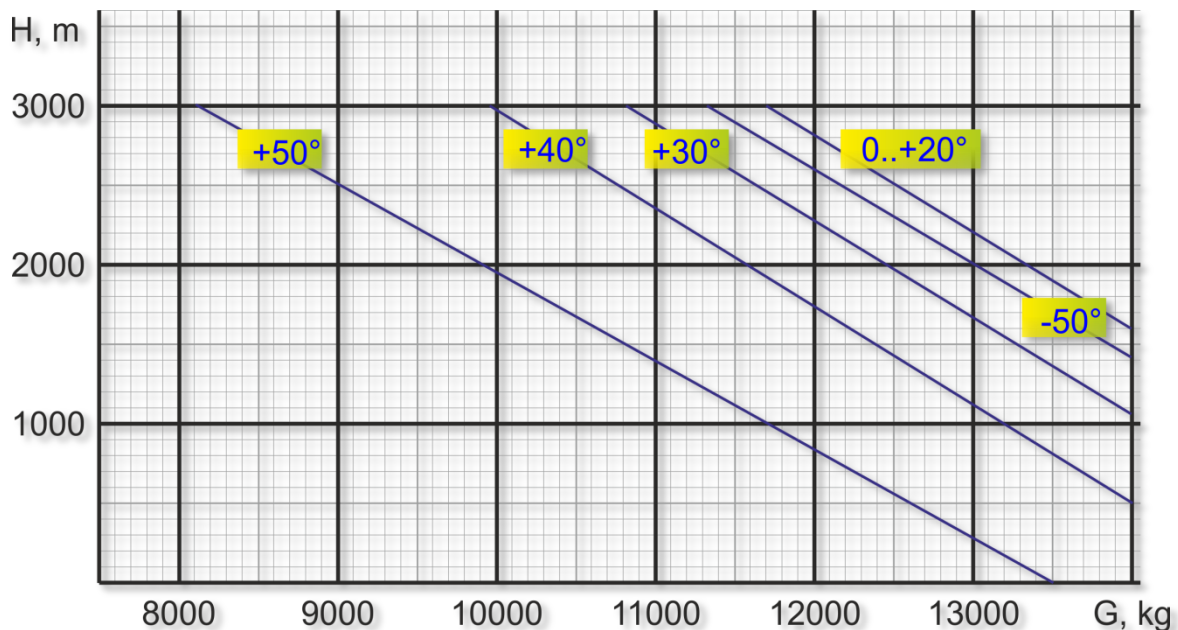

**Fig. 8.3. Nose wheel running takeoff maximum takeoff weight chart**

Execute a test hover to verify correct maximum weight calculation prior to performing a nose wheel running takeoff. The takeoff can be performed if the helicopter is able to lift off the ground during the test hover.

In all cases, the maximum takeoff weight should never exceed the helicopter maximum gross weight of 13,000 kg.

To calculate fuel and cargo weight limitations, individual helicopter component weights are provided in the [Table 8.1](#):

**Table 8.1**

No	Mi-8MTV2	May be	Weight, included in simulation model (as "equipped empty weight ")
1	Empty helicopter weight	7200	
2	Cabin ladder	7.3	7.3
3	Safe	4.5	Not modeled
4	Auxiliary fuel tank	70	Not modeled
5	Troop seats (30)	58.7	58.7
6	Cargo ramps	31.6	Not modeled
7	ЛПГ-150м (LPG-150M) hoist	33.5	33.5
8	Mounts for assault rifle	19.8	19.8
9	Waste equipment	93.6	Not modeled
10	Assault ropes	6	Not modeled
11	Unusable fuel	20	20
12	Main fuel 0.775 kg/L		
	- service tank	322	counted in the mission editor
	- main tanks	1608	counted in the mission editor
	- auxiliary tanks	1388	Not modeled
13	Armor plating	419	419
	- cockpit	332	
	- cargo cabin	33	
	- hydraulics compartment	54	
14	Weapons stations racks	401	401
15	Nose PKT 7.62-mm machine gun w/ ammo	38.8	Not modeled
16	Tail PKT 7.62-mm machine gun w/ammo (3 box at 250 cartridges)	26.9	counted in the mission editor
17	Door Machine gun 'KORD" 12.7-mm with mounting device and on-board ammunition supplies (12 box at 50 cartridges)	138	counted in the mission editor
18	UV-26 (self-defense EW system) with 128 flares	26.3	26.3
19	B8-V20A launchers w/t ammo	100	counted in the mission editor
20	Rockets (20 x 80-mm S-80M)	242	counted in the mission editor
21	GUV-1 (12.7-mm +7.62-mm machine gun)	452	counted in the mission editor
22	GUV-1 (30-mm grenades)	274	counted in the mission editor
23	UPK-23-250 (23-mm mashin gun)	230	counted in the mission editor
24	Minelaying container (empty)	70	Not modeled
25	Crew O <sub>2</sub> equipment	19.3	Not modeled
26	Rope ladder	19.7	Not modeled
27	PKV sight	2.5	2.5
28	OPB-1r sight	8.2	Not modeled
29	Junction box of weapon with Bombing	15.9	15.9

	weapon Control Panel		
30	Rescue equipment:	216	Not modeled
	- LPG-300 hoist	60	
	- hoist installation	95.5	
	- Junction box with fixing system	15.6	
	- spot light	20.5	
	- rescue basket	30	
	- boat-hook	0.9	
	- hand spot light (2)	2	
	- rescue belt (2)	4	
	- crew cheif belt	1.8	
	- rubber mat	6.6	
	- rescue seat	9	
	- other	5.4	
31	External sling system:	160.5	160.5
	- keylock DG-64M	21.3	
	- Safeguard (skirt) of bottom flap	9.3	
	- main ropes (4x1.11m)	10	
	Releasable components:	119.9	
	- sling cable type 1.7m	3.15	
	- sling cable type 5m	7.3	
	- sling cable type 10m (2)	27.3	
	- sling cable type 20m (2)	52.5	
	- lower strap (4x4m), or cargo hook	24	
	- minor components	5.6	
32	Rotor blade mooring equipment	43.3	Not modeled
33	L166V1A (self-defense EW system)	25	Not equipped
	<b>Total equipment weight, kg</b>		<b>1164.5</b>
34	Lubrication oil	71.7	71.7
35	Crew of three	270	270
	<b>Total helicopter weight (oil, crew) WITHOUT fuel and armament, kg</b>		<b>8706.2</b>

## 8.2. Calculating flight range, radius, and time

This section provides the required data for calculating flight navigation planning.

Flight range (radius) and flight time depend on fuel quantity and consumption rate, which in turn depends on helicopter weight, payload (which affects aerodynamic performance (in particular drag)), flight altitude and airspeed.

The effects of these factors on flight distance and time are examined below.

*ALTITUDE.* Helicopters are generally flown at low altitudes. However if long range operations are required, flight at altitudes of 2000 - 3000 m result in approximately 15% greater range than low altitudes.

*AIRSPPEED.* Greatest flight range is achieved at or near optimum cruise speed ( $\pm 20$  km/h)

*CRUISE SPEED* – optimum speed that provides greatest flight range (minimum fuel consumption rate) is provided in Table 8.2.

**Table 8.2**

Altitude, m	Helicopter weight 11 100 kg or less		Helicopter weight greater than 11 100 kg	
	Airspeed (km/h)			
	indicated	true	indicated	true
100	230	233	215	219
500	225	233	210	218
1000	220	233	205	218
2000	210	234	195	218
3000	195	230	160	190
4000	170	213	120	154
5000	120	163		
6000	100	145		

#### *AERODYNAMIC FACTORS*

When Exhaust IR suppression devices (7.12) are fitted, fuel consumption rates per kilometer and per hour provided in Table 8.4 increase by 6%.

With armament fitted, fuel consumption rates are as indicated in Table 8.4.

#### *ENGINE AIR BLEED FACTORS*

With anti-icing and particle separator system engaged, fuel consumption rates indicated in the tables below increase as follows:

- engine anti-icing: 3%
- main and tail rotor anti-icing: 2%

With the PZU particle separator system engaged, fuel consumption rates per hour provided in Table 8.4 increase by 3%.

#### *MINIMUM FUEL QUANTITY*

To ensure flight safety, a minimum fuel quantity is provided, which equals 260 L for the Mi-8MTV2.

*GROUND RUNUP FUEL CONSUMPTION* ( $G_{T3}$ ) includes:

- fuel required for engine start, warm-up, and taxi: 30 kg/5 min (6 kg/min)
- fuel required by the APU while powering the electrical systems prior to engine start: 1.25 kg/min)

*GROUND TARGET ATTACK RUNS* consume 12 kg of fuel/min on the first run. With 4-minute repeat attack runs, each is estimated to consume 50 kg, which is equivalent to a reduction of flight radius by approximately 10 km.



Fuel consumption rates required from takeoff to altitude are provided below in [Table 8.3](#) (nominal engine power setting).

Fuel consumption, distance, and time required from takeoff to altitude:

**Table 8.3**

Altitude, m	Indicated airspeed, km/h	Helicopter weight, kg								
		11000			12000			13000		
		Fuel consumption, kgf	Distance, km	Time, min	Fuel consumption, kgf	Distance, km	Time, min	Fuel consumption, kgf	Distance, km	Time, min
Takeoff and climb	-	15	-	1	15	-	1	15	-	1
100	120	20	-	1.5	20	-	1.5	20	-	1.5
500	120	25	-	2	30	-	2	30	-	2
1000	120	35	4	2.5	40	5	3	40	5	3
2000	120	55	7	4	60	9	4.5	70	10	5.5
3000	110	75	10	6	85	13	7	100	15	8
4000	110	95	15	7.5	115	19	9	140	30	11.5
4800	100	-	-	-	-	-	-	215	40	18
5000	100	115	20	9.5	155	27	13	.	.	.
6000	90	170	30	15	*	*	-	-	-	-

*FUEL CONSUMPTION RATES AT VARIOUS WEIGHT, ALTITUDES AND AIRSPEEDS FOR BOTH MAXIMUM RANGE AND DURATION'S LEVEL FLIGHT, see [Table 8.4](#)*

Per kilometer and per hour fuel consumption rates at various altitudes and airspeeds for maximum range depending on helicopter weight.

Main rotor RPM 95%

**Table 8.4**

H, m	Fuel consumption rate vs helicopter weight (kg)														
	9000			10 000			11 000			12 000			13 000		
	q, kgf/km	Q, kgf/hr	Qmin kgf/hr/ at Vind, km/h	q, kgf/k m	Q, kgf/h r	Qmin kgf/hr/ at Vind, km/h	q, kgf/km	Q, kgf/h r	Qmin kgf/hr/ at Vind, km/h	q, kgf/km	Q, kgf/ hr	Qmin kgf/hr/ at Vind, km/h	q, kgf/k m	Q, kgf/h r	Qmin kgf/hr/ at Vind, km/h
Transport configuration (w\o Weapons stations racks)															
100	2.66	620	445 / 120	2.69	627	470 / 120	2.75	641	495 / 120	2.84	621	520 / 110	2.93	640	550 / 120
500	2.55	593	445 / 120	2.6	605	455 / 110	2.67	621	485 / 110	2.76	601	515 / 110	2.84	623	545 / 110
1000	2.44	569	425 / 120	2.49	580	450 / 120	2.57	599	475 / 120	2.66	587	505 / 120	2.77	614	540 / 120
2000	2.24	525	400 / 100	2.33	546	425 / 100	2.42	572	455 / 110	2.56	559	490 / 130	2.72	592	530 / 120
3000	2.11	485	380 / 100	2.23	510	410 / 110	2.36	540	445 / 120	2.65	500	480 / 120	2.94	554	535 / 120
4000	2	426	370 / 100	2.14	455	400 / 110	2.36	502	445 / 120	3.23	487	495 / 120	3.85	575	580 / 110
5000	2.09	354	360 / 100	2.37	406	400 / 110	2.8	488	470 / 110						
Combat configuration (with Weapons stations racks) without armament															
100	2.75	643	445 / 100	2.81	660	475 / 100	2.87	676	500 / 115	2.95	651	530 / 120	3.03	673	555 / 120
500	2.67	630	435 / 110	2.73	646	460 / 110	2.79	663	490 / 110	2.85	640	515 / 110	2.94	660	545 / 115
1000	2.55	613	425 / 110	2.6	629	450 / 110	2.66	648	480 / 110	2.75	627	505 / 110	2.9	651	540 / 110
2000	2.34	570	400 / 100	2.42	586	425 / 100	2.53	610	460 / 100	2.63	599	500 / 115	2.81	638	540 / 115
3000	2.21	515	385 / 105	2.29	540	415 / 115	2.44	581	445 / 120	2.7	527	490 / 120	3	579	550 / 120
4000	2.07	447	370 / 120	2.23	477	405 / 110	2.5	523	450 / 115	3.46	522	525 / 100	4.17	596	630 / 100
5000	2.12	375	360 / 100	2.45	431	415 / 100	3.03	507	520 / 100						
Combat configuration with armament															
100	2.83	692	450 / 110	2.91	697	480 / 115	2.99	706	505 / 115	3.07	673	530 / 110	3.15	686	560 / 120
500	2.75	679	440 / 110	2.83	681	460 / 110	2.91	684	490 / 110	2.99	649	520 / 110	3.07	662	550 / 115
1000	2.66	645	430 / 110	2.75	650	455 / 110	2.82	657	480 / 100	2.9	624	510 / 110	2.99	642	545 / 120
2000	2.45	586	405 / 100	2.52	593	433 / 100	2.6	607	465 / 110	2.7	594	505 / 130	2.86	625	550 / 120
3000	2.26	522	385 / 100	2.36	536	415 / 100	2.48	559	450 / 120	2.75	537	495 / 120	3.13	617	560 / 110
4000	2.12	464	375 / 120	2.28	481	405 / 110	2.6	548	455 / 110	3.65	553	545 / 100	4.5	684	695 / 110
5000	2.15	376	365 / 105	2.61	445	425 / 100	3.6	553	595 / 100						

q, kgf/km – fuel consumption in kg for 1 km; Q, kgf/hr – fuel consumption in kg per hour; Vind – indicated airspeed

*FUEL CONSUMPTION, DISTANCE, AND TIME REQUIRED IN LANDING APPROACH*
**Table 8.5**

Starting altitude, m	Indicated airspeed, km/h	Descent rate, m/s	Fuel consumption, kgf	Distance, km
Deceleration, hover, and landing	—		15	1
100	120—130	2-4	20	—
500	140—150	5-6	25	5
1000	140—150	5-6	30	10
2000	140—150	5—6	45	20
3000	140—150	5-6	60	30
4000	120	3—4	90	40
5000	120	3-4	130	55

*FUEL CONSUMPTION PER HOUR IN HOVER (KGF/HR) OUT OF GROUND EFFECT*
**Table 8.6**

Helicopter weight	Fuel consumption per hour (kgf/hr) vs airfield altitude, m				
	0	500	1000	2000	3000
9000	700	660	640	630	610
10000	730	710	700	690	690
11000	790	770	770	760	—
12000	850	840	840	—	—
13000	920	920	—	—	—

To calculate the required fuel for a given mission range, calculate the fuel required for non-navigation phases of the mission (start, taxi, target attack run(s)), add the minimum fuel quantity, then subtract this sum from the total fuel quantity on board. Multiply the remainder by 0.95 to add 5% navigational error factor and another 0.95 to add 5% for formation keeping.

### ***8.3. Engines and transmission limits***

#### **8.3.1. Engines limits**

TV3-117VM Maximum Operating Limits (all Altitude, all Ambient temperature) see in Table 8.7

**Table 8.7**

Power setting	MAX PTIT (°C)	MAX N1 (%)
Max Rated	990	101.0
Take Off	990	101.0
MAX LTD Cruise	955	99.0
LTD Cruise	910	97.5
Cruise	870	95.5
IDLE	780	See <a href="#">Fig. 4.3</a>

TV3-117VM operating range see in Table 8.8

**Table 8.8**

POWER SETTING	RPM			Oil Pressure (kgf/cm <sup>2</sup> )	Oil Temp °C				MAX Time Allowed, minutes
	N1	Nr			MAX	recommended	MIN Oil Temp Continuous Operation	MIN Initial Oil Temp	
		One operating engine	Two operating engines						
IDLE	See <a href="#">Fig. 4.3</a>	40-55	55-70	>2					20
CRUISE	in accordance with the <a href="#">IR-117</a> , <a href="#">Fig. 8.4</a> , but does not exceed the values of the <a href="#">Table 8.7</a>	95 ± 2		3,5±0,5	150	80-140	70	30	No limit
LTD CRUISE		95±2		3,5±0,5	150	80-140	70	30	No limit
MAX LTD CRUISE		95±2		3,5±0,5	150	80-140	70	30	60
TAKE OFF		93±1		3,5±0,5	150	80-140	70	30	6
MAX RATED*		93±1		–	3,5 ±0,5	150	80-140	70	30

\*When one engine has failed, the operating engine automatically elevates power to MAX Rated available. MAX Rated Power operating mode can not be activated for both engines simultaneously.

Other translate: MAX Rated Power operating mode one of two engine can be activated only when the other engine failure (ie any action of the crew with (for) two simultaneously operating engines can not be set MAX Rated Power).

\*\*Exceeding 6 minutes of operating time in the EMER (MAX RATED) /Take Off settings or the time limits for other power settings, will result in a reduction in engine service life.

N1% Limits Adjusted for Ambient Temperature see in [Fig. 8.4](#)

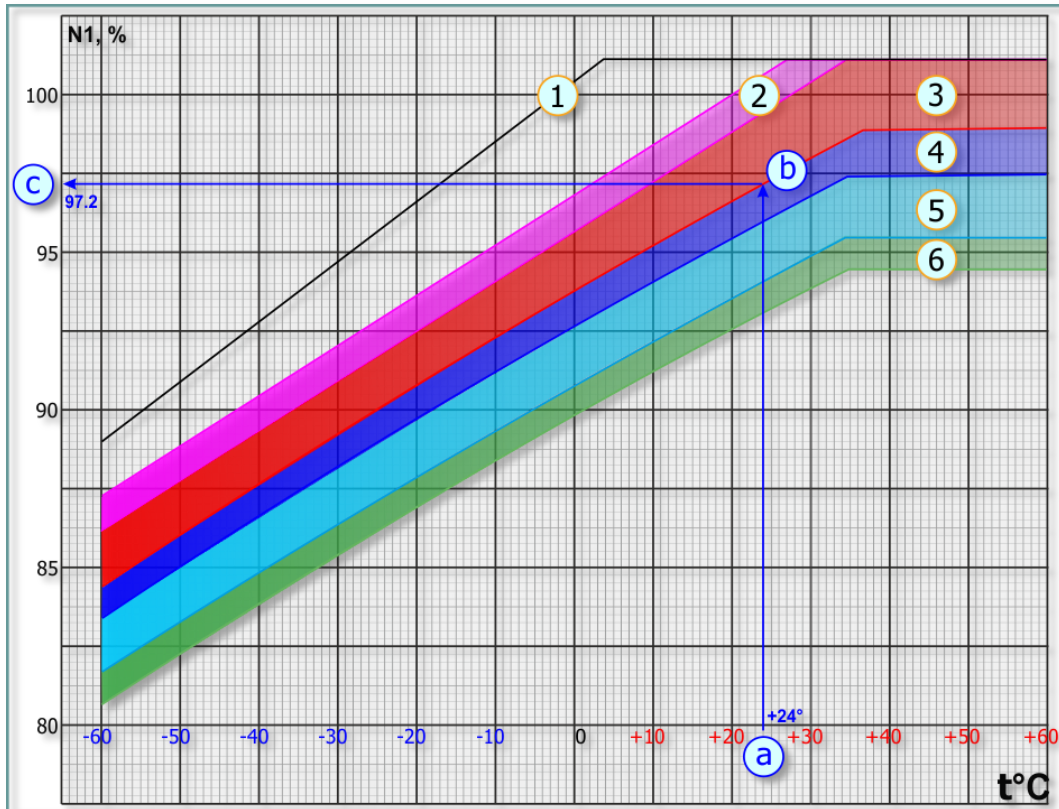

**Fig. 8.4. N1% Limits Adjusted for Ambient Temperature**

- |  |                              |
|--|------------------------------|
| 1. Maximum allowed N1 at standard atmospheric pressure | 4. MAX LTD CRUISE Power area |
| 2. MAX RATED Power area                                | 5. LTD CRUISE Power area     |
| 3. TAKE OFF Power area                                 | 6. CRUISE Power area         |

Example. Determine Maximum and Minimum N1 of Take-Off Power Setting mode for Ambient Temperature at +24°C.

Key (for Minimum N1): enter the graph from the bottom applying the reported ambient temperature (+24, a). Proceed vertically to the MIN Take Off power setting diagonals (b). Continue from the intersecting point to the left to obtain the Minimum N1 (97.2%, c). Maximum N1 is 99.4%.

NOTE. This chart applies to standard atmospheric pressure. Apply the N1% established in this chart to [Fig. 8.5](#), N1 Adjusted for Barometric Pressure to find the N1 for the power setting required.



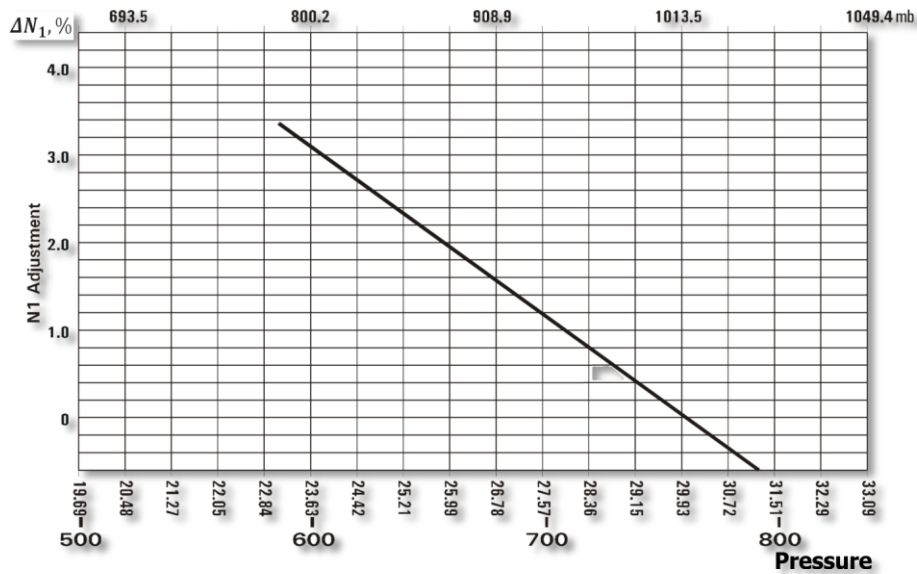

**Fig. 8.5. N1% Adjusted for Barometric Pressure**

### 8.3.2. Transmission limits

#### Main Transmission Maximum Operating Limits:

a) oil pressure:

- IDLE mode – > 0,5 kg/sm<sup>2</sup>;
- other Power Setting mode – 3.5±0,5 kg/sm<sup>2</sup>;

b) oil temperature:

- MAX 90°C;
- recommended 50 - 80°C;
- MIN Initial Oil Temp (for operating more IDLE) –15°C;
- MIN Oil Temp Continuous Operation +30°C.

c) Main Rotor RPM limitations see Table 8.9

**Table 8.9**

Absolute Limits:	RPM, %	MAX Time Allowed
MAX Rated & Take-Off Power	103%Maximum	10 Seconds
MAX Rated & Take-Off Power	88% Minimum	30 Seconds
All Settings above LTD Cruise	101%Maximum	20 Seconds
All Settings below LTD Cruise	103%Maximum	20 Seconds
Normal Operating Limits:	RPM, %	MAX Time Allowed
IDLE	55 to 70 (40 to 55 Single Engine)	20 Minutes
CRUISE	97% Maximum	Not Limited
LTD CRUISE	97% Maximum	60 Minutes
MAX LTD CRUISE	97% Maximum	60 Minutes
TAKE OFF	94% Maximum	6 to 15 Minutes
MAX RATED POWER	94% Maximum	6 to 60 Minutes

MAX oil temperature in **Intermediate gearbox** and **Tail rotor gearbox** is 110°C.





**9**

***NORMAL PROCEDURES***



## 9. NORMAL PROCEDURES

The automatic start-up procedure can be activated by pressing **LWIN + HOME**. Automatic shut down can be activated by pressing **LWIN + END**.

Below contains steps in two variants: *SIMPLIFIED PROCEDURE* (the minimum necessary action) and a *FULL PROCEDURE* (full set of actions). In addition, if any item (in table) can be skipped, it is marked by \*

### 9.1. Preflight cockpit check

#### 9.1.1. Simplified procedure

Ensure the controls are properly set for start:

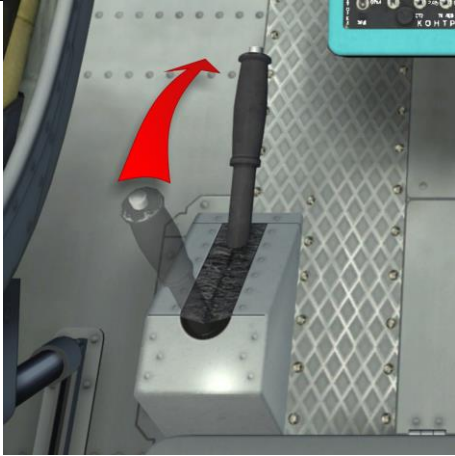
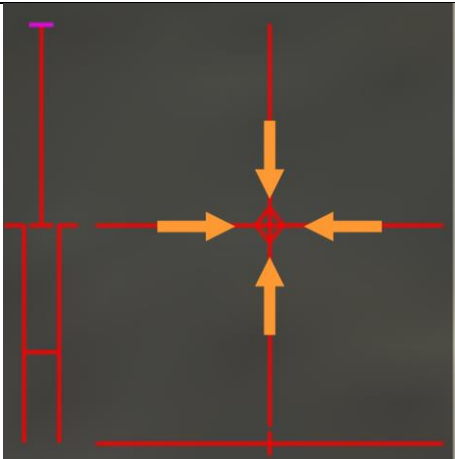
1. Rotor brake – DOWN (unlock) <b>RCtrl + R</b>	
2. Cyclic - CENTER <b>← → ↑ ↓</b> For activate indicator <b>LCtrl + Enter</b>	
3. Collective- DOWN <b>Num -</b>	

4. Throttle – FULL LEFT (Idle Power) **PgDn**



5. Engine Power Levers – MIDDLE (standart power setting for normal operation)

**RCTRL + HOME** / **RCTRL + END**



### 9.1.2. Full procedure

Perform the following cockpit checks prior to flight:

- Make sure that the braking system is leak-free and operates normally (after depression of the brake handle and attainment of a pressure of 31 to 34 kg/cm<sup>2</sup> in the brake line there should be no noise created by outgoing air and, after releasing the brakes, there should be no residual pressure in the brake system) **W**

- Set the pressure altimeter pointers to zero and check the barometric pressure display for compliance with the actual aerodrome pressure with an accuracy of  $\pm 1.5$  mm Hg [LShift + B] / [LCtrl + B]
- energize the helicopter electrical systems
- check crew intercommunication over the SPU-7 ICS (in case multicrew game)
- check windshield wiper operation
- check and set the clock;
- check fuel quantity on the fuel gauge and set the fuel gauge selector to "PACX" (SVC CELL) [2] (move to the co-pilot's seat), [RCtrl + RShift + V] for CW turn [RCtrl + RShift + B] for CCW turn.
- release the rotor brake [RCtrl + R] (down)
- make sure the collective pitch control lever is at the lower stop [Num -] and the throttle control twist grip is turned fully to the left [PgDn], the engines throttle levers are set in the neutral detent [RCTRL + HOME / RCTRL + END], the control stick is in a position close to neutral and the fuel shutoff levers are in the aft (closed) position [RCtrl + PageUp.. PageDown]

## 9.2. Preparation and equipment check procedures preceding APU start

The power supply is required to start the APU. APU start can be made with or using batteries (A), or an external power supply (B).

### 9.2.1. Simplified procedure

#### A. Turn on onboard electrical power:

##### 1. Right Side Panel - DC POWER:

АККУМУЛ I, II (Battery 1, 2) – ON (UP), check the voltage of the battery bus by setting the DC selector knob to "ШИНЫ АКК." (BATT BUS). The voltage should be no less than 24 V.

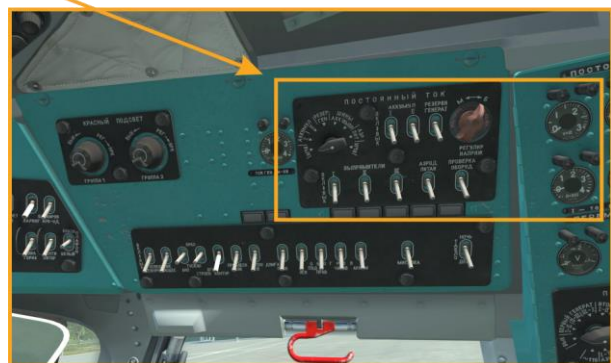



2. Right rear console – AC: ~115 (inverter 115V) – set to "РУЧНОЕ" (MANUAL) (needed for manometers and TV3-117VM exhaust gas temperature gauges operation).

Note. When doing cold start from batteries, to prevent them from fast discharge, it is recommended to leave the 36V inverter switch in neutral position, until generators are operating.



3. Left and Right Circuit Breaker Panels:



All circuit breakers - ON **CTRL + RSHIFT + 4... 9** (1..3 for Weapon System)

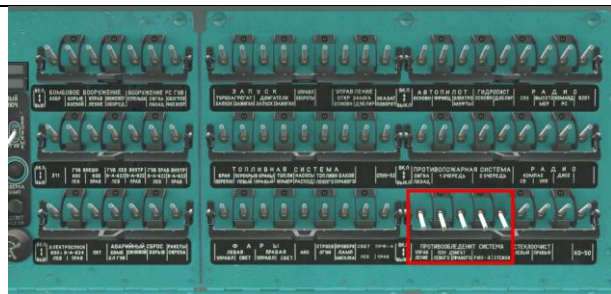

4. ПРОТИВООБЛЕДНЕНИЕ (Anti-ice Control, Left Engine, Right Engine) circuit breakers – OFF (unless required)

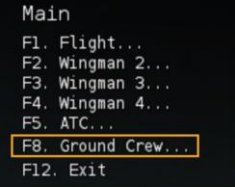
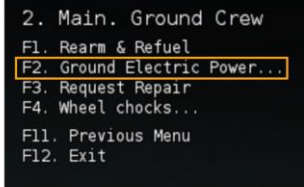
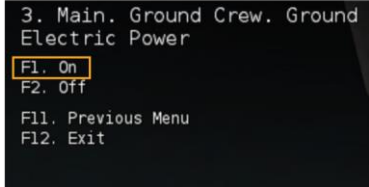

**B. Connecting to external electrical power:**

<p>5.  (Radio Menu),  ,  (Connect Ground Electric Power).</p>	  
<p>6. Once the "АЭР. ПИТ. ВКЛЮЧЕНО" (EXT PWR ON) light illuminates (after successful connection to an external power source), and check the DC ground power source voltage by setting the DC selector knob to "АЭРОДРОМ. ПИТАН." (EXT PWR). The voltage should be within the limits of 27 - 29 V.</p>	 
<p>7. Follow the procedures, described in the chapter A</p>	

### 9.2.2. Full procedure

While performing complete preparation procedure, one must connect power sources and continue extensive control and preparation of equipment for start.

#### *Connection of power supplies*

A. Turning on the batteries:

- "АККУМУЛ. I" и "II" (BATT I, II) to "ВКЛ." (ON (up)) ;
- check the voltage of the battery bus by setting the DC selector knob to "ШИНЫ АКК." (BATT BUS). The voltage should be no less than 24 V.
- check the condition of the batteries as follows:

- a) "АЭРОДР. ПИТАН." (EXT PWR (external power)) selector to "ВЫКЛ." (OFF) **[LCtrl + LShift + 7]**;
- b) DC selector knob to "АККУМУЛ. I" (БАТТ I) **[LCtrl + LShift + 9..0]**
- c) "АККУМУЛ. II" (БАТТ II) to "ВЫКЛ" (OFF (down)) **[LCtrl + LShift + 2]**
- d) any fuel boost pump to ON and check Volts (no less than 24 V) **[RShift + 1]**
- e) DC selector knob to "АККУМУЛ. II" (БАТТ II) **[LCtrl + LShift + 9..0]**
- f) АККУМУЛ. II" (БАТТ II) to "ВКЛ" (ON (up)) **[LCtrl + LShift + 2]** and "АККУМУЛ. I" (БАТТ I) to "ВЫКЛ" (OFF (down)) **[LCtrl + LShift + 1]** Check voltage (no less than 24 V).
- g) fuel boost pump to OFF **[RShift + 1]**;
- h) "АККУМУЛ. I" и "II" (БАТТ I, II) to "ВКЛ." (ON (up)) **[LCtrl + LShift + 1..2]**;
- i) DC selector knob to "ШИНЫ АКК." (БАТТ BUS) **[LCtrl + LShift + 9..0]**.

## B. Connecting to external electrical power:

To connect to an external power source on the ground:

- *DC EXTERNAL POWER*: once the "АЭР. ПИТ. ВКЛЮЧЕНО" (EXT PWR ON) light illuminates, then **[LCtrl + LShift + 7]**, check the DC ground power source voltage by setting the DC selector knob to "АЭРОДРОМ. ПИТАН." (EXT PWR). The voltage should be within the limits of 27 - 29 V.
- *AC EXTERNAL POWER* (in DCS this occurs simultaneously with the DC power supply): once the "АЭР. ПИТ. ВКЛЮЧЕНО" (EXT PWR ON) light illuminates (after successful connection to an external power source), then **[LAlt + LShift + `]**, check the ground power source voltage by setting the AC selector knob to "АЭРОДРОМ. ПИТАН." (EXT PWR). The voltage should be within the limits of 200 – 205 V. Set the "АЭРОДРОМ. ПИТАН." (EXT PWR) switch to "ВКЛ." (ON). Set the "ПО-500А ~ 115" (Inverter 1) and "ПТ-200 ~ 36" (Inverter 2) switches to the "АВТОМАТ" (AUTO) (down) position. Set the "ВЫПРЯМИТЕЛИ I, II, III" (RECTIFIERS 1, 2, 3) to the "ВКЛ." (ON) (up) position. Check the rectifier bus voltage by setting the DC selector knob to "ШИНЫ ВЫПР." (RECT BUSES). The voltage should be within the limits of 27 - 29 V.
  - set the AC selector knob to the "~115" position. The voltage should be 115 V.
  - Set the "АЭРОДР. ПИТАН." (EXT PWR) switch to "ВКЛ." (ON) and the Inverter 115 switch to "РУЧНОЕ" (MAN).
  - Check the inverter output voltage by setting the AC selector knob to "~115". The voltage should be 115 V.

### ***Equipment preparation and check procedures, continued***

- switch ON all the circuit-breakers and switches required for starting the APU and main engines (the starting system, ignition systems for the APU and main engines, fire protection system, hydraulic systems, trim actuators, fuel tank pumps, fuel quantity gauge, engine anti-icing system, friction clutch, electric clutch, gyro correction cutout switch, attitude indicator, directional gyro, autopilot, voice warning system, tail rotor pitch limit system, cockpit voice recorder, anti-collision light **[RCTRL + RSHIFT + 1... 9]**)
- make sure the AC generator switches are set to "ВЫКЛЮЧЕНО" (OFF) (down) **[LAlt + LShift + 1..2]**
- make sure that РИ-65 (RI-65) switch is in the ВЫКЛ. (OFF) position and the corresponding light panel ВКЛЮЧИ РИ-65 (ENABLE RI-65) is on;
- make sure that the СПУУ-52 (SPUU-52) switch is in the ВЫКЛ. (OFF) position and the corresponding red light-button on the center console is on;
- check that helicopter has enough fuel, using fuel meter, after check procedure, set the switch to the "РАСХ." (FEED TANK) position (player must take the co-pilot seat) **[RCtrl + RShift + V]** rotation clockwise, **[RCtrl + RShift + B]** rotation counterclockwise;
- check that squibs of the fire extinguishers and fire signalization system are operational according to the procedure described in the chapter [7.6.3](#)

For night time operations:

- flashlight **[LAlt + L]** (mouse control)
- turn on red lighting of the instrument and control panels according [7.8.2](#)
- turn on the navigation lights **[RCtrl + 1..2]** (dimmed), the MSL-3 flasher **[RCtrl + 6]** and rotor tip lights **[RCtrl + 5]** (they must be turned on for safety of the ground crew, in game it is not necessary).

### ***9.3. Starting the APU and main engines***

After preflight cockpit check and energizing electrical power sources, is required preparing for APU and main engines start:



### Final procedures before APU start

1. Set the selector knob of TEST fire signal chanel switch to "ВЫК" (OFF), then "КОНТРОЛЬ ДАТЧИКОВ – ОГНЕТУШЕНИЕ" (FIRE EXT/TEST) switch to "ОГНЕТУШЕНИЕ" (EXT) (up, light out)

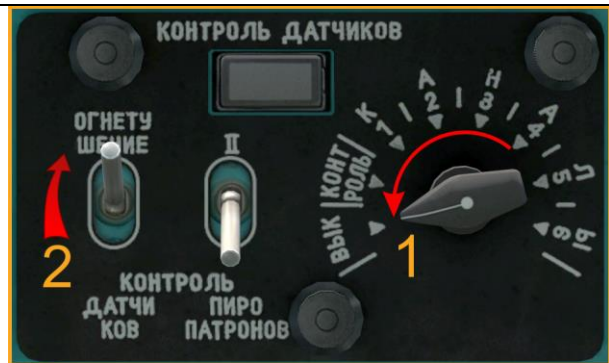

2. Switch on the fuel boost pumps **[RShift + 1]** of the service tank and the fuel transfer pumps of the main tanks **[RShift + 2..3]**

Note. When performing cold start from batteries, to save batteries, it is recommended to not enable transfer pumps, until APU generator or rectifiers are operational.

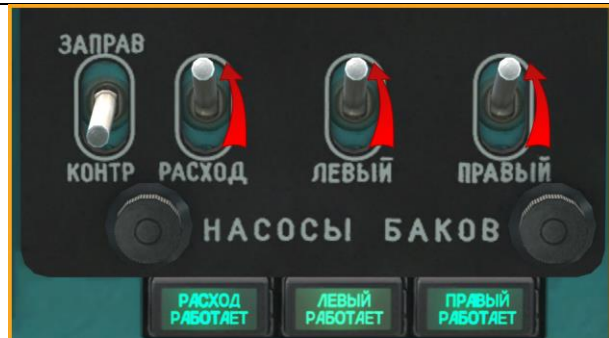

NOTE. If during APU start will used battery only, then it necessary fuel transfer pumps of the main tanks set OFF

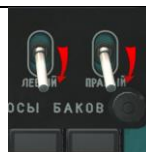



3. Open the fuel fire (shutoff) valves (UP) **[LAlt + 5..6]** then **[RAlt + 5..6]**



- \*switch on the command radio and request clearance for engine start

### Starting the AI-9v APU

Start the APU prior to starting the main engines:

1. "ЗАПУСК- ПРОКРУТ.- ЛОЖНЫЙ ЗАПУСК" (START-CRANK-FALSE START selector on the APU start control panel to "ЗАПУСК" (START) (UP) **[RCtrl + E]** / **[RAlt + E]**



2. Press the "ЗАПУСК" (START) button for 2 to 3 seconds **[RShift + Home]**. The "АВТОМАТ. ВКЛЮЧЕН" (AUTO IGNITION) light should illuminate. The APU automatically accelerates to idle speed, indicated by illumination of the "ДАВ. МАСЛ. НОРМА" (OIL PRESS NORM) and "ОБОРОТЫ НОРМА" (NORMAL SPEED) lights. The time to reach idle speed should not exceed 20 seconds.

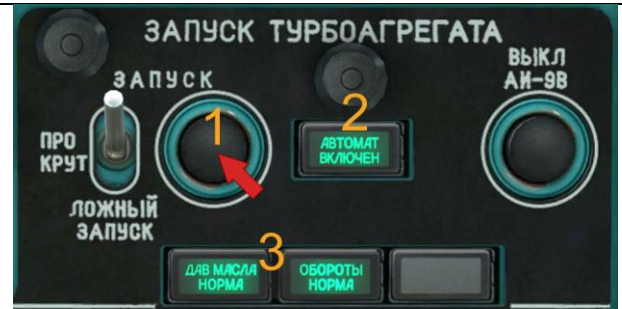

Once the APU reaches idle speed, check its operational parameters and make sure:

- continuous idle EGT does not exceed 720°C;
- "ДАВ. МАСЛА НОРМА" (OIL PRESS NORM) and "ОБОРОТЫ НОРМА" (NORMAL SPEED) lights illuminate;
- air pressure reading in the APU main air bleed line (APU pressure gauge) is within normal parameters (1.3-2.0 kg/sm<sup>2</sup>);



- "РЕЗЕРВН. ГЕНЕРАТ." (STBY GEN) switch is set to "ВЫКЛ." (OFF) (down) **[LCtrl + LShift + 3]**



The APU must run for a minimum of 1 minute before attempting to start the main engines.

In case of an inadvertent shutdown of the APU, press the "ВЫКЛЮЧЕНИЕ АИ-9В" (APU OFF) button for 2 to 3 seconds in order to cut off fuel supply to the APU **[End]**.

The APU start can be aborted at any time by pressing the "ВЫКЛЮЧЕНИЕ АИ-9В" (APU OFF) button for 2 to 3 seconds.

In case of an unsuccessful APU start, crank the APU as follows:

- set the "ЗАПУСК – ПРОКРУТ. – ЛОЖНЫЙ ЗАПУСК" (START-CRANK-FALSE START) selector switch to (CRANK) **[RCtrl + E]** / **[RAlt + E]**;
- press the "ЗАПУСК" (START) button **[RShift + Home]** and check that the "АВТОМАТ. ВКЛЮЧЕН" (AUTO IGNITION) and "ДАВ. МАСЛА НОРМА" (OIL PRESS NORM) lights illuminate.

Restart attempts must be 3 minutes apart. Three attempts can be made. If the unit does not start after three attempts, a 15 minute shut-down/cooling period must follow before another start is attempted.

Continuous APU operation is limited to 30 minutes. In "РЕЗЕРВН. ГЕНЕРАТ" (STANDBY/GEN) mode, the APU cannot be operated beyond 30 minutes, after which a 15 minute shut down/cooling period is required. Cool down the APU 15 minutes between shutdown and restart. Run the APU a minimum of 1 minute before shutdown.

Three consecutive attempts to start the main engines via APU bleed air are allowed. The duration of each air bleed cycle should not exceed 45 seconds with intervals between the air bleed cycles no less than 1 minute, during which the APU is run at

idle speed. The continuous running time of the APU in this condition should not exceed 13 minutes, followed by a 15 minute shut down/cooling period.

Do NOT start the main engines with the APU in DC generator mode (STBY GEN switch on the right side console ON (up)).

### Starting the TV3-117VM Main Engines

The engines starting order depends on the wind direction. The engine on the downwind side is started first.

1. Set the start mode selector switch to "ЗАПУСК" (START) **[LShift + E]** and the "ЛЕВ. – ПРАВ." (LEFT - RIGHT) engine selector switch to the desired engine for start (downwind first, upwind second) **[RAlt + RShift + E]** / **[RCtrl + RShift + E]**



2. Press the "ЗАПУСК" (START) button for 2 to 3 seconds to initiate the start sequence **[Home]**.





3. Open (set forward) the fuel shutoff lever of the engine being started when N1 (compressor) RPM begins to rise **[RCtrl + PgUp]** (left) / **[RCtrl + PgDn]** (right)

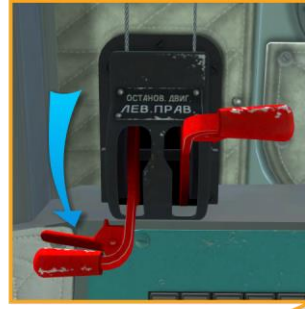

4. The engine should reach idle speed within 60 seconds. The "АВТОМАТ. ВКЛЮЧЕН" (AUTO IGNITION ON) and "СТАРТЕР РАБОТАЕТ" (STARTER ON) lights should illuminate during the start.





5. If engine startup is performed with use of onboard batteries only, then after the first engine has been started, connect onboard power consumers to the APU generator by setting the "РЕЗЕРВН. ГЕНЕРАТ." (STANDBY GENERATOR) **[LCtrl + LShift + 3]** и "ПРОБЕРКА ОБОРУД." (EQUIPMENT TEST) **[LCtrl + LShift + 8]** into the "ВКЛ." (ON) positions.



After completion of the automatic starting cycle the lights should turn off (AUTO IGNITION ON light in 30 seconds; STARTER ON light upon N1 RPM reaching 60-65%).

Unusual thumps or impact noises during main engine start and rotor spin up indicate the main rotor blades centrifugal droop limiters are hitting their stops. Carefully adjust the cyclic control stick position until the noise is eliminated.

Set the "ЛЕВ. - ПРАВ." (LEFT - RIGHT) engine selector switch to the second starting engine (upwind side) **[RAlt + RShift + E]** / **[RCtrl + RShift + E]** and repeat the starting procedure for the second engine.

With both engines started and running at idle speed, the Nr (main rotor) RPM should stabilize within 55-70%.

**Immediately after starting the engine ..**

6. Switch on the PZU particle separators for both engines by setting the "ПЗУ ДВИГАТ. ЛЕВ./ПРАВ." (PZU LH/RH) switches to the "ВКЛ" (ON (up)) position **[LCtrl + D]** / **[RCtrl + D]**. Check the "ЛЕВ. ПЗУ ВКЛЮЧЕН." (LH PZU ON) and "ПРАВ. ПЗУ ВКЛЮЧЕН" (RH PZU ON) lights to illuminate (for up to 30 seconds).

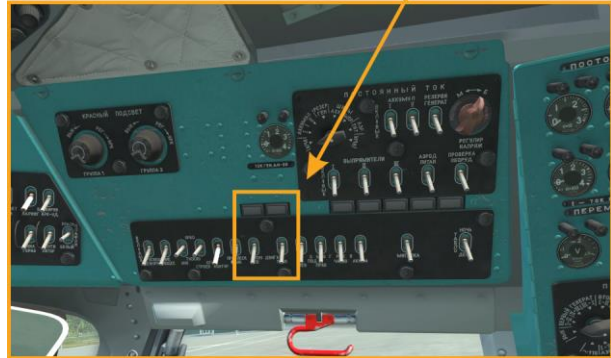
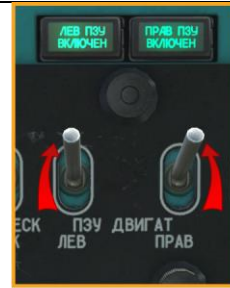

7. After successfully starting the main engines, allow the APU to cool down at idle speed for 0.5 - 1 min and shut the APU down by pressing the "ВЫКЛ АИ-9В" (APU OFF) button **[End]**.

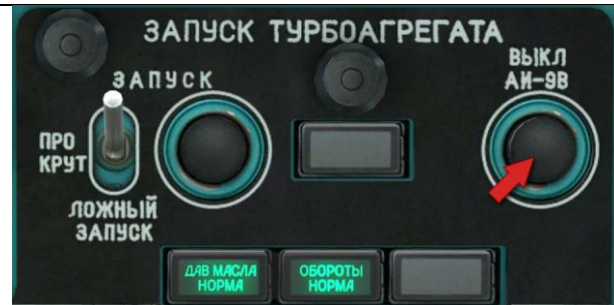

8. If engine startup is performed from batteries only, then do not turn the AI-9V until engines have been warmed up and main rotor has reached RPM of 88%. To supply onboard consumers during the idle mode and when the first engine has been started and second has not, enable the STG-3 (see phase 5.) generator by switching the "РЕЗЕРВН. ГЕНЕРАТ." (STANDBY GENERATOR) **[LCtrl + LShift + 3]** и "ПРОВЕРКА ОБОРУД." (EQUIPMENT TEST) **[LCtrl + LShift + 8]** to the "ВКЛ." (ON) positions. Note. If before APU start the transfer pumps were off, to safe batteries power, now it is time to enable them.



#### 9.4. Engines warm up, Flight controls and Hydraulic systems checks

Engine warm up is performed at idle power with collective lowered to minimum **[Num - ]**, throttle turned fully left **[PgDn]**, engine condition levers set in the idle detent (middle) position **[RCtrl + Home / RCtrl + End]**.

Monitor the powerplant instrumentation during engine warm up. Warm up should not exceed 1 minute.

Test the flight controls and hydraulic systems at idle power as follows:

- \*alternatively move the cyclic and pedals to make sure the controls move smoothly without jamming;
- \*as the controls are moved, the main hydraulic system pressure should vary within a range of  $45 \pm 3$  to  $65 \pm 8_2$  kg/cm<sup>2</sup>. Pressure in the reserve hydraulic system should be approximately 5 kg/cm<sup>2</sup>.

The throttle can be set from full left to full right to accelerate the engines out of idle power once the engine outlet oil temperature reaches +30°C and the main gearbox oil temperature reaches at least -15°C.

Additional checks at idle (for in-depth study of the helicopter):

1. Check the utility and standby hydraulic systems;
2. Check the engine anti-icing system at idle;
3. Check the electronic engine governor, using channels ST1 and ST2:
  - switch on the "ЭРД ЛЕВ. ПРАВ" (ELECTRONIC ENGINE GOVERNOR LEFT RIGHT);

- set the "КОНТРОЛЬ СТ-1 – РАБОТА – КОНТРОЛЬ СТ-2" (CHECK ST1 – OPERATION – CHECK ST2) into the "СТ-1" (ST1) position;
- gradually increase the main rotor RPM by twisting the throttle grip to the right (main rotor pitch should be in the lower stop position), if necessary, use the ECL handles, until the yellow warning panels "ПРЕВ. NCT ЛЕВ. ДВ" (EXCEEDING RPM LEFT ENGINE), "ПРЕВ. NCT ПРАВ" (EXCEEDING RPM RIGHT ENGINE) go on. It should happen when  $Nr_{(main\ rotor)} = 91.5 \pm 2\%$ ;
- gradually reduce Nr at  $5 \div 7\%$ , but not less than 88%, warning panels, mentioned above, should remain on;
- set the switch to the "СТ-2" (ST-2) position and repeat the check.  
WARNING: When switching from position "СТ-1" (ST-1) to "СТ-2" (ST-2) one must hold them in intermediate state for some time. Fast toggling from "СТ-1" (ST-1) to "СТ-2" (ST-2) can cause engines shut off (not implemented in the game).

## 9.5. Engine run up, switching ON generators and rectifiers. Avionics checks

### A. Switching ON generators and rectifiers

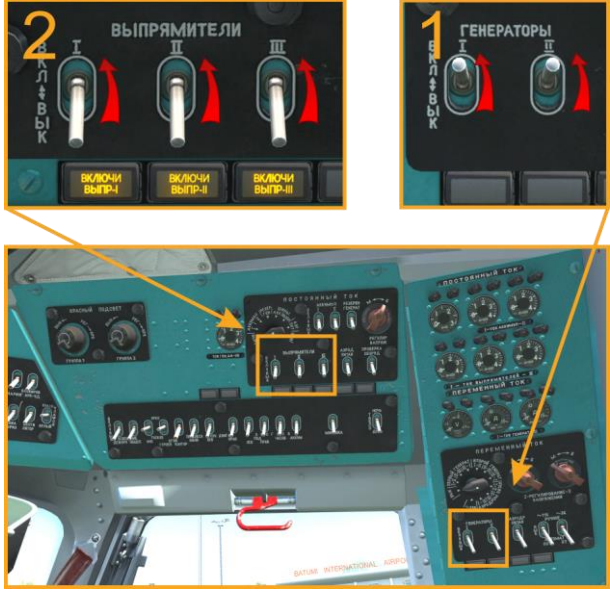
<p>1. Rotate the throttle full right <b>[PgUp]</b></p>	
<p>2. Set the AC generators 1 and 2 <b>[LAlt + LShift + 1..2]</b> and rectifiers switches (1..3) to ON <b>[LCtrl + LShift + 4..6]</b>.</p>	



3. Request external power to be switched off. When the "АЭР. ПИТ. ВКЛЮЧЕНО" (EXT PWR) light turns off, set the "АЭРОДР. ПИТАН." (EXT PWR) selector switches of OFF **[LCtrl + LShift + 7]**.



4. If APU generator was enabled, now it is time to turn it off, by setting the "РЕЗЕРВН. ГЕНЕРАТ." (STANDBY GENERATOR) **[LCtrl + LShift + 3]** и "ПРОВЕРКА ОБОРУД." (EQUIPMENT TEST) **[LCtrl + LShift + 8]** into the "ВЫКЛ." (OFF) positions and the disable the APU.

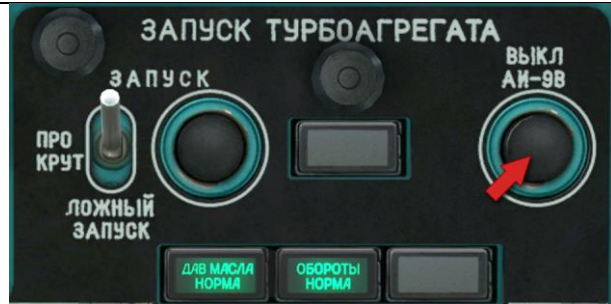

5\*. Check
 

- the AC generators output voltage to be within 200 to 205 V, **[LAlt + LShift + 7]** / **[LAlt + LShift + 8]**





- the rectifiers output voltage to be within 27 to 29 V, **[LCtrl + LShift + 9]** / **[LCtrl + LShift + 0]**

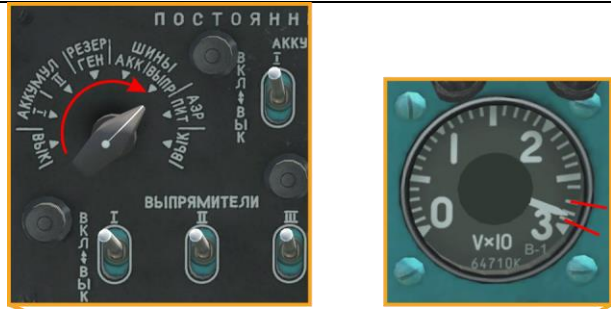

- the transformer output voltage to be 115 V.



6. Set (or check) the ПО-500 ~115 V (Inverter 1) **[LAlt + LShift + 3]** and ПТ-500 ~36 V (Inverter 2) **[LAlt + LShift + 5]** inverters to the АВТОМАТ (AUTO (down)) position.

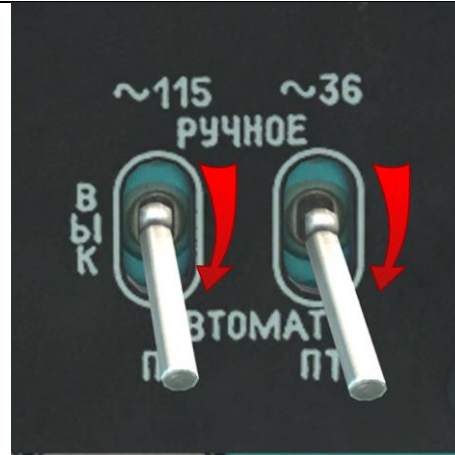

### Additional checks

at with fully opened (all the way to the right) throttle (for in-depth study of the helicopter):

1. Check the anti-icing system of the engines at right throttle. After 25-40 seconds from the moment when the system was enabled, can increase: the gas temperature in front of compressor's rotor (not more than 60°C) and  $N_{tc}$  (Turbine compressor RPM) (not more than 2%).
2. Check engines response:
  - rotate the throttle twister all the way to the right (clockwise) and operate in this mode for 1 min;
  - remember RPM of the turbine compressor;
  - rotate twister all the way to the left (counterclockwise);
  - rotate throttle twister all the way to the right within 1-2 seconds and measure time from the beginning of rotation to the moment when the RPM of turbine compressor reaches RPM, which is 1-1.5% less than one, observed on the fully opened throttle;
  - engines response should be within 3-6 seconds range.
3. Transition to the generator mode: 1<sup>st</sup> generator -"вкл" (on), using the rotating switch, measure the interphase voltage, 2<sup>nd</sup> generator -"вкл" (on), measure the interphase voltage, set the rotating switch to the "115 В" (115 V) position.
4. Enable and check rectifiers (ВУ) – "вкл" (ON), enabling them one by one and checking current using ampermeter;
5. Check the system adjusting main rotor RPM:
  - set the collective to 3° according to the main rotor pitch angle indicator, when throttle is twisted all the way to the right, oil temperature in the main driveshaft must be not less than 30°C;
  - deflect the N2 trim INCR-DEC switch downward and after main rotor RPM has settled, check the value of main rotor RPM, it should be within 91±2%;
  - deflect the switch upward and make sure that the main rotor RPM is within 96..99%;
  - if the upper limit of the main rotor RPM has not been reached, warm up oil in the main driveshaft to 40-60°C and repeat the check;
  - after checking the main rotor RPM range, by deflecting the N2 trim INCR-DEC switch, set a main rotor RPM of 94..95% and lower the collective all the way down.
5. Check anti-icing system of main rotor, tail rotor, windshields and dust protection devices (if necessary) according to [7.4.6](#)
7. "Обогрев ПВД" (Pitot tube heating) – check (if necessary);
8. SPUU-52- check:
  - enable the circuit breaker on the right circuit breaker console, enable the "СПУУ-52" (SPUU-52) on the left triangular panel;
  - return pedals to the neutral position;

- press the "откл" button (lamp goes on), set the indicator to the middle position;
- by keeping the the "откл" button pressed, set the spring loaded switch to the "t" position, pointer on the indicator deflects to the right mark, then to the "P" position – pointer deflects to the left mark;
- release the button and the switch – lamp button goes off, and pointer on the indicator returns to the middle position;
- press the "откл" button and while keeping it pressed, by rotating the "Контроль" (CHECK) knob, deflect the pointer all the way to the right;
- disable the the "СПУУ-52" (SPUU-52) and release the lamp-button, pointer on the indicator should deflect all the way to the left, while lamp-button continues being on;
- enable the the "СПУУ-52" (SPUU-52), press the lamp-button and while keeping it pressed, by the "Контроль" (CHECK) knob set the pointer to the middle position;
- during flight the zero pointer on the indicator can deflect itself to the left, when ambient temperature increases or air pressure reduces.

### B. Avionics check

Switch on all the flight, navigation, radio communication and electronic equipment required for the flight, and test for proper functioning.

7. Prior to powering up the АГБ-3К (AGB-3K) attitude indicator, cage the device by pressing the "АППЕТИР" (CAGE) button: pressing the "АППЕТИР" (CAGE) button **[LCtrl + LShift + N]** (**[RCtrl + RShift + N]** for right) and switch on **[LAlt + LShift + G]** (**[RAlt + RCtrl + P]** for right) and test the attitude indicator

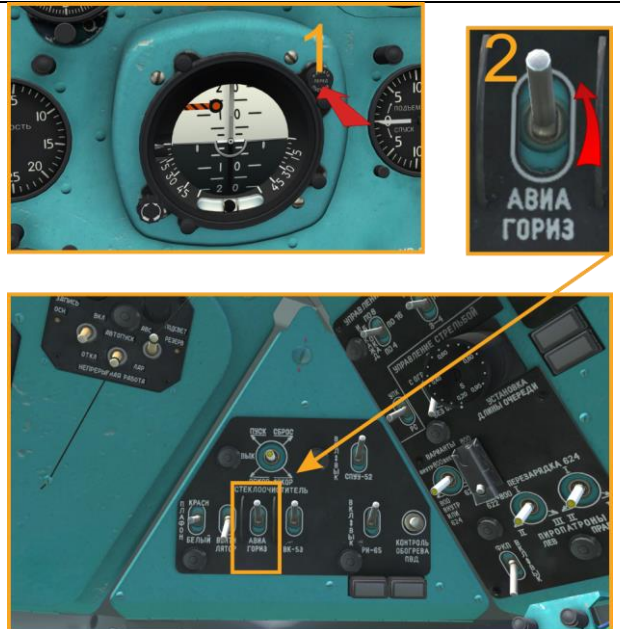

## 8. Switch on:

- the BK-53PШ (VK-53RSh) gyro correction cutout switch  
[LAlt + LShift + F];
- the СПУУ-52 (PITH LIM SYS)  
[LAlt + LShift + T];
- the РИ-65 (INF REP) [not assigned]

 9\*. Switch on the ADF and tune to the desired channel/frequency (detailed instructions [here](#));

## 10. Switch on:

- the "ДИСС-15" (DISS-15) Doppler navigation system [RAlt + RShift + T];
- the right AGB-3K: pressing the "АРРЕТИР" (CAGE) [RCtrl + RShift + N] and switch on [RAlt + RCtrl + P];
- the gyromagnetic compass ГМК-1А (GMK-1A) [RAlt + RShift + U].





11\*. When directional gyro heading arrow settles on the starting ground course, set the ГМК-1А (GMK-1A) gyromagnetic compass to ГПК (directional gyro) mode

[RCtrl + RShift + O]



12\*. Test the autopilot by pressing:

- yaw channel – the "НАПРАВЛЕНИЕ" (YAW) [LCtrl + A],
- roll-pitch channel – "КРЕН-ТАНГАЖ" (ROLL- PITCH) – [LWin + A],
- altitude channel – "ВЫСОТА" (ALTITUDE) [LAlt + A]

button-lamps on the autopilot control panel.



13\*. With feet off the pedals, press the "3К" momentary switch on the PU-26 control panel for a short time to the left or right [not assigned]. The YAW channel scale on the autopilot control panel should rotate in response to the manual heading change input.

Another translate var

13\*. Deflect the spring-loaded "3К" switch to the left for or to the right momentary. Due to that the "НАПРАВЛЕНИЕ" (DIRECTION) scale should begin rotating to the corresponding direction.





14. Enable the MIGALKA (FLASH) system

**[RCtrl + -]**.

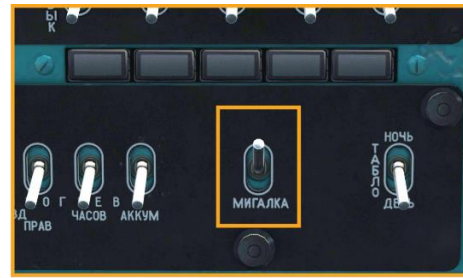

For night flights:

- enable (if no before) the navigation lights **[RCtrl + 1]** (dimmed) or **[RCtrl + 2]** (bright), MSL-3 flasher **[RCtrl + 6]** and rotor tip lights. If necessary, turn on the formation lights **[RCtrl + 3..4]**;
- enable the taxi light **[RCtrl + L]** and landing lights **[LShift + L]** (left), **[RShift - L]** (right); lights can be controlled by the **[LShift + 9;-;0]** (left), **[RShift + 9;-;0]** (right), more in details in the chapter [7.8.1](#).

## 9.6. Engine shutdown

*In preparation for idle power setting:*

1. Switch off the PZU particle separators **[LCtrl + D]** / **[RCtrl + D]**

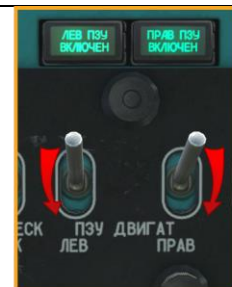

2. Switch off all electrical power consumers apart from powerplant monitoring and control systems (left and right side):



3. Switch OFF the rectifiers **[LCtrl + LShift + 4..6]**, set the "ПО-500А" (Inverter 1) switch to "РУЧНОЕ" (MANUAL (up)) **[LAlt + LShift + 4]**, switch OFF the AC generators **[LAlt + LShift + 6]**

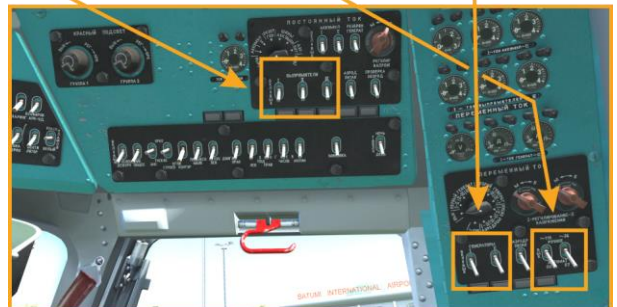

***engines idle power and stop:***

4. Turn the throttle full left **[PgDn]** and perform the following steps:



5. After allowing the engines a 2 minute cool down period in idle power, close (pull aft) the "ОСТАНОВ. ДВИГ. ЛЕВ. ПРАВ." (ENGINE STOP LFT/RGT) fuel shutoff levers **[RCtrl + PgUp]** (left) / **[RCtrl + PgDn]** (right)

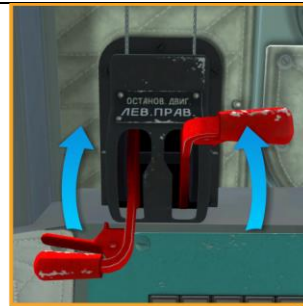

6. After Nr <15% – engage the rotor brake

**[RCtrl + R]**

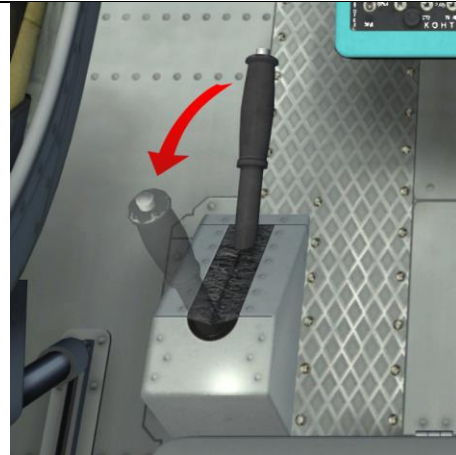

7. With engines fully stopped, switch off the fuel fire (shutoff) valves **[LAlt + 5..6]** (for cover up)

then **[RAlt + 5..6]**





8. Switch off the fuel boost **[RShift + 1]** and transfer pumps **[RShift + 2..3]**

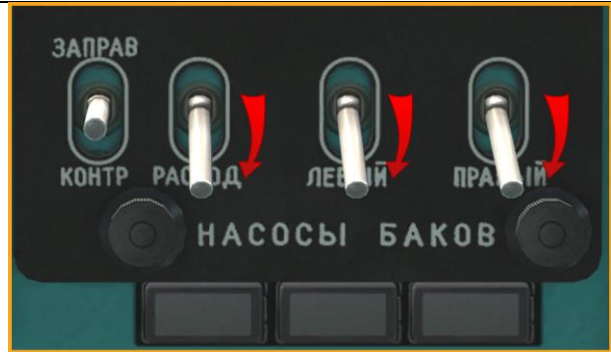

9. Switch off all of the circuit breakers and set all other control switches to OFF positions, apart from the reserve hydraulic system

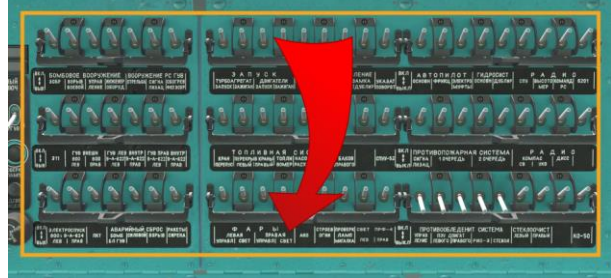

10. Switch OFF the batteries **[LCtrl + LShift + 1]**





11\*. Set the "САРПП-12Д1М "РУЧН – АВТОМ" (FLIGHT RECORDER) switch to the "АВТОМ" (AUTO) position (down)

**[LAlt + LCtrl + LShift + 6]**



## 9.7. Preparing for taxi and taxiing

A. Prior to taxi, perform a taxi check:

- external power cables are disconnected: **[N]** (Radio Menu), **[F8]**, **[F2]**, **[F2]**;
- fuel pumps are on (check switch positions and indicator lights);
- APU is shut down;
- all circuit breakers are switched ON.

B. Check the taxiway is clear of obstructions and proceed to:

- set throttle full right;
- switch ON PZU particle separators;
- check main rotor RPM to be within  $95 \pm 2\%$ ;
- request clearance to taxi;
- release the wheel brakes **[W]**.

Increase collective to set  $1-2^\circ$  of collective pitch and slightly push forward on the cyclic to begin forward movement.

C. Maintain weight on wheels during taxi.

If the ground surface prevents safe taxiing, perform hover taxi using low speed/low altitude flight.

D. Taxi speed should not exceed 15 - 20 km/h. Perform taxi turns using smooth pedal input and small moving the Cyclic to side of turn. Avoid completely unloading weight off the nose wheel shock strut.

E. Wind speed during taxi must not exceed 15 m/s. In crosswind conditions, the helicopter tends to turn into the wind. Correct any uncommanded turning tendency with slight opposite pedal and any uncommanded roll with slight opposite cyclic.

F. Upon reaching the takeoff position, check the flight and navigation indicators, ensure the attitude indicator is powered up (no warning flag present), the heading indicator shows correct bearing to the selected ADF beacon, and the compass set is slaved and indicating correct takeoff heading.

Start the flight timer on the AChS-1 cockpit clock by pressing the left red knob **[RALT + RCTRL + RSHIFT + C]**.

## **9.8. HOVER**

A. The following maximum hover altitude limitations apply depending on helicopter gross weight (GW):

- GW ≤ 11,100 kg: 10 m
- GW > 11,100 kg: 5 m

Hover altitudes greater than above limitations are allowed when carrying external sling loads or if dictated by tactical requirements.

B. Yaw rate in hover must not exceed 12°/sec.

C. To perform a hover:

- position the helicopter into the wind if possible
- check throttle set full right
- smoothly increase collective to set collective pitch to 3°
- check main rotor RPM to be 95%. If necessary adjust main rotor RPM using the N<sub>2</sub> TRIM INCR-DECR switch on the collective control handle
- turn off the autopilot (all channel) **[LWin + LShift + A]** and then turn on the autopilot "КРЕН-ТАНГАЖ" (ROLL-PITCH) **[LWin + A]** channel by pressing the corresponding button-lamps and checking for green light illumination
- continue to smoothly increase collective to lift the helicopter off the ground and climb until reaching desired hover altitude

D. Increase of collective control during liftoff must be smooth and gradual, allowing no less than 5 seconds for the engines to attain Takeoff power, ensuring main rotor RPM is maintained within normal limits of 92 - 94%.

E. During liftoff, the helicopter tends to drift forward and left.

F. The cyclic control stick deflection in hover is approximately:

- 1/4 stick travel aft when helicopter CG is at normal to aft limit position;
- 1/2 stick travel aft when helicopter CG at the forward limit position
- 1/4 stick travel right regardless of CG position

## **9.9. Shifts and hops at low altitude**

A. Shifts and hops at low altitude may be performed for training purposes, special purpose operations, and in cases where the ground surface conditions do not allow for safe ground taxi.

B. Lateral and reverse hover flight speed may not exceed 10 km/h. Use the ground for visual reference and ensure that the flight path is clear of obstacles.

C. Forward hover flight altitude may not exceed 10 m and speed not exceed 20 km/h. Use the ground for visual reference and the stationary flight indicator of the Doppler system for precise flight control.

With wind speeds of up to 10 m/s, shifts and hops at low altitude can be performed into the wind or at 90° to the wind. With wind speeds greater than 10 m/s, hover taxi should only be performed into the wind.

D. Perform low level flight over uneven terrain (gullies, ditches, drop-offs, etc.) at altitudes of no less than 20 m and speeds no less than 60 km/h.

### **9.10. Takeoff**

Takeoff is performed using one of the following procedures:

- vertical takeoff with acceleration in ground effect
- vertical takeoff with acceleration out of ground effect
- running takeoff
- running nose wheel takeoff

The minimum dimensions of the airfield required for a takeoff or landing at altitudes of up to 1500 m are as follows:

- 50 x 50 m for a vertical takeoff/landing free of obstacles
- 50 x 120 m for a vertical takeoff/landing with an obstacle height of 15 m at the airfield outer edge
- 50 x 160 m for a running takeoff/landing free of obstacles
- 50 x 200 m for a running takeoff/landing with an obstacle height of 15 m at the airfield outer edge

#### ***Vertical takeoff with acceleration in ground effect***

A vertical takeoff with acceleration in ground effect may be performed when the helicopter hovers at an altitude of no less than 3 m with the engines set to Takeoff power.

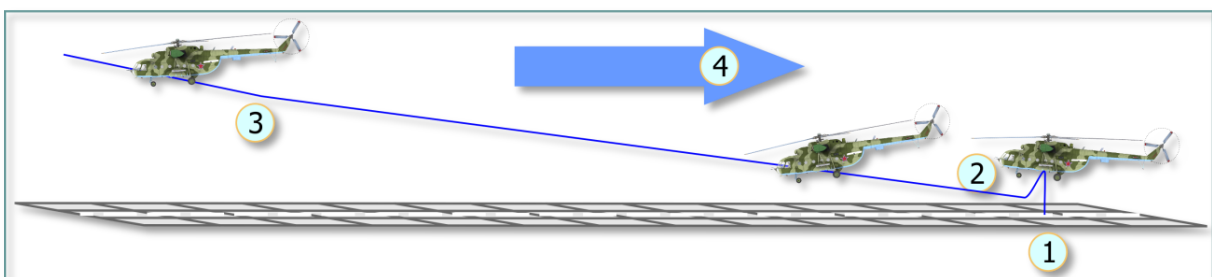

**Fig. 9.1. Vertical takeoff with acceleration in ground effect**

Position the helicopter into the wind (4) and perform a hover safety check to ensure the helicopter is ready for takeoff (1). Confirm normal indicator readings and a sufficient hover altitude for a vertical takeoff. Reduce altitude to 0.5-1 m (2) and begin the takeoff by smoothly pushing the cyclic forward while simultaneously

advancing power as required up to Takeoff setting to avoid main rotor RPM drooping below 92%. Accelerate in ground effect in a shallow climb to reach 60-70 kph at an altitude of 20-30 m (3). Transition to a climbout attitude while accelerating to 120 kph.

### ***Vertical takeoff with acceleration out of ground effect***

A vertical takeoff with acceleration out of ground effect must be performed when the takeoff area is confined and surrounded with obstacles, and the helicopter's takeoff weight allows for a hover out of ground effect.

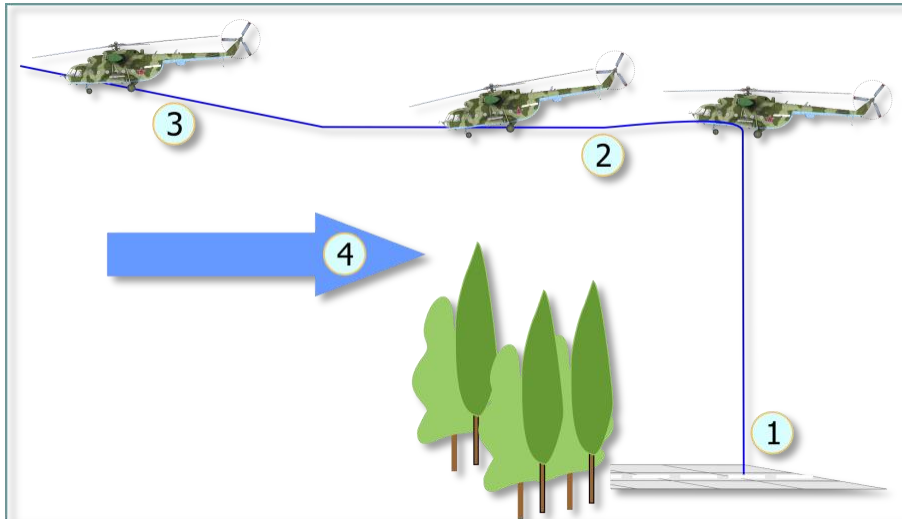
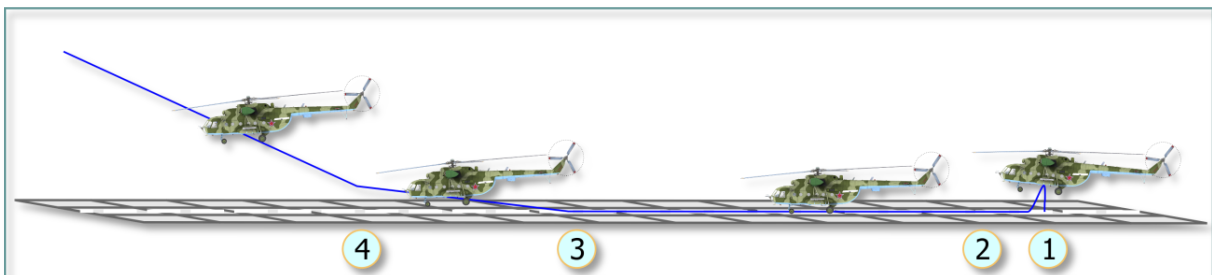

**Fig. 9.2. Vertical takeoff with acceleration out of ground effect**

Position the helicopter into the wind (4). Perform a vertical takeoff while minimizing drift (1) to an altitude of at least 10 m above obstacle height. In the vertical climb, monitor the main rotor RPM to ensure it does not droop below 92%. Having attained a hover altitude sufficient for a safe transition to forward flight above obstacle height, smoothly push the cyclic forward to accelerate up to 20-50 kph (2). Transition to a climbout attitude while accelerating up to 120 kph (3).

### ***Running takeoff***

A running takeoff may be performed if the helicopter hovers at an altitude of no less than 1 m with the engines set to Takeoff power. For a running takeoff, only the ROLL-PITCH channel of the autopilot should be engaged.



**Fig. 9.3. Running takeoff**

Perform a hover check then land the helicopter (1). Reduce collective until the helicopter rests on the ground with weight on wheels.

Push the cyclic forward and simultaneously increase collective to establish forward acceleration up to 20-50 kph (2). Increase collective further to attain Takeoff power and lift the helicopter off the ground (3).

In the takeoff run, the helicopter tends to lift off the main wheels first, followed by the nose wheel. Compensate for this tendency with slight pull aft of the cyclic at the moment of liftoff.

After liftoff, continue to accelerate up to 120 kph in a shallow climb, followed by a transition to a climbout attitude (4).

The takeoff run requires 250 - 300 m. If the takeoff area is limited or blocked by obstacles, the transition to climbout can be made at 50 - 60 kph.

### ***Running nose wheel takeoff***

A running nose wheel takeoff may be performed to increase takeoff performance with a high takeoff weight or to reduce the distance of the takeoff run on airfields that provide for a safe ground run.

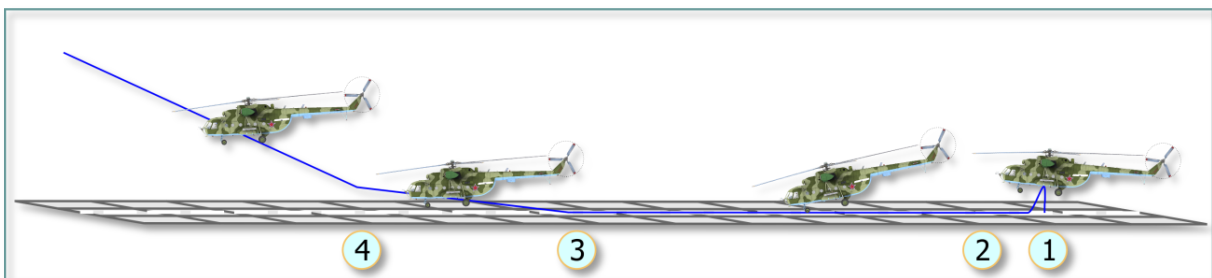

**Fig. 9.4. Running nose gear takeoff**

Perform a hover safety check then land the helicopter (1).

Disable the autopilot by pressing the AUTOPILOT OFF button on the cyclic control stick. Reduce collective pitch to minimum by lowering the collective control handle to the lower stop (full down). Apply the wheel brakes. Push the cyclic control stick to the forward limit and proceed to turn ON the autopilot ROLL-PITCH channel by pressing the corresponding button-lamp on the autopilot control panel and checking for green light illumination. Pull the cyclic control stick to the aft limit and release the stick force by pressing the TRIM button on cyclic control stick. The forward and aft deflection limits of the cyclic are determined by the absence of thumping noise as the main rotor blades strike against the flapping hinges of the rotor assembly.

Release the wheel brakes. Smoothly increase collective until the main landing gear begins to lift off the ground. Maintain the nose gear on the ground. Smoothly (3 - 5 sec) push the cyclic forward 1/2 to 2/3 stick travel to begin the ground run and establish a nose-down pitch attitude of  $-8$  to  $-9^\circ$  below standing pitch (2). Control the pitch angle during the ground run by maintaining the blade tips of the rotor disc on the horizon line. Smoothly increase engine power to Takeoff setting in the ground run.



At approximately 40 kph the helicopter exhibits a tendency to pitch up and sink onto the main gear, followed by a reversal and an energetic pitch down. These tendencies must be countered with corresponding forward and aft cyclic control adjustments.

Lift off 1 - 2 seconds after the pitch down with a smooth cyclic pull aft as ground speed reaches 60 - 65 kph (3). Continue to accelerate to 70 - 80 kph up to an altitude of 10 m. Proceed with climbout at a speed of 120 kph (4).

With a maximum takeoff weight of 1300 kg, a ground run of 150 m is required for a paved runway or 340 m for a field airstrip. If the helicopter's CG is close to the aft limit, the ground run distance increases by a factor of 1.5.

After leveling off at the desired altitude in stabilized in level flight, switch OFF the autopilot by pressing the AUTOPILOT OFF button on the cyclic control stick, stabilize the controls and switch ON the autopilot ROLL-PITCH and YAW channels by pressing the corresponding button-lamps on the autopilot control panel and checking for green light illumination.

### **9.11. Climb to altitude**

A. The optimal climb speed is 120 kph in altitudes up to 2000 m; 110 kph in altitudes of 2000 - 4000 m; and 100 kph above 4000 m. Climbs are normally performed in maximum continuous engine power. If required, the climb may be performed in Takeoff power (limited to 6 minutes) as well as power settings below maximum continuous.

After completing the takeoff, establish the desired climb rate and switch OFF the PZU particle separators.

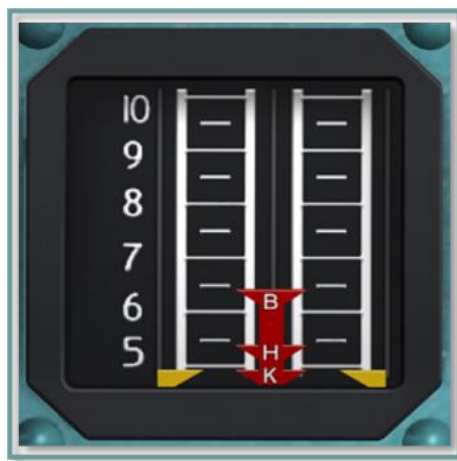

**Fig. 9.5. Engine pressure ratio (EPR) indicator**

B. Current engine power setting is monitored on the engine pressure ratio (EPR) indicator up to an altitude of 2500 m and is determined by the position of the side indices with respect to the "H" and "K" markers:

- Takeoff power: side indices above "H"
- Maximum continuous power: side indices above "K" up to "H"
- Cruise power: side indices aligned with or below "K"

C. At altitudes greater than 2500 m, engine power setting is determined based on corresponding performance charts.

D. In a climb at maximum continuous power with a constant collective pitch angle, the main rotor RPM is automatically maintained at  $95\pm 2\%$  up to a limited altitude. Further climb will result in the main rotor RPM drooping as engine power output is reduced due to compressor RPM limits imposed by the engine governor system. Maintain main rotor RPM above 92% by gradually reducing collective pitch as main rotor RPM begins to droop. The maximum continuous power limitations begin to affect main rotor RPM at 1000 - 1500 m.

In a climb at cruise power with a constant collective pitch angle, the main rotor RPM is automatically maintained constant up to an altitude of 2000 - 2500 m.

In a climb at takeoff power with constant collective pitch angle, the main rotor RPM is **not** maintained automatically. Maintain main rotor RPM in the 92-94% range by gradually reducing collective pitch as altitude increases.

### **9.12. Level flight**

The recommended airspeed for flying an airfield pattern is 160 kph.

Roll angles are limited to  $30^\circ$  at normal takeoff weight and  $20^\circ$  at maximum takeoff weight.

### **9.13. Transitional maneuvers**

A. To transition from a vertical climb to a hover after reaching the desired altitude, stop the climb by smoothly reducing collective and maintain altitude with slight collective adjustments.

B. To transition from a hover to a vertical descent, reduce collective and ensure the descent rate does not exceed 0.2 m/s near the ground prior to touchdown.

C. To transition from a hover to level flight, push the cyclic forward to establish an accelerating attitude. Simultaneously adjust (slightly increase) collective to maintain altitude and counter any lateral drift and yaw with opposite cyclic and pedal input. When approaching the desired airspeed, pull the cyclic aft to stabilize in a level flight attitude and maintain airspeed.

D. To transition from level flight to a hover while maintaining altitude, smoothly reduce collective and pull the cyclic aft to reduce airspeed. Upon reaching airspeed of 50 - 60 kph, the helicopter exhibits a tendency to descend. Counter this tendency by increasing collective. At airspeeds below 50 kph, the helicopter develops vibrations, which disappear as airspeed is reduced further. At airspeeds below 40 - 20 kph, the helicopter exhibits a tendency to yaw left. Timely application of cyclic and right pedal input is required to avoid uncommanded roll and left yaw in the transition to hover.

E. To transition from level flight to a power-on glide, reduce collective and apply cyclic to establish a desired glide speed attitude.

F. To transition from a power-on glide to level flight, apply collective to set engine power as required for level flight and apply cyclic to establish a desired airspeed.

G. In transitional maneuvering, the main rotor RPM is automatically maintained at  $95 \pm 2\%$  only within a limited rate of collective application:

- when increasing collective, no less than 5 seconds from 1 - 3° collective pitch up to the pitch angle establishing takeoff power.
- when reducing collective, no more than 1°/sec from any starting collective pitch angle

Collective input rates above these limits can lead to main rotor RPM drooping below the minimum allowable limit (88%) when increasing collective or overspeed the main rotor above the maximum allowable limit (103%) when reducing collective.

If main rotor RPM runs outside  $95 \pm 2\%$ , adjust collective to return RPM to the normal range.

Large deflections of the cyclic can lead to main rotor RPM drooping in accelerations and increasing RPM in decelerations. The range of main rotor RPM divergence is proportional to the rate of cyclic deflection.

When performing transitional maneuvers, unload the forces on the controls with short presses of the TRIM button on the cyclic control handle as the flight controls are adjusted.

### **9.14. Descent**

Depending on altitude, power-on descent may be performed either vertically or on a glideslope. Autorotation may only be performed on a glideslope descent.

#### ***Power-on vertical descent***

A power-on vertical descent from an altitude of 10 m down to the ground is permissible in all conditions. From an altitude of 110 m down to 10 m, a vertical descent is only permissible when a glideslope approach cannot be performed due to obstacles or out of tactical considerations. Descent from the helicopter's service ceiling down to 110 m must be performed on a glideslope and within airspeed limitations.

In a vertical descent from an altitude of 110 m down to 10 m, the descent rate may not exceed 3 m/s. If the descent rate increases beyond 3 m/s, smoothly increase collective to arrest the descent rate. If engine power is insufficient to arrest the descent and maintain main rotor RPM within limits, transition out of the vertical descent to a glideslope descent or forward flight to gain airspeed.

From an altitude of 10 m down to the ground, continually reduce the rate of descent so it does not exceed 0.2 m/s at touchdown.

#### ***Power-on gliding descent***

In a power-on glideslope descent, maintain main rotor RPM within  $95 \pm 2\%$  with collective input as required. Gradual reduction of collective pitch down to the

minimum setting is permissible to maintain a desired descent rate as altitude decreases as long as main rotor RPM is maintained within limits.

The recommended glide speed at altitudes below 2000 m is 120 - 180 kph. The rate of descent at this speed should be 3 - 5 m/s.

### **9.15. Autorotation descent**

A. An autorotation descent is used in case of dual engine failure in flight. To perform an autorotation landing:

- establish a desired descent airspeed prior to initiating the descent
- reduce collective down to the lower stop (full down) and check the main rotor RPM to be within normal limits ( $95\pm 2\%$ )
- counter the any tendency to yaw right and pitch down with opposite pedal and cyclic
- set throttle to full left
- upon transitioning to an autorotation descent, adjust collective as required to maintain main rotor RPM within limits

B. Maintain the following airspeeds in a power-on autorotation descent:

- altitude 2000 m and greater: 100 - 120 kph
- altitude below 2000 m: 120 - 190 kph

The optimum gliding speed for altitudes below 2000 m is 180-190 kph.

C. Maintain a descent rate of 10 - 12 m/s. The minimum rate of descent of 10 m/s corresponds with a gliding speed of 120 kph.

D. Avoid roll angles of greater than  $20^\circ$  during autorotation descents.

E. To recover from a power-on autorotation descent:

- smoothly set throttle to full right while monitoring the engine and main rotor RPM
- at altitudes above 1500 m, counter main rotor overspeeding beyond maximum limits by increasing collective to set a collective pitch angle of  $3 - 4^\circ$
- at altitudes below 1500 m, increase collective pitch only after setting the throttle to full right. Avoid drooping the main rotor RPM below 92% by raising collective gradually

F. Maintain 100 - 120 kph in a power-off autorotation descent

### **9.16. Landing**

Landing is performed using one of the following procedures:

- vertical landing from a hover in ground effect
- vertical landing from a hover out of ground effect
- power-on running landing
- single engine landing
- power-off autorotation landing (only in emergency situations)

When performing any landing with forward airspeed, including autorotation landing, disengage the autopilot YAW and ALTITUDE channels.

### ***Vertical landing from a hover in ground effect***

Perform a glideslope approach at 120 kph. At an altitude of 100 m, smoothly pull the cyclic aft to begin reducing forward airspeed to attain 60 – 50 kph at an altitude of 60 – 50 m.

At an altitude of 5 - 8 m, smoothly pull the cyclic further aft and increase collective as required to establish a hover at a altitude of 2 – 3 m.

The minimum glideslope approach length:

- with GW  $\leq$  11,100 kg is 1000 -1200 m at altitude of 100 m and airspeed 100–120 kph
- with GW  $>$  11,100 kg is 1400 -1500 m at altitude of 100 m and airspeed 100–120 kph

While performing the deceleration and transitioning to a hover, release the forces on the controls with frequent presses of the TRIM button on the cyclic control stick.

Upon stabilizing in a hover, smoothly decrease collective to perform a vertical descent while gradually reducing vertical speed such that it does not exceed 0.2 m/s at touchdown.

Avoid lateral drifting while in the vertical descent. Reduce collective to minimum only when certain that the helicopter is firmly on the ground with weight on wheels.

In a crosswind landing, apply cyclic opposite of the wind direction to maintain position over the landing point until the helicopter is firmly on the ground with weight on wheels.

### ***Vertical landing from a hover out of ground effect***

Perform a vertical landing from a hover out of ground effect only when obstacles make it impossible to perform a landing from a hover in ground effect.

The procedure for a vertical landing from a hover out of ground effect is identical to a vertical landing from a hover in ground effect.

Begin the deceleration at an altitude of 50 m above obstacle height such that a hover position over the landing point is attained at an altitude of no less than 5 m above obstacle height.

### ***Power-on running landing***

A power-on running landing may be performed in cases where engine power is insufficient to ensure a hover and vertical landing (such as high gross weight, high altitude, high temperatures).



The landing can be performed on a prepared runway or a an unprepared area known to be safe for such an approach (must be sufficiently level and large) provided a clear approach path is available.

Execute the final approach on a glideslope with an airspeed of 120 kph.

Maintain the glideslope such that airspeed is maintained 20 kph faster than current altitude, i.e. 100 kph at 80 m down to an altitude of 40 m.

Perform the remainder of the descent with a continual reduction of airspeed and rate of descent such that at 0.5 - 1 m above the ground, the airspeed is reduced to 50 - 40 kph and the rate of descent is reduced to 0.1 - 0.2 m/s.

Perform a smooth touchdown on the main gear and reduce collective to minimum. Allow the nose gear to touch down. Set throttle to full left and apply the wheel brakes to brake the helicopter. Anticipate a landing run of 20 - 30 m. The total field distance for safe operations should be no less than 100 m.

If the airfield dimensions do not allow for a landing run of 20 - 30 m, but it is necessary to perform a running landing, execute a running landing with a short landing run.

Begin a smooth reduction of forward airspeed and rate of descent at an altitude of 40 - 50 m above the field by increasing collective and pitching the helicopter up with aft cyclic while maintaining the main rotor RPM within allowed limits. Perform a landing deceleration maneuver so as to attain near takeoff engine power at an altitude of 5 - 10 m with a ground speed of 20 - 40 kph. At an altitude of 5 - 10 m, push the cyclic forward to bring the helicopter to a landing attitude while avoiding a tail boom strike against the ground, but ensuring continued reduction of ground speed down to 10 - 15 kph for touchdown. At an altitude of 5 - 10 m, raise collective at a rate of 2 - 4°/sec to reduce the rate of descent such that it is no greater than 0.2°/sec at touchdown. Upon touchdown, push the cyclic forward 1/3 - 1/4 stick travel, reduce collective down to minimum, set throttle to full left, and apply the wheel brakes to brake the helicopter.

### ***Single engine landing***

Perform a single engine landing onto a flat landing area that provides for a clear approach or onto a prepared runway. The gross weight of the helicopter for a single engine landing may not exceed 10,000 kg.

Perform a single engine landing into the wind if possible or with a crosswind not exceeding 5 m/s.

At an altitude of 300 m, before starting the APU, switch OFF the engine anti-icing system and PZU particle separators if these were previously switched on. Start the APU. Confirm successful APU start and illumination of the OIL PRESS NORMAL (ДАВЛ. МАСЛА НОРМА), NORMAL SPEED (ОБОРОТЫ НОРМА) lights.

Execute a single engine landing so that the helicopter touches down at 10 - 20 kph or 50 kph (as decided by the pilot in command) as follows:

- control collective pitch to maintain main rotor RPM within 95±2%

- ensure the operating engine attains emergency power setting
- maintain an airspeed of 20 kph higher than current altitude (in meters) during the approach
- establish a landing attitude at an altitude of 5- 7 m
- from an altitude of 3 - 5 m, reduce the rate of descent by increasing collective. Simultaneously apply smooth right pedal to counter torque-induced yaw from increased collective pitch and use cyclic control to maintain the landing attitude. When increasing collective, ensure that main rotor RPM does not fall under 88%
- upon touchdown immediately decrease collective smoothly and push the cyclic forward 1/3 - 1/4 stick travel to prevent a tail boom strike
- apply wheel brakes after nose gear touchdown to brake the helicopter

Using this procedure the helicopter touches down at a speed of 10 - 20 kph and the landing run is 5 - 20 m. To touch down at a speed of 50 kph, perform the approach such that the airspeed is maintained 20 kph higher than current altitude down to an altitude of 40 m, then maintain 60 km/h down to 5 - 7 m. Perform the touchdown as described above, which results in a landing run of 80 - 100 m due to the higher landing speed.

### **9.17. Search and Rescue (SAR) operations**

A. Prior to departure for a SAR mission:

- turn on the VHF ADF (РАДИОКОМПАС УКВ) circuit breaker on the right circuit breaker panel of the overhead console.
- on the VHF ADF (АРК – УД) control panel, set the mode selector switch to NS (ШП), the frequency selector switch to VHF (УКВ), and the CHANNELS (КАНАЛЫ) selector switch to 4.
- on the intercom control box, set the selector switch to PK2 and the INT - RADIO (СПУ–РАДИО) selector switch to RADIO (РАДИО)
- fly the helicopter to enter the search area bearing in mind that the VHF ADF (АРК – УД) detection and homing ranges increase with altitude (at an altitude of 500 m the coverage is no less than 25 km)
- with the ADF operating in standby reception mode, positive reception of a beacon signal will be indicated by the corresponding indication light.

B. After detection and identification of the beacon signal, determine its location as follows:

- set the mode selector switch to a position corresponding to the indication light: narrow band NB (УП) or broadband BB (ШП) if the NB light is on, set the mode selector switch to NB
- test the pointer arrow by pressing the ANT L (АHT. Л) or R (АHT. П) buttons to manually turn the arrow and make sure that it returns to the signal bearing when the buttons are released
- turn the helicopter so that the pointer arrow points to "0" and continue to fly the helicopter to maintain the pointer arrow in this position. At long ranges to the beacon, begin homing in narrow band NB (УП) mode. As signal strength increases (indicated by increasing volume in the headset),

select the broadband BB (ШП) mode. The VHF ADF operation is more reliable in broadband mode.

### **9.18. *Flight (hover) over featureless terrain using the Doppler Navigation System***

**A.** The stationary flight indicator provides visual indication of the ground speed in the following speed ranges: 0 - 50 kph in forward flight, 0 -25 kph in reverse flight, 0 - 25 kph in lateral flight.

**B.** The forward and lateral speeds are indicated by corresponding moving indexes against a numerical scale (up and down for forward and reverse flight, left and right for lateral flight). Vertical velocity is indicated by a moving triangular index along the left side of the indicator.

Before takeoff, turn on the Doppler system by setting the DOPPLER (ДИСС) circuit breaker on the overhead console and the DOPPLER (ДИСС) switch on the right switch panel of the overhead console to ON (ВКЛ).

**C.** When hovering, observe the indicators of the Doppler system. Apply cyclic control opposite of the movement of the line indicators to maintain a hover position by keeping the indicators inside the center ring position. Maintain the vertical velocity indicator at "0" to maintain altitude.

In limited visibility conditions when the natural horizon cannot be seen, control the helicopter's attitude using the Attitude Indicator and other flight instruments. Control hover altitude using the radar altimeter. The radar altimeter provides accurate altitude indication up to 1000 m above ground level (AGL). If airspeed reaches 50 kph, the stationary flight indicator will turn off and the OFF (ВЫКЛ.) light will illuminate.

### **9.19. *Night operations in visual meteorological conditions (VMC)***

**A.** The start, ground test, and shutdown procedures for nighttime operations are identical to daytime operations except the following: additionally turn on the LAND LIGHTS (ФАРЫ), NAV LTS (АНО), FORM LIGHTS (СТРОЕВ. ОГНИ) and CHK BLINKER (ПРОВЕРК. ЛАМП-МИГАЛКА) circuit breakers on the overhead console and set the DOME LT RED - WHITE (ПЛАФОН КРАСНЫЙ – БЕЛЫЙ) selector switches to WHITE (БЕЛЫЙ) on the left and right switch panels of the overhead console. Turn down the red lighting rheostats on the left and right side panels of the overhead console and the flight compartment doorway. Turn on ФР-100 taxi light.

**B.** After starting the engines and disconnecting the external electrical power source, switch off the white dome lights, set the DAY - NIGHT (ДЕНЬ – НОЧЬ) selector switch to NIGHT (НОЧЬ), and turn on the BLINKER (МИГАЛКА), ANTI-COLL LIGHT (ПРОБЛЕЕК) and BLADE TIP (КОНТУР. ОГНИ) switches. Set the navigation and formation lights switches to BRIGHT (ЯРКО) or DIM (ТУСКЛО) as desired.

Taxi with the ФР-100 taxi light on. Use the ФПП-7 landing/search lights only when required for improved forward visibility or taxi turns. Limit operation of the ФПП-7 landing/search lights to 5 minutes followed by a 5 minute cooling period.

**C.** Take off with both the ФР-100 taxi and ФПП-7 landing/search lights turned on. Adjust the direction of the light beams in a hover at an altitude of 3 - 5 m by operating the corresponding switches on the collective control handle.

**D.** Accelerate and climb out to an altitude of 50 m more gradually than in daytime operations. At an altitude of 30 - 50 m, transition to instrument flight and turn off the taxi and landing/search lights.

**E.** For night time flying, refer primarily to the flight instruments with occasional checking of the outside airspace.

**F.** Perform approach and landing maneuvers as during daytime operations. At an altitude of 50 – 70 m, turn on the ФПП-7 landing/search lights. If the landing/search lights make visual perception of the ground more difficult, turn the lights off and use other light sources for ground reference, such as ground-based light projectors if available. Use the radar altimeter to control altitude with visual ground checks using available light source references.

After landing, taxi with the ФР-100 taxi light turned on.

## ***9.20. Day or night operations in instrument meteorological conditions (IMC)***

**A.** Prior to embarking on any flight in IMC, carefully examine the weather conditions in the area of operations, paying special attention to possible icing conditions, wind speeds and directions. Flight inside clouds is permissible up to an altitude of 3500 m.

**B.** Before taxiing out, check that all circuit breakers and switches required for flight are turned on and set correctly. Ensure normal operation of the autopilot control channels, attitude indicators, turn indicators, ADFs, compass system, radar altimeter, windshield wipers, and the Doppler system speed and drift indication. Check that the clock is running and set for the correct time. The pressure on the barometric altimeter should correspond to the actual airfield pressure when the altimeter is set to 0 altitude. Check that the compass system is turned on and operating normally, the setting of the latitude correction, selection of magnetic compass (МК) mode, and the Doppler system is operating normally as indicated by the FUNC (РАБОТА) light on the control panel.

**C.** For ambient temperatures of +5°C or below, turn on the pitot tube heaters before taxiing out of the parking area and turn them off after taxiing to the parking area.

Before taxiing out of the parking area in ambient temperatures of +5°C or below, turn on the engine anti-ice systems to prevent icing in the air intakes and ingestion of ice into the engines by setting the ANTI-ICING SYSTEM. ENG DUST PR-LEFT and ANTI-ICING SYSTEM. ENG DUST PR-RIGHT (ОБОГРЕВ. ДВИГ. ПЗУ ЛЕВ. (ПРАВ)) switches to ON (ВКЛ.).

**D.** Set the chart angle for the selected route on the coordinate indicator of the Doppler system, set the range and angle error to 0, and turn off the control panel using the OFF (ВЫКЛ.) button.

**E.** After taxiing to the takeoff position, slave the compass system, set heading pointer of the heading indicator to the takeoff magnetic heading.

**F.** Request permission for takeoff from the controller. Upon receiving clearance, proceed with takeoff. Maintain visual contact with the ground in hover.

**G.** After takeoff and before entering the cloud cover, establish a climbing profile at an airspeed of 150 kph and a climb rate of 3 - 4 m/s. Transition to complete instrument flight 25 - 30 m below cloud cover.

When flying in clouds, the following flight profiles are recommended:

- climb speed of 150 kph at climb rate of 3 - 4 m/s
- descent speed of 120 - 200 kph at rate of descent of 3 - 4 m/s
- horizontal flight speed of 160 - 180 kph for a standard approach

Prolonged route flying at altitudes of up to 1000 m at the following airspeed:

- 220 kph at normal takeoff weight
- 200 kph at maximum takeoff weight

### **9.21. *Wide rectangle pattern***

The wide rectangle pattern is a convenient landing pattern when the approach to the locator middle marker (LMM) is made within 60° of the magnetic landing course.

Perform an IMC approach and landing by referencing the LMM, which is positioned at a distance of 1300 m from the landing point. The recommended pattern altitude is 300 m, airspeed is 160 kph, roll angle in turns is 10°.

If flying the pattern after takeoff, establish a climbing profile for an airspeed of 150 kph and a climb rate of 3 - 4 m/s.

Perform the first turn to the crosswind leg at an altitude of no less than 150 m at distance of 3500 m from the reference starting line (runway takeoff position) or when the calculated flight time for the initial leg has expired (1 min 32 sec in calm weather). Upon reaching an altitude of 300 m, establish level flight at 160 kph. In a missed approach or practice approach without landing, perform the first turn to the crosswind leg 2 minutes after passing over the LMM.

Perform the second turn to the downwind leg when the LMM relative bearing (RB (bearing from current heading to marker) equals 240° ± drift angle (DA) (120° ± DA for a right-hand pattern) or upon reaching the required magnetic radio bearing (MRB, bearing to marker from due North and indicated on the heading indicator compass card by the bearing pointer) 3 min 27 sec after takeoff time.

Perform the third turn to the base leg when RB = 240° ± DA (120° ± DA for a right-hand pattern) or upon reaching the required MRB.

On the base leg, descent at a rate of 2 - 3 m/s and establish an airspeed of 155 kph. Descend to an altitude of 200 m.



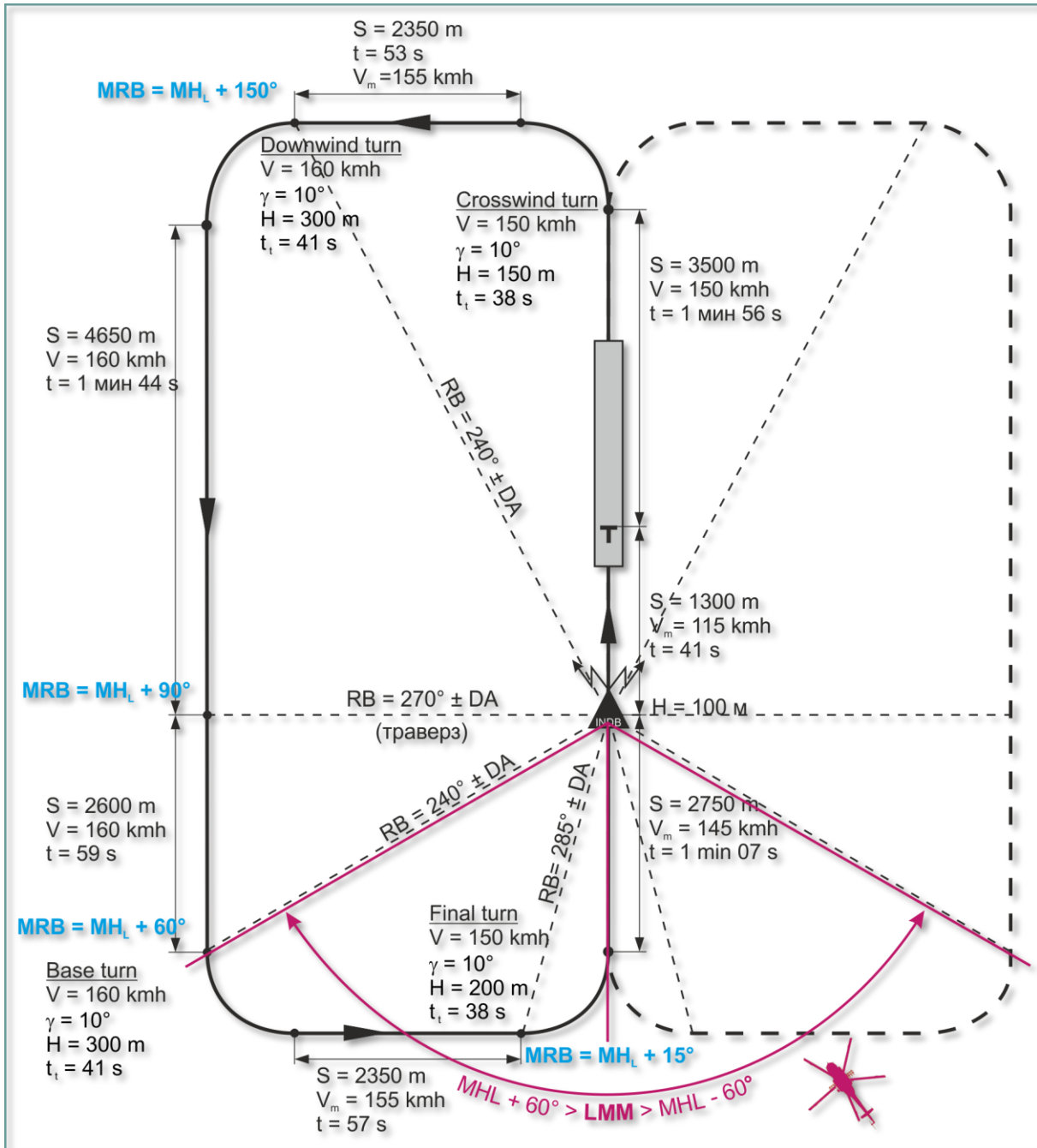

**Fig. 9.6. Wide rectangle pattern diagram:**

S - Distance  
 V - Airspeed  
 H - Altitude  
 $\gamma$  - Bank angle  
 t - Time  
 $t_i$  - Turn time

RB - NDB radio bearing  
 DA - Drift angle  
 MRB - Magnetic radio bearing to beacon  
 $MH_L$  - Magnetic landing heading  
 FD - Flight direction

Perform the final turn in horizontal flight at an altitude of no less than 200 m at 150 kph. Initiate the final turn at  $RB = 285 \pm SA$  ( $75^\circ \pm SA$  for right-hand pattern) or upon reaching the required MRB.

Control the turn start and pattern leg flight times based on pattern calculations.

On the base leg nearing the fourth turn to final approach, the bearing needle of the directional gyro will be moving toward the desired course needle (set to magnetic runway heading). At the start of the turn, the angle between the desired course and bearing needles should be 15°. When the turn is executed correctly, the two needles will align approximately 30° prior to reaching final approach course.

Continue the final turn with the desired course and bearing needles aligned.

If during the first half of turn the angle between the bearing needle and the desired course needle is constant or increasing, the angle of roll should be decreased. If after the needles align the bearing needle starts falling behind the desired course needle, the angle of roll should be increased, but by no more than 15°.

After recovering from the final turn, begin to descent at a rate of 2 - 3 m/s and reduce airspeed to pass over the LMM at 100 - 140 kph at an altitude of 100 m. If an altitude of 100 m is reached prior to passing over the locator middle marker, transition to level flight.

If the final turn is recovered on a heading different from the landing course, perform a course correction while on the descent by checking the course deviation angle when the bearing needle is centered directly ahead to the LMM. If the difference exceeds 5°, correct the heading error by turning toward the bearing needle (away from the desired heading needle) such that the bearing needle is set midway between the heading index on the compass card and the desired heading needle. If the course indicator reads a magnetic heading exceeding the landing course, perform the course correction to the right, otherwise perform the course correction to the left.

After starting the course correction, maintain the corrective heading until the bearing needle aligns with the desired heading needle, then turn the helicopter so as to align the bearing needle and the desired heading needle on the landing course over the compass card (or with an angle-off the landing course to account for drift).

In a right drift scenario, maintain the bearing and the desired heading needles aligned along the landing course, but offset to the right along the compass card to correspond to the drift angle.

Maintain the current landing course after passing over the LMM.

When flying the wide rectangle pattern for landing, maintain the landing course after passing over the LMM and execute the first turn to the crosswind leg when the calculated flight time has expired (2 min in calm weather).

### **9.22. Tight rectangle pattern**

When the LMM is approached at an angle of greater than 60°, but less than 120° off from the landing course, use the tight rectangle landing pattern.

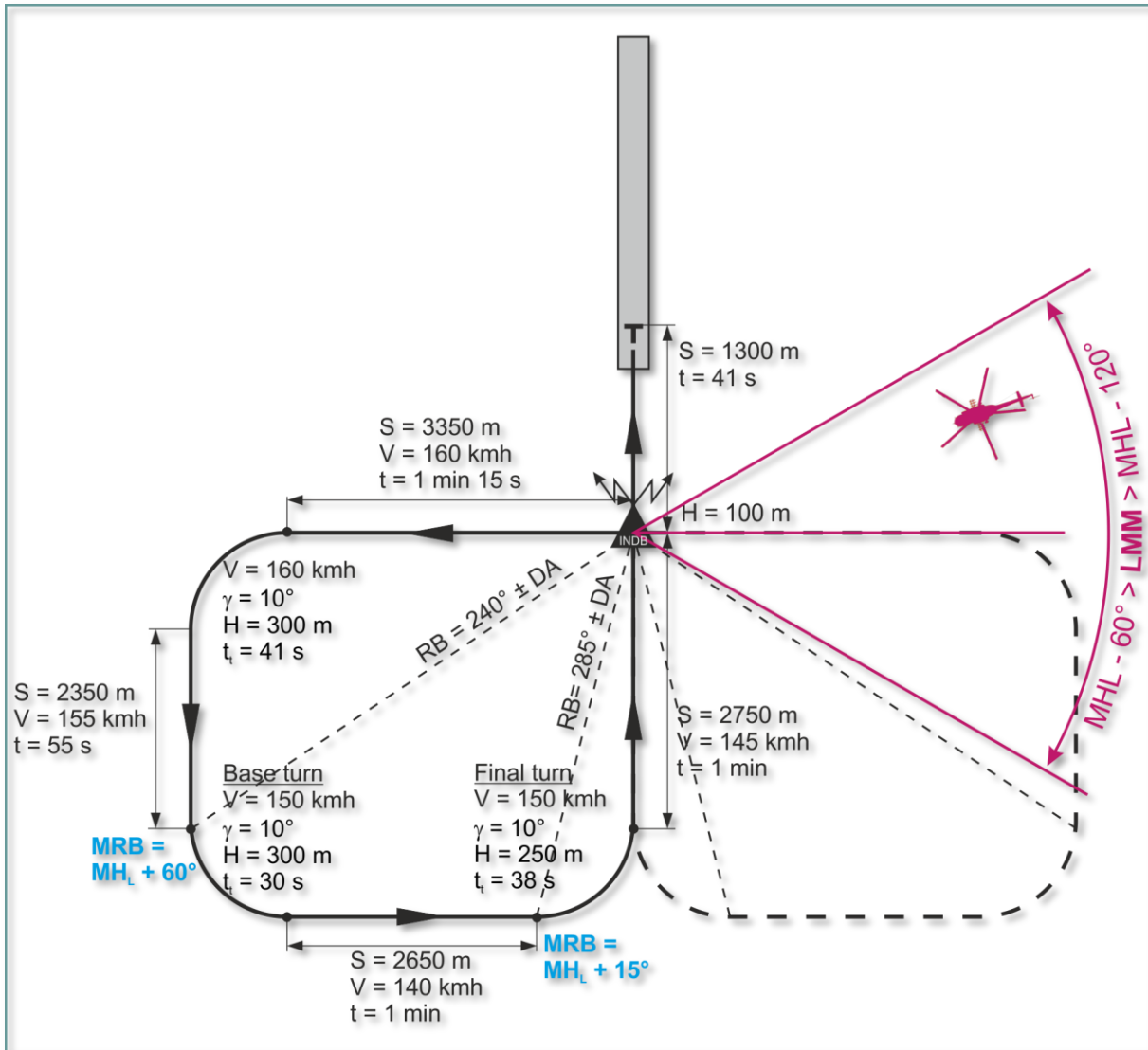

**Fig. 9.7. Tight rectangle pattern diagram**

After crossing the LMM, turn to a heading perpendicular to the landing (runway) heading (estimating the drift angle). After the estimated time has been reached (1 min 15 sec for calm weather conditions), turn to a heading opposite the landing heading and estimate the drift angle. Afterwards, the pattern is to be completed like the big pattern approach.

### 9.23. Straight in approach with teardrop procedure turn

If the LMM is approached on a magnetic heading opposite to the landing course (MHLO) or if the difference does exceed  $60^\circ$ , perform a straight in approach with a teardrop procedure turn.

The magnetic heading, flight time (HFT), and estimated turn angle (ETA) calculations for performing the teardrop procedure turn are prepared in advance taking into consideration approach altitude and anticipated drift angles based on wind conditions. The resulting values are entered into a reference chart:

Procedure	H (altitude), m
-----------	-----------------

elements	300	400	500	600	700	800	900	1000
ETA, deg	28	19	14	12	10	8	7	6
HFT, min:sec	1:30	2:15	3:00	3:45	4:30	5:15	6:00	6:45

*NOTE.* chart assumes calm weather:

$V_{gs} = 160 \text{ km/ч}$ ;  $V_s = 2\text{--}3 \text{ m/s}$ ;  $AGS = 150 \text{ km/ч}$ ;  $\gamma = 10^\circ$

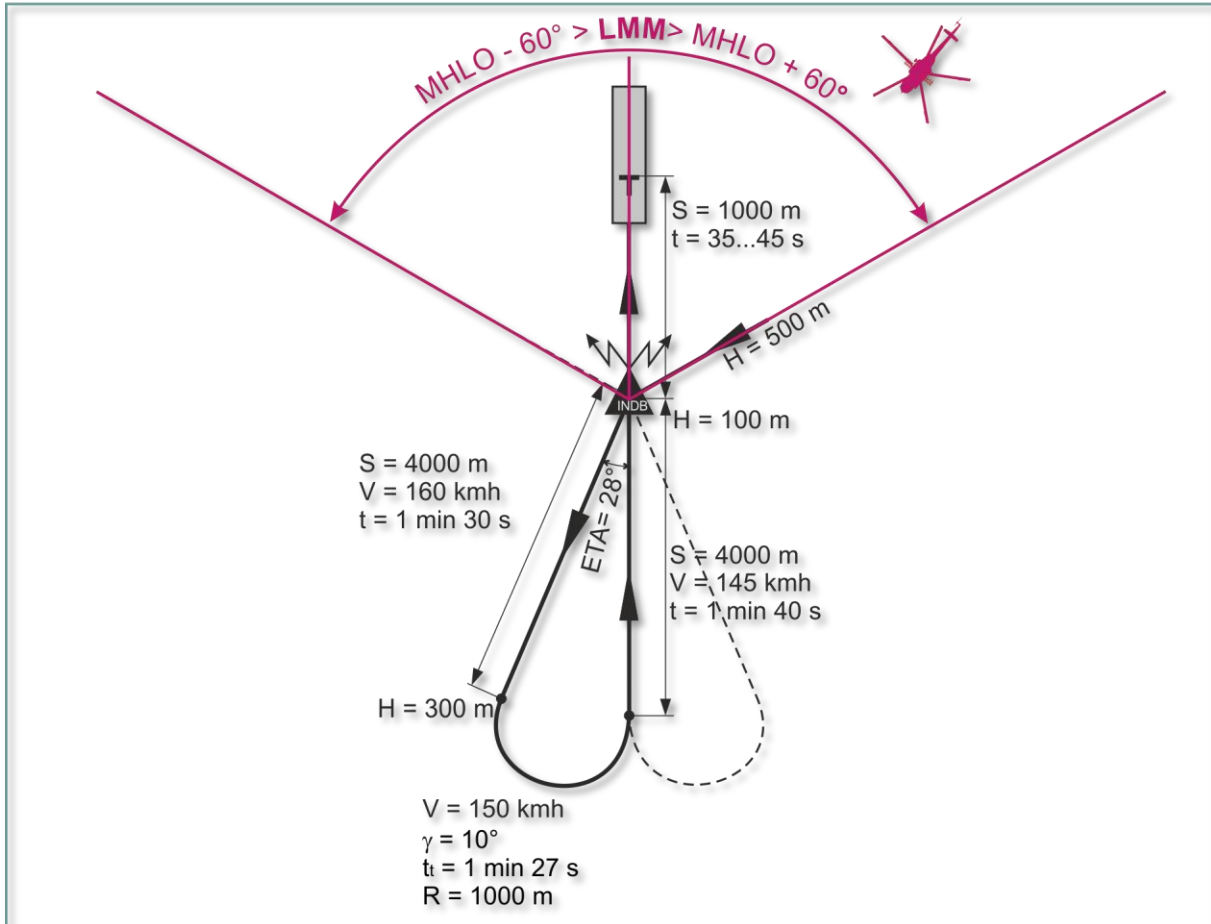

**Fig. 9.8. Straight in approach with a teardrop procedure turn diagram**

When performing a straight-in teardrop approach, navigate to the LMM at a selected altitude. After passing the LMM, execute a right-hand or left-hand procedure turn corresponding to the calculated turn angle (including drift calculation) and continue flying on this heading until reaching the estimated turn to final approach position. When the calculated horizontal leg flight time expires (HFT), proceed to descend at an airspeed of 150 kph and a vertical speed of 2 - 3 m/s, turn to the landing course with a roll angle of  $10^\circ$  and a descent of 200 m. In the final approach, compensate for the drift angle, maintain the desired condition of flight and avoid sideslipping and skidding. Having reached an altitude of 100 m, transition to horizontal flight, passing the LMM at 100 m and an airspeed of 100 - 140 kph.

After breaking through the cloud cover, adjust the helicopter's position on the descent as required and proceed to land.

### **9.24. Special considerations for takeoff and landing operations at high altitudes**

The minimum field dimensions for a vertical takeoff or landing in ground effect with no obstacles are 50 x 50 m. With a 15 m obstacle height, minimum dimensions for the field depend on altitude as follows:

- up to 1500 m: 50 x 120
- 2000 m: 50 x 165
- 3000 m: 50 x 255
- 3500 m: 50 x 300
- 4000 m: 50 x 345

The minimum field dimensions for a running takeoff or landing are:

- up to 1500 m: 50 x 200
- 2000 m: 50 x 225
- 3000 m: 50 x 350
- 3500 m: 50 x 410
- 4000 m: 50 x 475

The minimum dimensions of a field for a single engine running landing at altitudes up to 1500 m are 50 x 190 m if landing speed is 10 - 20 kph and 50 x 360 m if landing speed is 50 kph.

Perform a vertical takeoff with acceleration out of ground effect in cases where the field is of limited dimensions and surrounded with obstacles, and available engine power is insufficient to allow a hover out of ground effect.

Perform a vertical landing with a hover out of ground effect when landing on a field of limited dimensions at helicopter gross weights allowing a hover out of ground effect.

Perform a vertical takeoff with acceleration in ground effect in cases where the available engine power is sufficient to allow a hover at an altitude of no less than 3 m and the field dimensions allow for acceleration in ground effect.

Perform a vertical landing with a hover in ground effect in cases where the field dimensions and approach paths, as well as the available engine power allow for a deceleration and hover in ground effect.

Perform a running takeoff in cases where the available engine power is sufficient for a hover at an altitude of no less than 1 m, and the field surface properties allow a safe takeoff run over a distance of 80 to 100 m and subsequent acceleration in ground effect.

Perform a running landing in cases where the field surface conditions and dimensions allow for a safe execution of this procedure.

In a landing approach for a vertical landing in ground effect, plan the deceleration such that the outer edge of the landing point is reached at an altitude of 2 - 3 m at 5 - 10 kph. Attempt to reach a hover position in the center of the landing point with subsequent assessment of the ground surface and ideal touchdown point. If necessary, approach the desired touchdown point at an airspeed of 5 - 10 kph.



In case of obstacles on the landing approach, plan the approach to allow a minimum altitude of 10 m above obstacle height.

When performing an approach to deliver external sling cargo, plan and begin the deceleration in advance. A high altitude approach with external sling load requires 1.5 - 2 times more distance than a low altitude approach. Aggressive deceleration leads to more difficult flight control and load instability.

### **9.25. Takeoff and landing on an incline**

Landing fields in mountainous terrain typically consist of inclines of various grades.

Incline grade limits for vertical takeoff and landing operations without engine shutdown are:

- nose up incline: 7°
- nose down incline: 5°
- left side up incline: 7°
- right side up incline: 2°30'

Incline grade limits for vertical takeoff and landing operations with engine shutdown are:

- nose up incline/nose down incline/left side up incline: 3°
- right side up incline: 2°30'

Vertical takeoff and landing on an incline in wind speeds up to 5 m/s are permissible from any wind heading. In wind conditions above 5 m/s, vertical takeoff and landing on an incline is permissible only into the wind and within above grade limitation guidelines. Always attempt to perform takeoff and landing from an incline in either a nose or right side up incline position. A nose up incline position is best.

When landing in a down incline position, hover at an altitude of no less than 3 m above ground to avoid striking the tail boom on the ground. Descend to touchdown strictly vertically and avoid any drift, in particular backward.

As the helicopter is hovered 3 m above ground, the height of the tail boom tip from the ground is 0.6 - 0.8 m. At touchdown and liftoff, the height of the tail boom tip is 0.3 m. Aggressive deceleration just prior to achieving a hover position during landing or excessive reduction of collective pitch may lead to the tail boom striking the ground.

When descending to touchdown or taking off from an incline, keep the wheel brakes depressed.

When landing on an incline in a position perpendicular to the slope, adjust cyclic in the up slope direction to avoid drifting down slope. A hover over an incline is maintained with some roll angle.

When lifting off from an incline in a position perpendicular to the slope, climb strictly vertically and avoid any drift or yaw. As the helicopter lifts off, it will exhibit a tendency to roll in the up slope direction, requiring opposite cyclic to compensate and maintain position.

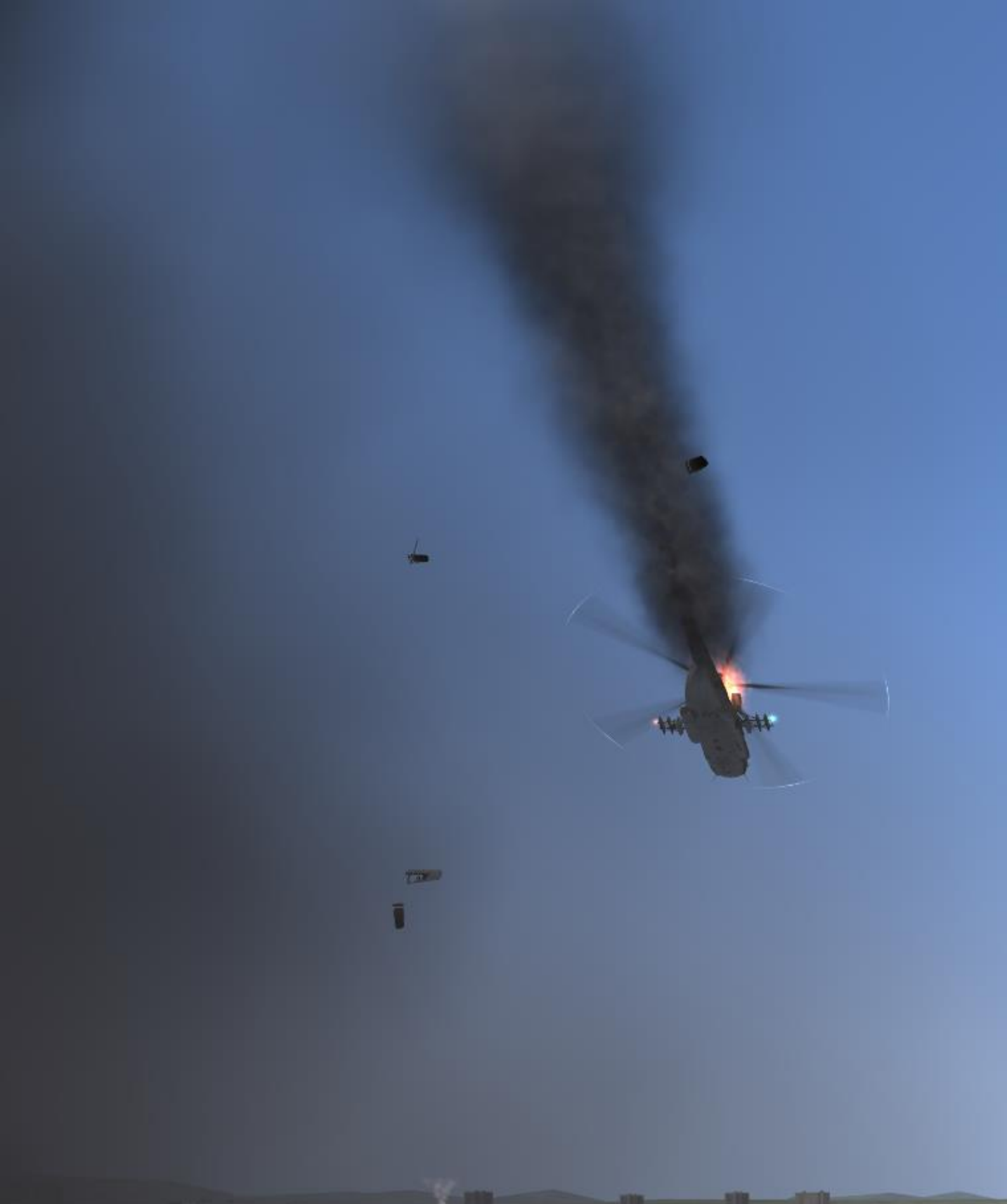

**10**

***EMERGENCY  
PROCEDURES***

## 10. EMERGENCY PROCEDURES

### 10.1. *Single engine failure*

#### Symptoms:

- Uncommanded right yaw, the severity of which depends on the engine power setting and airspeed at the moment of failure (the higher the engine power setting and the lower the airspeed, the stronger the effect);
- Drop of compressor RPM and EGT of the failed engine;
- Increase of compressor RPM of the operating engine;
- Drooping of main rotor RPM;
- Illumination of the **ЧР. ЛЕВ. (ПРАВ.) ДВ.** (EMER PWR LFT (RGT) ENG) light depending on the helicopter's weight and altitude at the moment of failure.

#### 10.1.1. Crew actions in case of a single engine failure at an altitude above 100 m:

- Reduce the collective pitch to maintain main rotor RPM no less than 92%;
- Use cyclic and pedal control to correct uncommanded roll and yaw;
- Accelerate or decelerate as required to an airspeed of 120 kph;
- Determine which engine has failed by observing the instrumentation;
- Order the crew chief to close the fuel shutoff lever and the fire valve of the failed engine;

#### WARNING

When closing the fuel shutoff levers and fire valves, use extreme caution not to shut down the operating engine!

- Having reached an airspeed of 120 kph, operate the collective to set the operating engine to a power setting sufficient to maintain level flight;
- Make sure engine performance is adequate and sufficient to maintain level flight. Navigate to the nearest airfield or find a suitable landing location;
- Prior to landing, check the helicopter weight.

#### NOTE

1. In case of a single engine failure, the power setting of the remaining engine is automatically increased by the electronic engine governor (EEG) system all the way up to emergency power, depending on helicopter weight.

2. In case of EEG failure in flight, the remaining engine is not automatically set to emergency power.

Crew actions if helicopter weight is under 12000 kg

- Performing a gliding descent, maintain airspeed 20 kph higher than current altitude until reaching an altitude of 40 m.

- At an altitude of 40 m, begin to reduce airspeed by pulling the cyclic aft to attain an airspeed of 40 kph at an altitude of 5 m with a vertical descent rate of 2 - 3 m/s;
- At an altitude of 5 - 7 m, establish a landing attitude;
- From an altitude of 3 - 5 m, reduce vertical speed by increasing collective pitch at a rate of 2 - 4°/sec. When increasing collective pitch, softly press the right pedal to counter induced left yaw. Use the cyclic to maintain the landing pitch angle. While increasing collective pitch, do not allow rotor RPM to droop below 70%;
- Land at a speed of 30 kph;
- After landing, immediately proceed to smoothly lower collective to minimum and simultaneously push the cyclic 1/3 - 1/4 travel forward to prevent the main rotor blades from striking the tail boom.
- After nose wheel touchdown, apply the wheel brakes.

Crew actions if helicopter weight is greater than 12000 kg

The following particulars must be taken into account:

- The airspeed on the glideslope must be controlled such that 60 - 70 kph is maintained as the helicopter reaches an altitude of 5 - 10 m;
- Land at a speed of 50 kph;
- Before landing, make sure the rotor RPM is no less than 88%.

#### NOTE

If at the moment of engine failure the airspeed is less than 120 kph and during acceleration to an altitude of 10 - 20 m the helicopter does not reach sufficient airspeed to allow level flight with a single engine operating in emergency power setting, transition to a rapid vertical and forward deceleration to perform a landing as described above.

#### **10.1.2. Crew actions in case of a single engine failure at an altitude below 100 m**

- Reduce collective pitch to maintain rotor RPM no less than 92% and ensure the remaining engine attains increased (emergency) power setting;
- Use cyclic and pedal control to correct uncommanded roll and yaw;
- If airspeed is above 120kph, begin to decelerate and climb by increasing helicopter pitch to 10 - 15°;
- Determine which engine has failed by observing the instrumentation;
- Order the crew chief to close the fuel shutoff lever and fire valves of the failed engine;
- Having reached an airspeed of 120 kph, operate the collective to set the operating engine to a power setting sufficient to maintain level flight;
- Make sure engine performance is adequate and sufficient to maintain level flight;
- When the airspeed is stabilized, navigate to the nearest airfield or find a suitable landing location;

If at the moment of engine failure the airspeed is less than 80 kph, actions are as follows:

- Reduce collective pitch to maintain main rotor RPM no less than 92% and ensure the remaining engine attains increased (emergency) power setting;
- Use cyclic and pedal controls to correct uncommanded roll and yaw;
- Accelerate or decelerate as required to an airspeed of 40 - 60 kph, depending on helicopter weight;
- Begin to descend with a vertical speed not exceeding 3 - 4 m/s;
- Descend to the chosen airfield;
- Land.

## **10.2. Dual engine failure (Autorotation landing)**

Symptoms:

- Uncommanded right yaw, the severity of which depends on the airspeed at the moment of failure (the higher the engine power setting and the lower the airspeed, the stronger the effect);
- Change in the cockpit sound of the powerplant;
- Rapid drop of the main rotor RPM;
- Drop of RPM and EGT of both engines.

### **10.2.1. Crew actions in case of dual engine failure at an altitude above 100 m:**

- Immediately reduce collective pitch to minimum;
- Use cyclic and pedal control to correct uncommanded roll and yaw;
- Close the engine fuel shutoff levers. Order the crew chief to close the fire valves, turn off the boost and transfer pumps;
- Accelerate or decelerate to reach the indicated glide speed of 100 - 120 kph;
- Maintain main rotor RPM at maximum, i.e. 90 - 100% by observing the indicator and adjusting collective control to avoid peaks over 110% and droops under 88%;
- Jettison all external payload in order to reduce weight;
- Trim the helicopter to set a shallow dive, use cyclic control to counter the rolling moment;
- Find a suitable airfield and perform an upwind approach if possible;
- If altitude allows, the approach can be adjusted using collective control while maintaining rotor RPM within permissible limits;
- At an altitude of 70 - 100 m, slightly and smoothly adjust cyclic control to set and maintain a constant airspeed of 100 kph for a running landing or 70 kph for a vertical landing;
- Starting from an altitude of 50 - 70 m, use the ground to visually gauge and control altitude above the landing point. Use cyclic control to maintain helicopter pitch;



- Starting from an altitude of 10 - 15 m for a running landing or 15 - 20 m for a vertical landing, increase collective pitch to 7 - 8° (perform a flare within approximately 1 sec) and maintain it for 0.5 - 1 sec. If this is not sufficient to reduce the vertical speed, increase collective pitch to 12° (within 1 - 1.5 sec) to reduce vertical speed further;
- During the flare and with a collective pitch increase rate of 10°/sec, increase the pitch angle to 5 - 6° in order to reduce forward airspeed for a running landing or to 8 - 10° for a vertical landing. Maintain the pitch angle by slightly pushing the cyclic forward;
- After landing, set collective pitch to 7 - 8° and maintain it until the landing run is complete and the helicopter is stopped;
- Pull back the cyclic to maintain the required pitch angle during landing until nose gear touchdown, then smoothly push the cyclic forward 1/3 - 1/4 travel and apply the wheel brakes.

#### NOTE

1. If the selected landing field is off course from the flight path or the approach heading must be changed due to wind conditions, perform the required maneuver (provided sufficient altitude is available).
2. For an autorotation landing with a 180° turn (with a roll angle of 15°) altitude must be at least 650 m.

### **10.2.2. Crew actions in case of dual engine failure at an altitude of 100 m and below**

If the airspeed is close to 70 kph at the moment of dual engine failure, immediately reduce collective pitch to maintain rotor RPM of 90 - 100%. Set a gliding speed of 70 kph for a running landing or as described above for a flare maneuver for a vertical landing in case of a dual engine failure at an altitude above 100 m. After touchdown, during the landing roll, order the crew chief to close the fuel shutoff levers and fire valves, switch off the boost and transfer pumps, and turn off all electrical power;

If the airspeed is more than 120 kph at the moment of dual engine failure, immediately reduce collective pitch to maintain main rotor RPM of 88% and simultaneously decelerate by setting helicopter pitch up to 20° depending on airspeed and altitude (the greater the airspeed and the lower the altitude, the higher the pitch angle) above which the engines had failed. Increase collective pitch to keep main rotor RPM under 110%.

Close the fuel shutoff levers of both engines. Use cyclic and pedal control to correct any uncommanded roll and yaw.

If altitude allows for a quick deceleration to 70 kph, balance the helicopter at this speed, then follow the above recommendations. If altitude is insufficient, maintain helicopter pitch until ready to flare (fast pitch-up) at an altitude of 15 - 20 m.

If both engines fail in a hover, crew actions are the same as in the case of a single engine failure, but keep in mind that in a hover, yaw instability, drop of main rotor RPM, and transition to an uncontrolled descent are more abrupt due to the high engine power settings required for hover.

## CAUTION

In case of dual engine failure, a safe landing can be performed only on a firm and level surface. Landing in any other conditions may cause damage to the helicopter.

### **10.3. Onboard fire**

Symptoms:

- Illumination and flashing of red fire lights **ПОЖАР** (FIRE) on Left Instrument Panel;
- Illumination and flashing of red fire lights **ПОЖАР ЛЕВ. ДВ.** (FIRE LFT ENG) or **ПОЖАР ПРАВ. ДВ.** (FIRE RGT ENGINE), **ПОЖАР КО-50** (FIRE KO-50) or **ПОЖАР РЕД. ВСУ** (FIRE XMSN/APU), depending on where the fire has been detected;
- Presence of smoke, fire (not implemented in simulation);
- Illumination of the amber light **I ОЧЕРЕДЬ** (1<sup>ST</sup>/MAIN DISCH) corresponding to the compartment where a fire has been detected, upon automatic initiation of discharge of the first extinguisher.

#### **10.3.1. Crew actions in case of onboard fire:**

a) In case of fire in the left (right) engine:

- Close the fuel shutoff lever of the affected engine;
- Order the crew chief to close the fire valve of the left (right) engine and confirm that the first fire extinguisher has been automatically discharged;
- Abort the mission and find an airfield to land.

## WARNING

After the fire has been extinguished, attempting to restart the affected engine is prohibited.

b) In case of a gearbox or APU fire:

- If the APU is operating, shut it down;
- Confirm that the first fire extinguisher has been automatically discharged.

c) If the automatic system fails (the **I ОЧЕРЕДЬ** (1<sup>ST</sup> DISCH) light is not illuminated), engage it manually by pressing the **РУЧНОЕ ВКЛЮЧЕНИЕ I ОЧЕРЕДЬ** (MANUAL 1<sup>ST</sup> DISCH) button for the corresponding compartment.

If the fire has been eliminated, then within 10 seconds from the moment of the first discharge the **ПОЖАР ЛЕВ.ДВ** (FIRE LFT ENG) (or **ПОЖАР ПРАВ.ДВ.** (FIRE RGT ENG), **ПОЖАР КО-50** (FIRE KO-50), **ПОЖАР РЕД. ВСУ** (FIRE XMSN/APU) – depending on where the fire has occurred) lights will go off while the **I ОЧЕРЕДЬ** (1<sup>ST</sup>/MAIN DISCH) light will remain on confirming that the first extinguisher has been discharged.

If the fire has not been eliminated by the first discharge (the **ПОЖАР ЛЕВ ДВ.** (FIRE LFT ENG) or **ПОЖАР ПРАВ. ДВ.** (FIRE RGT ENG), etc. light remains on), manually initiate the second discharge by pressing the **РУЧНОЕ ВКЛЮЧЕНИЕ II ОЧЕРЕДЬ** (MANUAL 2<sup>ND</sup> DISCH) button for the corresponding compartment.

If the first discharge eliminated the fire, but left signs of fire in another compartment, press the **РУЧНОЕ ВКЛЮЧЕНИЕ II ОЧЕРЕДЬ** (MANUAL 2ND DISCH) for the corresponding compartment.

#### NOTE

To turn off all electrical power:

Set the **ГЕНЕРАТОРЫ 1, 2** (GENERATOR 1, 2) switches to neutral (center position);

Turn the switches **АККУМУЛЯТОРЫ 1.2** (BATTERY 1, 2) to **ОТКЛ.** (OFF);

If the **СТГ-3** starter generator is ON, set the **РЕЗЕРВ ГЕНЕР** (STBY GEN) switch to **ОТКЛ.** (OFF).

#### CAUTION

After eliminating of fire, abort the mission. If the fire persists, start immediate landing with a parachute (depending on the situation) – **not implemented in simulation.**

## **10.4. Engine Malfunction**

### **10.4.1. Automatic Control System Malfunction**

There are two types of Engine Automatic Control System Malfunctions.

**Type 1:** N1 split of 2% or more, 3% at maximum power with temp regulator operating, and/or engine power fails to change during collective movement with Nr stable at  $95 \pm 2\%$ .

1. Land as Soon As Practical

**Type 2:** N1 split greater than 2% with spontaneous increase of Nr above  $95 \pm 2\%$ .

If on takeoff or final approach:

1. Smoothly rotate throttle to left and increase collective to maintain  $95 \pm 2\%$  Nr.

For other phases of flight.

1. Increase collective to maintain  $95 \pm 2\%$  Nr.
2. Determine malfunction by moving collective down then up (maintain Nr < 98%). Resulting engine indications determine what procedures to follow:

- Case 1: N1 varies in both engines, Nr maintains  $95 \pm 2\%$ .
  - 1. Maintain 55-80 KIAS (100-150 kph)
  - 2. Land as Soon as practical
- Case 2: N1 varies in one engine, other engine at takeoff power, Nr maintains  $95 \pm 2\%$ .
  - 1. Reduce ECL of engine at takeoff power
  - 2. Maintain 55 - 80 KIAS (100-150 kph)
  - 3. Land as Soon as practical

- Case 3: N1 varies in one engine, other engine at take off power, Nr does not maintain  $95 \pm 2\%$ . (increases as collective is lowered and droops as collective is raised)
  - 1. Adjust throttle to maintain  $95 \pm 2\%$  Nr
  - 2. Maintain 55 - 80 KIAS (100 - 150 kph)
  - 3. Land as Soon as practical

#### 10.4.2. Abnormal Engine Vibration

Engine vibration is a significant indicator of potential catastrophic engine failure. Verify which of the following indications are applicable and respond accordingly

A. Indications:

1. Amber HI VIBE light is illuminated
2. Red SHUT DOWN ENGINE light is illuminated.

B. Procedure:

1. HIGH VIBE LFT/RGT ENG Light On
  - a. Monitor engine
  - b. continue with mission
2. SHUT OFF LFT/RGT ENG Light On
  - a. Reduce power
  - If light goes out:
    - b. Establish 70 - 75 KIAS (130-140 kph)
    - c. Land as soon as practical
  - If light stays on:
    - d. Shut down engine (If you do not, possible engine fire after 30s )
    - e. Refer to Single Engine Failure Procedure ([10.1](#))

#### 10.4.3. Low Engine Oil Pressure

If oil pressure is between 2-3 kgf/cm<sup>2</sup>:

- 1. ECL - Reduce (Affected engine)
- 2. Engine oil pressure – Monitor
- 3. Land As Soon As Practical

If oil pressure drops below 2 kgf/cm<sup>2</sup> or oil temp exceeds 150°C:

- 1. Shut down engine
- 2. Refer to Single Engine Failure Procedure

#### 10.4.4. Failure of electronic engine governor (EEG) power turbine channels

Symptoms:

- Illumination of the yellow **ПРЕВ.нст ЛЕВ ДВ.** (HIGH N2 LFT ENG) or **ПРЕВ. нст ПРАВ ДВ** (HIGH N2 RGT ENG) light on the left instrument panel;
- the engine does not shut down.

Crew actions:

- Temporarily switch off the EEG of the affected engine;
- Check the **ПРЕВ.нст ЛЕВ. (ПРАВ.) ДВ.** (HIGH N2 LFT (RGT) ENG) light to extinguish;
- Switch on the EEG;
- If the EEG light does not illuminate after resetting the EEG, check engine operation indicators for normal readings and if no further faults are found, continue the mission paying particular attention to the engine performance parameters;
- If the EEG light illuminates once again and remains on, abort the mission and land at the nearest airfield, paying particular attention to the engine performance parameters.

#### **10.4.5. Failure of electronic engine governor (EEG)**

Symptoms:

- Illumination of the **ОТКЛ.ЭРД ЛЕВ ДВ.** (GOV OFF LEFT ENG) or **ОТКЛ.ЭРД ПРАВ.ДВ.** (GOV OFF RGT ENG).

Crew actions:

- Switch OFF the failed EEG;
- Continue the mission paying particular attention to engine performance parameters.
- With a failed (switched off) EEG, the compressor RPM must not exceed 102.5%.

### ***10.5. Main/Intermediate/Tail Rotor Gear Box Malfunction***

Main Transmission Malfunction or Failure Main transmission malfunctions normally precede catastrophic failure. Early failure indications may vary, depending on the nature of the problem and the severity of failure. If a malfunction is encountered, begin immediate descent at 70 - 75 KIAS and execute either a vertical or roll-on landing as soon as possible. Indications and actions to be taken in the event of a main transmission malfunction are as follows:

INDICATIONS:

- Unusual Noise or Shaking of Aircraft
- Transmission Oil Temperature above normal range (see [Table 8.8](#))
- Transmission CHIP light illuminated
- Transmission Oil Pressure below normal operating range
- Transmission Oil Pressure warning light illuminated.

Malfunctions in the drive line can be experienced in either the electronic synchronisation system or as a mechanical problem in any of the dynamic



components. Nr irregularities, vibrations, oil over temperature or excessive main gearbox pressure are the basic indications of drive line problems.

## **10.6. Yaw control failure**

Symptoms:

- If the tail rotor or its transmission are damaged in flight, the helicopter exhibits an abrupt left yaw, right roll, and negative pitch.

Crew actions:

- Immediately reduce collective pitch and, if altitude is sufficient, order the crew to eject from the helicopter.
- If altitude is not sufficient for the crew to eject, crew actions are:
  - Begin an autorotation descent; maintain heading by setting a roll angle to the side opposite of the turning tendency;
  - Balance the helicopter with sideslip as required; compensate the yaw moment with lateral cyclic control;
  - Find an airfield to land;
  - Shut down the engines by closing the fuel shutoff levers;
  - Close the fire valves, close the boost and transfer pumps (if possible);
  - Perform an autorotation landing. Before landing, set a zero roll attitude for touchdown.

If the actuator of the tail rotor is operative, but the cockpit controls are damaged (the helicopter does not respond to pedal inputs), establish an airspeed of 120 - 130 kph, adjust collective as required to establish level flight or a shallow descent and proceed to an airfield that can be used for a safe landing. Balance the helicopter with sideslip as required. Execute a running landing. It is PROHIBITED to increase collective pitch before touchdown to avoid unbalancing the helicopter.

If yaw control fails in hover or while moving at low altitude, crew actions are:

- Immediately smoothly reduce collective pitch and descend to touchdown;
- During the descent, press the right pedal and deflect the cyclic to the right to counter left turn and left drift; pull the cyclic aft to counter the negative pitch;
- At the moment of touchdown by the main wheels, immediately and rapidly minimize collective pitch and shut down the engines.

## **10.7. Hydraulic system failure**

### **10.7.1. Failure of main hydraulic system**

Symptoms:

- The red **ДУБЛИР.ВКЛЮЧЕНА** (B/U SYS ON) light on the center overhead console illuminates and starts flashing while the **ОСНОВН. ВКЛЮЧЕНА** (MAIN SYS ON) extinguishes;

- The pressure in the main hydraulic system drops down below 42 kgf/cm<sup>2</sup>, while the pressure in the backup hydraulic system grows up to 42 - 73 kgf/cm<sup>2</sup>.

Crew actions:

- Set the **ОСНОВН ГИДРОСИСТЕМА** (MAIN HYD) switch to to **ВЫК** (OFF).

NOTE

Switching to the backup system disengages the AP-34B autopilot and the collective clutch release system. In this case, collective handle friction force can be adjusted manually using the friction hand wheel (not implemented in simulation).

- Disengage the autopilot by pressing the autopilot disconnect button on the cyclic control stick;
- Abort the mission. With a particular attention to the hydraulic system, perform landing in the nearest airport or onto a chosen airfield.

### 10.7.2. In case of failure of both main and backup hydraulic systems

- Eject from the helicopter (not implemented in model).

## 10.8. Uncommanded left yaw during takeoff or landing

### 10.8.1. During a hover check before takeoff

Symptoms:

- The helicopter does not respond to right pedal input up to full deflection and continues to yaw left;
- Main rotor RPM droops below the lower limit due to a sharp increase of collective pitch angle.

Crew actions:

- Immediately decrease collective pitch by 1 - 2° to counter uncommanded roll and pitch;
- Disengage the SPUU-52 tail rotor pitch limit system;
- Descend to touchdown;
- At the moment of touchdown rapidly lower collective to minimum and order the crew chief to shut down the engines, close the fire valves, and turn off all electrical power.

### 10.8.2. During a hover before landing

Symptoms:

- The helicopter does not respond to right pedal input up to full deflection during final deceleration to hover prior to landing and continues to yaw left;

- Main rotor RPM droops below the lower limit due to a sharp increase of the collective pitch angle during final deceleration to hover prior to landing;
- While turning, the helicopter loses altitude with uncontrollable evolutions in roll and pitch.

Crew actions:

In a hover at an altitude below 10 m

- Immediately decrease collective pitch by 1 - 2° to counter uncommanded roll and pitch;
- Disengage the SPUU-52 tail rotor pitch limit system;
- Descend to touchdown;
- At the moment of touchdown rapidly lower collective to minimum and order the crew chief to shut down the engines, close the fire valves, and turn off all electrical power.

In hover at an altitude above 10 m

- While applying full right pedal, quickly decrease collective pitch by 1 - 2° and simultaneously push the cyclic forward and left to correct uncommanded roll and pitch angles; transition to forward flight;
- Disengage the SPUU-52 tail rotor pitch limit system;
- Execute a go-around;
- Repeat the landing approach and perform a running landing.

### **10.9. Vortex ring state (VRS)**

The helicopter is susceptible to VRS in a vertical descent of greater than 3 m/s or in a powered glide with a forward airspeed of less than 40 kph and a vertical speed of more than 4 m/s.

Symptoms:

- Uncommanded rapid increase of vertical speed;
- Abrupt attitude changes and severe vibrations;
- Loss of flight control effectiveness;
- Unstable readings of airspeed and vertical speed indicators.

Crew actions:

- Push the cyclic forward to establish a nose-down pitch of -10 to -20°, increase collective to set engine power up to takeoff setting and begin to transition into forward flight while avoiding drooping main rotor RPM below 92%;
- Having reached an airspeed of 60 - 80 kph, transition to level flight.

NOTE

1. A transition out of a vortex ring state to level flight may require 50-200 m of altitude loss, depending on:

- initial forward speed at the moment of entry into VRS;
- the vertical descent rate at the moment of exiting VRS;

- forward acceleration rate (pitch angle for dive) and increase of engine power;
  - helicopter weight;
  - free air temperature and pressure.
2. If the helicopter does not exit VRS quickly, vertical speed may reach 20 m/s.
  3. The pitch angle used in the acceleration out of VRS depends on the altitude of VRS exit.







## 11. ARMAMENT SYSTEMS

The armament systems of the Mi-8MTV2 helicopter include unguided rockets, cannon and machine guns, free-falling bombs, and airborne minelaying systems (not implemented in simulation) in various payload configurations.

The weapons control system is designed to provide weapon firing/release stations, control of weapon fire modes, and weapons employment. The weapons control system includes the following components ([Fig. 11.1](#) и [Fig. 11.2](#)):

- External weapon stations (6 BDZ-57KrV (БДЗ-57КрВ equipped with "ПУС" (PUS) fire control devices (FCU))
- Circuit breakers and switches operating weapons indication and control systems
- Pilot's upper and lower armament control panels
- Copilot's bombs control panel
- ESBR-3P/A (ЭСБР-3П/А) electrical release control box
- Mine release control panel (not implemented in simulation)
- Fire control panel for the PKT (ПКТ) nose-mounted machine gun (not implemented in simulation)
- PKV (ПКВ) collimating sight (pilot)
- OPB-1r (ОПБ-1р) optical bombing sight (copilot) (not implemented in simulation)
- Weapons fire switches on each cyclic control handle, bomb release triggers on the OPB-1r (ОПБ-1р) optical bombing sight and two KSB-49 (КСБ-49) remote bomb release triggers
- S-13 gun camera
- The following weapon sub-systems:
  - a) [unguided rocket system](#): B8V20-A (Б8В20-А) rocket launchers (pods) firing 80 mm unguided rockets with various warhead types;
  - b) [cannon pod system](#): UPK-23-250 (УПК-23-250) gun pods equipped with GSh-23L (ГШ-23Л) twin-barrel 23 mm cannon;
  - c) [machine gun pod systems](#): GUV-8700 (ГУВ-8700) gun pod (index 9-A-669) equipped with either YakB-12.7 (ЯкБ-12.7) (index 9-A-624) and GShG-7.62 (ГШГ-7.62) (index 9-A-622) machine guns or with the AGS-17 (АГС-17) (index 9-A-800) grenade launcher;
  - d) [free-falling bomb systems](#): 100, 250 и 500 kg bombs and incendiary containers (not currently implemented);
  - e) minelaying system: K-29 mine containers with 29 mine canisters of various types (currently not implemented).



Fig. 11.1. Elements of the weapons control system in the cockpit.

### **11.1. External weapon stations**

The Mi-8MTV2 is equipped with an external hardpoint rack consisting of 6 БДЗ-57КрВ (BDZ-57KrV) weapon stations and integrated ПУС (PUS) fire control devices (FCU). The stations are designed to carry and provide electrical commands to loaded weapon systems. The hardpoints are numbered 1 – 6 left to right (facing forward in the cockpit). Stations 1, 3, 4, 6 are equipped with ПУС-36-71 (ПУС-36-71) type FCUs, which are used to control the firing of S-8 unguided rockets at an interval of 0.05 sec for each rocket launcher. ПУС 1 FCU controls rocket fire from stations 1 and 2 ([Fig. 11.2](#)); ПУС 6 FCU from stations 5 and 6, ПУС 3 FCU from station 3, and ПУС 4 FCU from station 4. Readiness of the corresponding FCU to support rocket fire is indicated in the cockpit by the ПУС FCU lights on the pilot's upper weapons control panel.

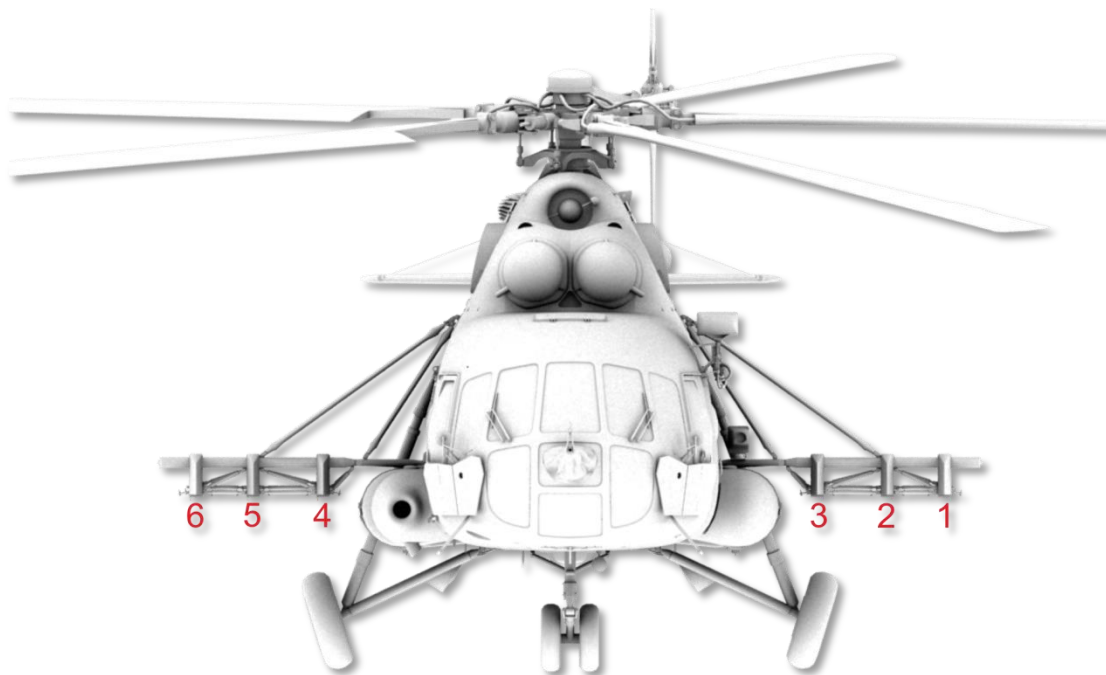

**Fig. 11.2. External weapon stations**

### **11.2. Circuit breakers and switches operating Weapons Indication and Control systems**

The weapons system circuit-breakers, located at the top left of the Circuit-Breaker Panel, are designed to protect the weapon system circuits from a short-circuit. ([Fig. 11.3](#))





**Fig. 11.3. Weapons Systems circuit-breakers.**

**MASTER ARM.** The master arm switch (in EN-cockpit of the Game – SAFETY SWITCH WEAPONS) connects weapon systems circuits to the weapons fire (release) switches on the pilot controls (not to be confused with the main power switches of weapon sub-systems, which connect specific weapon system components to the electrical power system). With the Master Arm switch off, it will not be possible to fire (release) weapons. This is a safety precaution required for safe ground operations with the ground crew and weapons preparation.



**Fig. 11.4. The Master Arm switch and its associated red caution lamp.**

## 11.3. Pilot's Upper and Lower armament Control Panels

### 11.3.1. Upper armament Control Panel

The pilot's upper armament control panel (Fig. 1.5) provides indication of weapon readiness status, control of the RKT-GUN MASTER switch and MINELAYING SYSTEM MASTER switches (not currently implemented), payload jettison, arming of the fire control units (FCU), PKV (ПКВ) collimating sight brightness, and amount remaining of 12.7 mm, 7.62 mm, 23 mm rounds or 30 mm grenades.

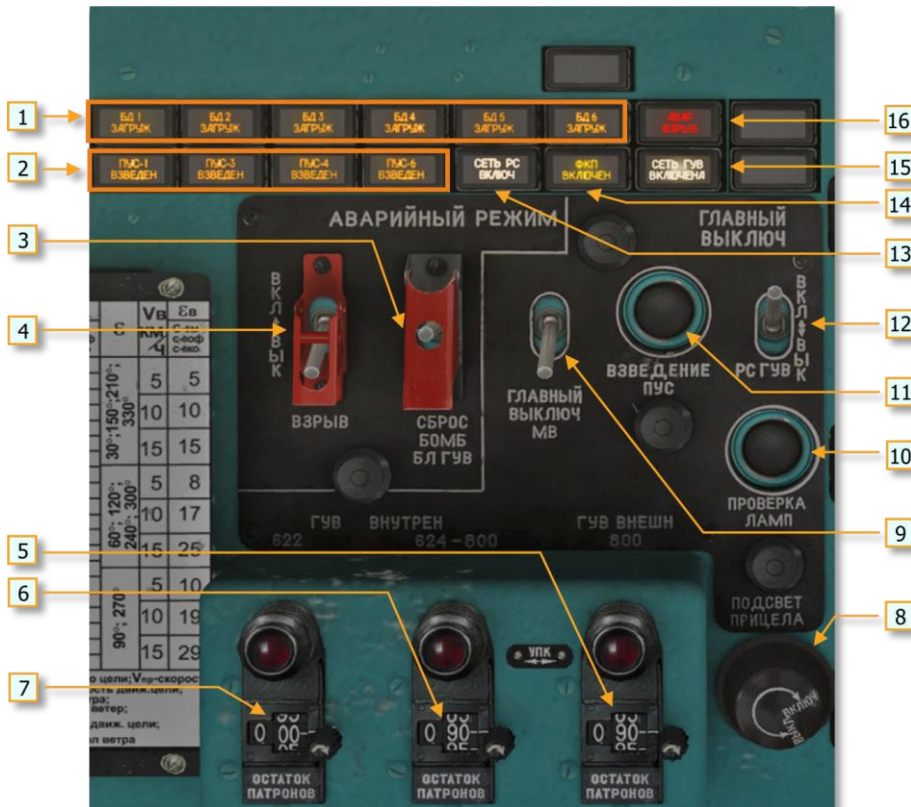

Fig. 11.5. Pilot's upper weapons control panel

1. Stations loaded indication lights
2. PUS (ПУС) Fire Control Unit (FCU) armed indication lights
3. Aircraft Commander's Emergency Jettison switch (releases all stores)
4. Jettison ARMED/UNARMED switch
5. Right-side UPK (УПК) rounds remain counter if UPK is loaded ( or grenades if mixed load)
6. Left-side UPK (УПК) rounds remain counter if UPK is loaded (or 12.7 mm GUV (ГУВ) rounds if mixed load)
7. 7.62 mm GUV (ГУВ) rounds remain counter
8. Gun sight brightness control
9. MINELAYING SYSTEM MASTER switch (in EN-cockpit of the Game – MASTER POWER)
10. Aircraft Commander's Weapons Control Panel Lamp Test
11. ВЗВЕДЕНИЕ ПУС (FIRE CONT UNIT ARM) button
12. RKT-GUN MASTER switch (in EN-cockpit of the Game – MAIN SWITCH)
13. Unguided Rockets electrical circuit ON light
14. Gun camera ON light (not implemented)
15. GUV (ГУВ) gun pod electrical circuit ON light.
16. Jettison Armed light

**1. Stations loaded indication lights.** Indicate presence of weapons on corresponding stations.



2. **FCU armed indication lights.** FCU are installed on stations 1, 3, 4, 6. The lights indicate readiness to launch rocket from tube #1 of launcher. (FCU 1 for stations 1, 2; FCU 3 for station 3, FCU 4 for station 4, FCU 6 for stations 5, 6).
3. **Pilot's Emergency Jettison switch.** Used to quickly lighten the helicopter's gross weight in special circumstances, such as emergency landing or in case the standard bomb release mechanisms fail.

**N O T E .** The pilot's emergency jettison switch released stores loaded on ALL the weapon stations, unlike the copilot's emergency jettison switch, which releases stores according to the selected payload profile set on the copilot's weapons configuration panel. For example, if profile I is set on the weapons configuration panel, an emergency jettison attempt by the copilot will not release any stores, because profile I corresponds to a rocket pod configuration on all weapon stations. To release any stores by the copilot's emergency jettison switch, the payload profile selector must be set to profile II.

4. **Jettison ARM/UNARM switch.** Set to "БКЛ" (ARM) to jettison bombs armed. If a mixed payload is loaded (such as bombs and rockets), both bombs and rocket pods will jettison, but the bombs will detonate upon impact.
5. **Right Rounds Remain Counter.** Displays number of 23 mm UPK rounds remaining in the right UPK container or total number of grenades depending on loaded weapon system.
6. **Center Rounds Remain Counter.** Displays the number of 23 mm UPK rounds remaining in the left UPK container or total number of 12.7 mm GUV rounds depending on loaded weapon system.
7. **Left Rounds Remain Counter.** Displays number of 7.62 mm rounds remaining.

**NOTE.** The rounds remaining counters display the actual number of remaining rounds as follows:

- UPK: actual number divided by 2 (for example counter display of 100 means 200 rounds remain)
- 9-A-624: actual number divided by 5 (for example counter display of 10 means 50 remain)
- 9-A-622: actual number divided by 4
- grenade launcher: displays to actual number of grenades remaining

8. **Gunsight Brightness Control.** Controls PKV reticle brightness. Set to 50% by default.
9. **MINELAYING SYSTEM MASTER switch** (Minelaying System is not implemented).
10. **Lamp Test Button.** Tests the lights installed on the pilot's upper weapons control panel.
11. **FCU Arm Button.** Prepares the rocket launchers (pods) for opening fire: after the button is pressed the first moveable contact PUS-36-71 (FCU) gets set to initial position – first rocket will be launched from the #1 tube. FCUs are energized if the RKT-GUN MASTER switch is set to ON (up), the corresponding circuit breakers are turned on, the UPK-PKT-RKT switch is set to RKT, and the rocket station selector switch is set to AUTO or stations currently loaded with rockets. The button should be pressed until "ПУС..ВЗВЕДЕН" (FCU armed) indication light appear.

- 12. RKT-GUN MASTER switch.** Primarily intended to prevent unintended weapons fire. Set to ON (up) during the target attack run. The switch powers rockets, UPK-23-250 and GUV-1 fire circuits, FCU energized indication (lights), and stations loaded indication (lights).
- 13. RKT CIRCUIT light.** Illuminates if the RKT-GUN MASTER switch (12) and MASTER ARM switches are ON ([Fig. 11.4](#)).
- 14. GUN CAM light.** Illuminates if the gun camera system is turned on.
- 15. GUV CIRCUIT light.** Illuminates if GUV payload profile is set on the copilot's weapons configuration panel and the MASTER ARM switch is ON ([Fig. 11.4](#)).
- 16. JETT ARM light.** Illuminates if the JETTISON ARM/UNARM switch is set to ARM.

### 11.3.2. Lower armament Control Panel

The pilot's lower armament control panel ([Fig. 11.6](#)) is used to control fire settings for rockets and GUV containers, set the active weapon system (rockets, 23 mm UPK containers, 12.7 mm PKT nose mounted machine gun, and to power up the gun camera system.

**N O T E .** To set GUV containers as the active weapon, the GUV payload profile must be set on the copilot's bombs control panel.

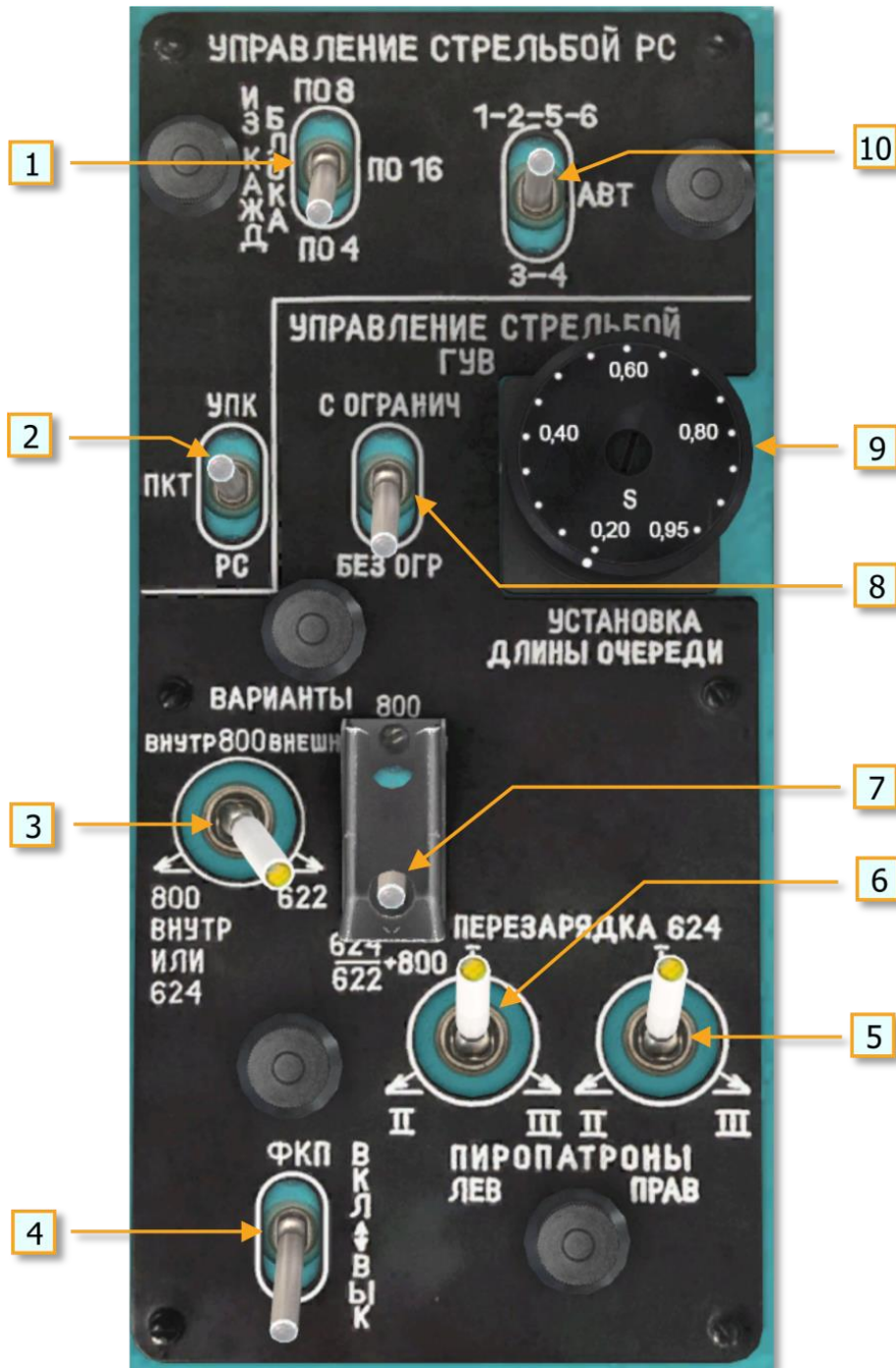

**Fig. 11.6. Pilot's lower weapons control panel.**

1. Rockets Quantity switch to control selection of 4, 8, or 16 rockets to be fired per pod
2. Weapon Selector switch: УПК (УПК) – ПКТ (ПКТ) – RKT (PC).
3. GUV (ГУВ) fire selector switch
4. Gun camera switch (not implemented)
5. Charging switch for reloading the right-side YakB-12.7 guns (three cartridges for guns I, II, III)
6. Charging switch for reloading the left-side YakB-12.7 guns (three cartridges for guns I, II, III)
7. GUV (ГУВ) payload selector switch
8. GUV (ГУВ) fire burst cutoff switch
9. GUV (ГУВ) burst length switch
10. Rocket Station Selector switch

- 1. Rockets Quantity switch: П08 – П016 – П04 (8 – 16 – 4).** Controls the number of rockets fired from each rocket launcher while the Weapons Fire switch is held down. For example if two pods are loaded, set the switch to "П04" to fire up to 8 rockets (4 per launcher).
- 2. Weapon Selector switch: УПК – ПКТ – РС (УПК – ПКТ – РКТ).** Used to select the weapon for fire when the Weapons Fire switch is pressed (except for GUV, which has a separate selector on the copilot's weapons configuration panel). УПК (UPK) – firing of UPK-23-250 gun pods. ПКТ (PKT) – firing of the nose-mounted PKT machine gun when in stow mode (not implemented). РС (RKT) – firing of unguided rockets from the B8V20-A launchers (pods).
- 3. GUV (ГУВ) Fire Selector switch: ВНУТР 800 ВНЕШ – 800 ВНУТР ИЛИ 624 – 622.** The ВНУТР 800 ВНЕШ position is used to select grenades for fire from stations 1 and 6. The 800 ВНУТР ИЛИ 624 position is used to select grenades or the YakB-12.7 machines gun for fire on stations 2 and 5. The 622 position is used to select the GShG-7.62 machines guns for fire on stations 2 and 5.

This switch is used in conjunction with the GUV Payload Selector switch. All possible switch combinations are reviewed below.

- 4. Gun Camera switch.** Enables the [gun camera](#), which records whenever the Weapons Fire switch is pressed on the Aircraft Commander's Cyclic control handle.
- 5. YakB-12.7 Charging switch (right).** Used to reload the YakB-12.7 gun pod machine guns in case of a jam. Must be placed to the "I" position prior to firing.
- 6. YakB-12.7 Charging switch (left).** Used to reload the YakB-12.7 gun pod machine guns in case of a jam. Must be placed to the "I" position prior to firing.
- 7. GUV Payload Selector switch: 800 – 624/622+800.** Set to 800 when only grenade launchers are loaded (stations 1, 2, 3, 4, 5, 6). Set to 624/622+800 when mixed payload is carried for correct fire selection: stations 1, 6 grenade launchers, 2, 5 machine gun pods.

This switch is operated in conjunction with the GUV Fire Selector switch. All possible switch combinations are reviewed below.

- 8. GUV Cutoff switch.** When set to OFF (down), the GUV containers will fire as long as the trigger switch is held down. When set to ON (up), the GUV containers will fire in burst lengths as set by the BURST knob.
- 9. GUV BURST knob.** Sets the burst length for GUV containers in seconds:
  - short and medium burst length is set by setting the knob to 0.25 and 0.6 seconds, respectively.
  - when employing the grenade launcher, setting the knob between 0.25 and 1.00 approximately equals the number of round expanded multiplied by a factor of 10.

- when employing the YakB 12.7 mm gun, setting the knob to 0.25 corresponds to approximately 15 – 18 rounds per burst; 0.6 to 40 – 42 rounds per burst
- when employing the 7.62 mm gun, setting the knob to 0.25 corresponds to approximately 20 – 25 rounds per burst; 0.6 to 50 – 60 rounds.

**10.** Rocket Station Select switch: 1-2-5-6 – AUTO – 3-4. Used to select rocket stations for fire.

When set to "1-2-5-6" rockets are fired in a sequence of:

- Rocket 1 from launchers 1 and 6
- 0.025 interval
- Rocket 1 from launcher 2 and 5

Rockets are fired from each launcher with an interval of 0.05 seconds.

When set to AUTO, rockets are first fired from launchers on stations 1, 2, 5, 6. Once these stations are expended, the system automatically switches to launchers on stations 3, 4.

#### 11.4. Bombs control panel

The bombs control panel is designed to indicate weapon stations loaded status, control tactical and emergency release of weapons, and arm the GUV firing circuits. The panel is installed on the canopy frame on the right side of the cockpit for use by the copilot ([Fig. 11.7](#)).



**Fig. 11.7. Copilot's payload configuration panel**

- |                               |   |
|-------------------------------|---|
| 1. Jettison ARMED switch      | 6. BOMBS MASTER switch (in EN-cockpit of the Game – MAIN BOMBS) |
| 2. Jettison ARMED light       | 7. Lamp test button   |
| 3. Jettison switch            | 8. Payload profile selector                                     |
| 4. Bombs circuit ON light     | 9. Payload profile guide  |
| 5. Stations loaded lights (6) | 10. ESBR heating switch (not implemented)                       |



1. **Jettison ARMED switch.** When set to ARMED (up), jettisoned bombs are armed for detonation upon impact.
2. **Jettison ARMED light.** Indicates bombs are armed to detonate upon impact if jettisoned. Illuminates if jettison ARMED switch is set to ARMED (up).
3. **Jettison switch.** Used to jettison bombs.
4. **BOMBS CIRCUIT ON light.** Indicates bomb release circuits are switched on. Illuminates if BOMBS MASTER switch is set to ON (up).
5. **Stations loaded lights.** Illuminate to indicate stations loaded with bombs when the BOMBS MASTER switch is to ON (up).
6. **BOMBS MASTER switch.** Energizes the bombs release circuits when set to ON (up).
7. **Lamp test button.** Tests the lights installed on the payload configuration panel.
8. **Payload profile selector.** Five-position selector is set to correspond to current payload and used to control the release/jettison of stores only from stations loaded with bombs (primarily intended to prevent accidental release/jettison of stores other than bombs).
  - **I. All rockets:** all bomb release circuits are energized, however no bombs (or any other stores) will actually release when any of the three bomb release triggers are pressed (two KSB-49 remote triggers or the OPB-1R optical bombing sight trigger).

N O T E . The release system does not actually "know" what types are stores are loaded on the stations, it is only supplied the position of the payload profile selector switch (8).

- **II. All bombs:** pressing any bomb release trigger will sequentially release all stores from all stations starting with station 6 with the first press of the release trigger.
- **III. 4 bombs + 2 rocket launchers:** pressing any bomb release trigger will sequentially release any stores from stations 6-1-5-2 starting with the first press of the release trigger.
- **IV. 2 heavy bombs + 2 rocket launchers:** pressing any bomb release trigger sequentially release any stores from stations 5-2 starting with the first press of the release trigger.
- **V. 2 heavy bombs + 2 standard bombs:** pressing any bomb release trigger will sequentially release any stores from stations 5-2-4-3 starting with the first press of the release trigger.

N O T E . The "-" (dash) mark on positions IV and V indicates that no release signal will be supplied to the corresponding station.



The "heavy bomb" symbol indicates a heavy or incendiary bomb, however this does not affect the jettison as any store type (including rocket launcher, UPK or GUV pod) will be successfully released from stations 5 and 2 in these payload profile selector positions.

**ГУВ (GUV).** Energizes the GUV firing circuits. In this position all other fire/release circuits are blocked and no other weapon system can be fired or released with the exception of an emergency release by the pilot's emergency jettison switch.

**9. Payload profile guide.** Payload profile index guide for profile setting.

**10. ESBR heating switch.** Set the electrical release control system heating on/off for operations in cold (negative) temperatures (not implemented).

### 11.5. ЭСБР-3П/А (ESBR-3P/A) Electrical release control box

The ESBR electrical release control box is located below the copilot's instrument panel. The ESBR controls sequential single or paired release of bombs and provides for station selection for release of any store.



**Fig. 11.8. ESBR control box**

- |                               |                       |
|-------------------------------|-----------------------|
| 1. Signal setting knob        | 21. ESBR power switch |
| 2. Signal setting index plate |                       |

**1. Signal setting knob.** Used to set single or pairs release mode or select the release number in the release sequence.

**2. Signal setting index plate.** The index plate consists of a series of numerical indexes that indicate either single ("I") or pairs ("II") release mode setting as well as Arabic numerals that indicate the current release number in the release sequence.

**3. ESBR power switch.** Connects the electrical release control system to the bomb release circuits.

When releasing bombs, all of the required circuit breakers must be switched ON, the BOMBS MASTER switch set ON (up), the desired payload profile set, the ESBR signal

setting knob (1) set to the desired position for release and the ESBR power switch (3) set to "BKЛ" (ON) (right).

When the signal setting knob is set to "\" or "0", no stores will be released. These positions are used to system ground tests.

**POSITION I:** In position "I", the ESBR commands the weapons control system for single bomb release in sequence from stations 6-1-5-2-4-3 (if payload profile "II" is set on the bombs control panel). However if desired, the ESBR can be used to manually select the desired station for release. For example, to select station 3 for release:

- turn off the ESBR by setting the ESBR power switch to "БыКЛ" (OFF) (left).
- set profile "II" on the bombs control panel (profile "V" will work as well, however this will alter the subsequent procedure)
- set the signal setting knob on the ESBR control box to "5"

When the ESBR is turned on with the signal setting knob set to "5", the next press of the bomb release trigger will release the store from the sixth station in the release sequence, i.e. station 3 given that it is preceded by stations 6, 1, 5, 2, 4 in the release sequence.

When the ESBR is turned on and profile "II" is set on the bombs control panel, rotating the signal setting knob past the "I" position will result in automatic release (without pressing the bomb release trigger) from the consecutive station(s) in the release sequence with each progressive setting of the knob.

**POSITION II:** In position "II", the ESBR commands the weapons control system for paired bombs release in sequence from stations 6+1, 5+2, 4+3 (if payload profile "II" is set on the bombs control panel). As with single release, the ESBR allows for manual station selection for paired release.

If profiles "IV" and "V" are set on the bombs control panel (and all relevant components required for stores release are enabled), a first press of the bombs release trigger will release stores from station 5 (or 5+2 if the ESBR is set to position "II"). I.e. in these payload profiles, release commands are not supplied to stations 6 and 1.

### ***11.6. PKV collimating Sight***

The PKV collimating sight ([Fig. 11.9](#)) is used to aid with visual target ranging and weapons aiming using target size methodology when employing the nose mounted PKT machine gun, external gun and cannon systems, rockets, and bombs.

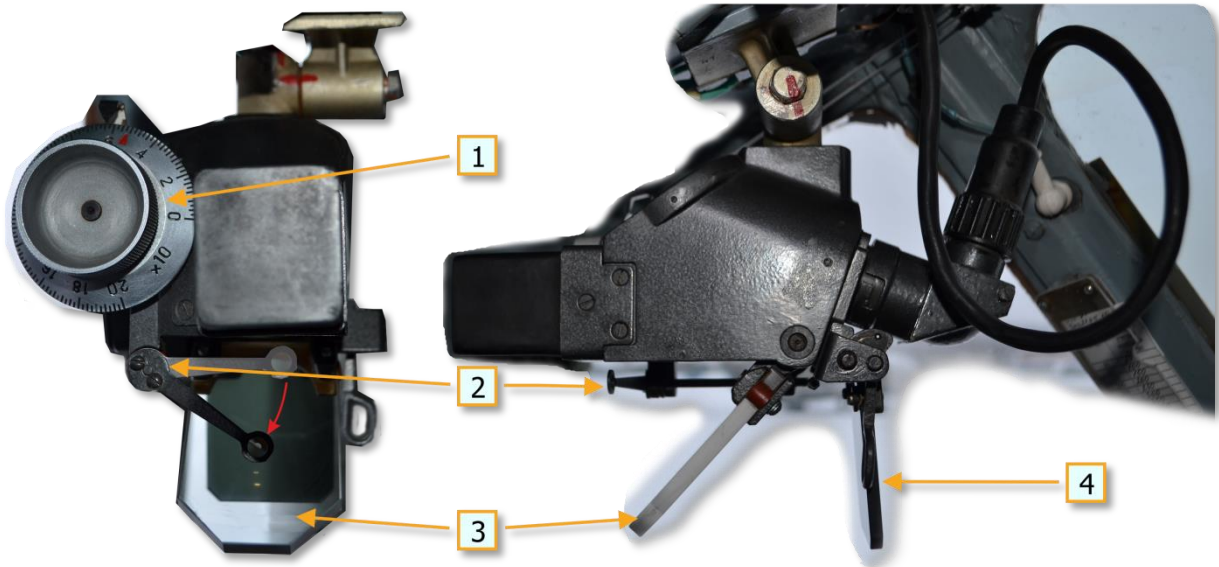

**Fig. 11.9. PKV collimating sight (front and side view)**

- |                                     |                                |
|-------------------------------------|--------------------------------|
| 1. Sight elevation knob             | 3. Reflector glass             |
| 2. Mechanical ring sight (stowable) | 4. Sun filter glass (stowable) |

The sight reticle [Fig. 11.10](#) is turned on by the “СИГНАЛИЗАЦИЯ” (INDICATION) circuit breaker.

In general, the target range can be defined by the formula

$$D_t = \frac{b_t}{2\text{tg}(0.5\psi_{t\text{-deg}})}$$

where:

$D_t$  = target range

$b_t$  = apparent target size (in meters)

$\text{tg}$  = tangent of angle math.function

$\psi_{t\text{-deg}}$  = target current angular size (in degree)

Target range is determined using the PKV reticle according to the following formula:

$$D_t = \frac{b_t}{\psi_{t\text{-mils}}} \times 1000$$

where:

$\psi_{t\text{-mils}}$  = target current angular size (in mils as viewed in the reticle)

For example, an object 100 meters in width will be 100 mils across in the reticle at a range of 1000 meters.

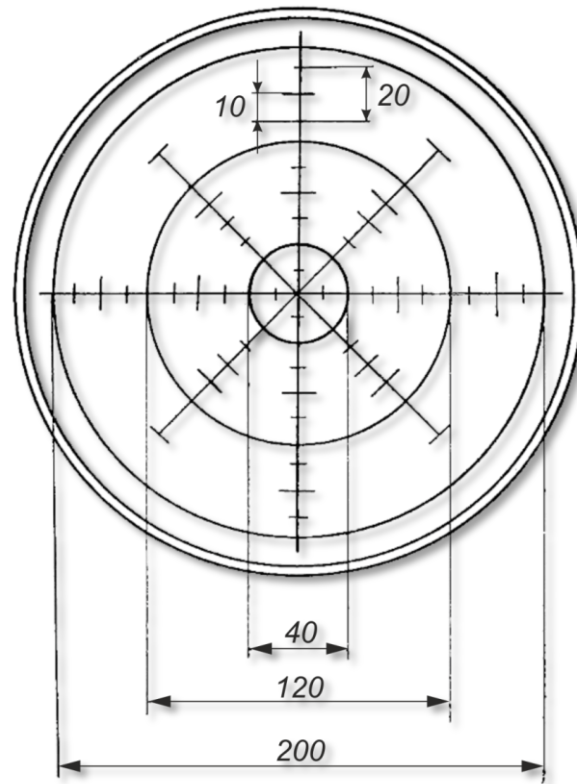

**Fig. 11.10. PKV reticle pattern with element sizes in mils**

The sight is installed on a bracket assembly on the left side of the cockpit ahead of the pilot's head position. To use the sight, the pilot must raise the seat by 15 – 20 cm.

PKV technical specifications: Table 11.1

**Table 11.1**

Reticle ring size:	Size (mils)
inner	20
middle	60
outer	100
Reticle graduation	10
Elevation knob numerical marking	each 20
Elevation knob graduation	2
Elevation knob large hash graduation	4
Elevation angle range	0 – 200 (0 – 11.5°)
PKV line of sight relative to helicopter water line (sight elevation set to 0)	57.5 (up)
Elevation knob red index corresponding to (mils)	52.4
Overall weight	1.8 kg

The elevation angle of the sight is set by manipulating the reflector glass using the elevation knob. Aim is accomplished by placing the sight reticle over the target.



The hash marks of the reticle allow for simple range estimation for targets of known (approximated) apparent size.

The sight is equipped with a stowable reserve mechanical ring sight in case the optical system is inoperable.

The "ПОДСВЕТ ПРИЦЕЛА" (SIGHT DIMMER) rheostat on the pilot's upper weapons control panel control reticle brightness. A stowable brightness filter glass is available for use in case of bright background (such as near direct sunlight).

The sight elevation angle is determined by projectile gravity fall, helicopter pitch angle, and particular weapon system's installed elevation angle relative to the helicopter water line (WL). As such, the sight elevation angle is the angle between the projectile throw elevation and the line of sight to the target ([Fig. 11.11](#)).

Sight elevation angles are recalculated for a variety of standard target ranges, helicopter airspeeds, flight profiles (level flight or dive) for each available weapon system. [Sight elevation charts](#) are provided in the Combat Employment chapter.

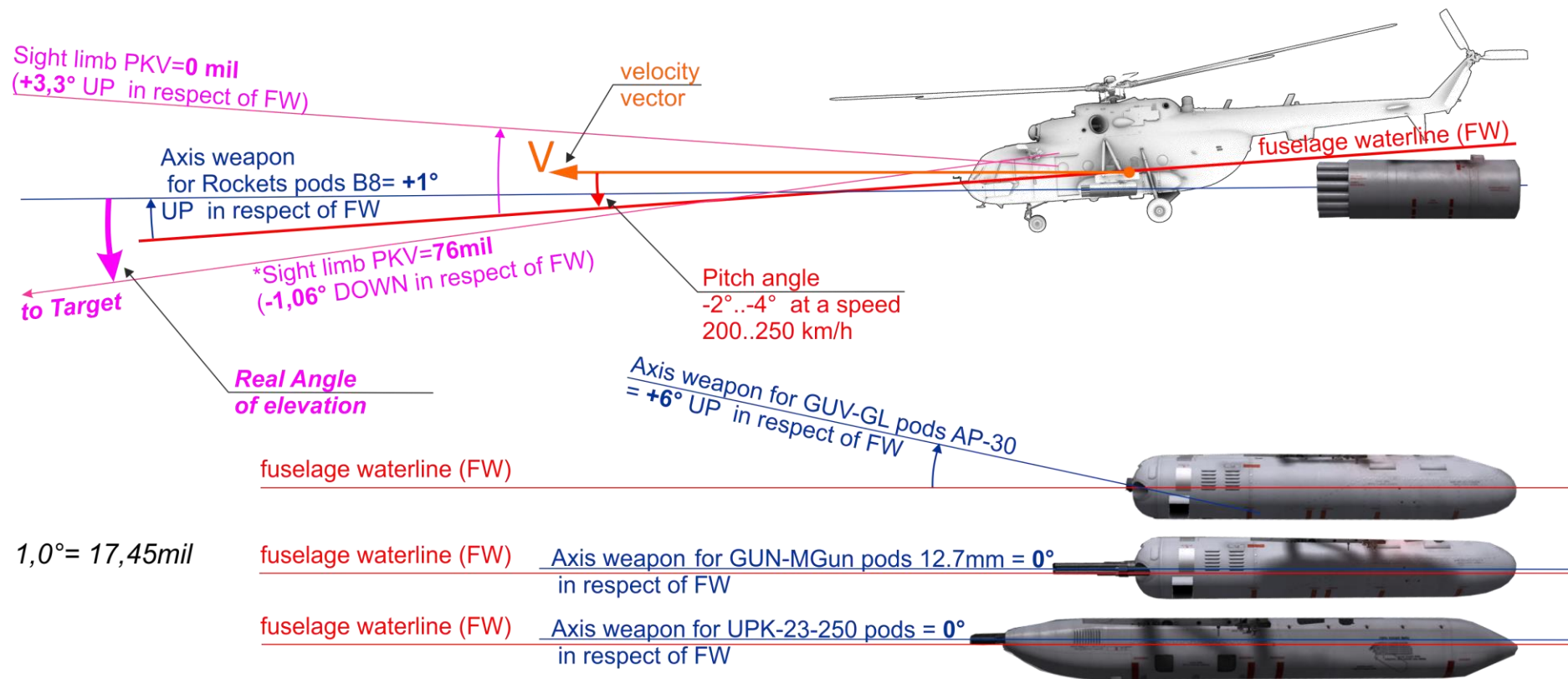

\*76mil - angle of elevation at limb PKV sight  
for air speed 200km/h and target distance 2000m

Fig. 11.11. Elevation angles relevant to weapons employment using the PKV collimating sight.

### 11.7. Weapons fire and bomb release switches

The WEAPONS FIRE switches installed on both cyclic control sticks **[Space]**



are used to employ all weapon systems, except release of bombs.

Bomb (or any other external store) release switches are available on the OPB-1r optical bombing sight (not implemented) and two KSB-49 remote bomb release triggers (one for the pilot and copilot located to the left and right of the respective instrument panels), [Fig. 11.1](#), 5, 10. Mouse can not be used for these buttons, only key commands are available **[B]**.

### 11.8. AKS-2 gun camera

The gun camera is installed on the left special hardpoint and can not be jettisoned.



It is used to photo-control how well pilot aims at a target.

The gun camera consists of device itself and the ФКП (GUN CAMERA) circuit breaker

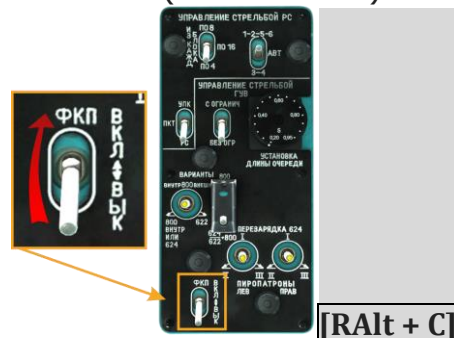

on the pilot's lower armament control panel

Main data of the AKS-2, [Table 11.2](#).

**Table 11.2**

Parameter	Value
shooting rate	24 or 48 fps
open sector of the obturator (device, preventing	120°

glares from the sun)	
frame size	16 x 22 MM
used film	35 mm (perforated)
shutter speed: at a frame rate of 24 fps at a frame rate of 48 fps	1/50 sec 1/100 sec
film length in the cartridge	60 m
duration of continuous shooting: at a frame rate of 24 fps at a frame rate of 48 fps	2 min.12 sec. 1 min. 6 sec.
focus distance	135 mm
max consumed current	12 A
power supply	27 V
size	474x139x210 mm
Weight	9,1 kg

In the game a frame rate of 24 fps is implemented.

NOTE: Optical axis of this device is parallel to the fuselage's centerline, therefore center position of the frame, relative to the target, taken by the gun camera, will be different from one, relative to the PKV center on a screenshot, if aiming angle on the PKV's sight elevation knob is different from 57.5 mils.

Photos, taken by the gun camera can be seen during the game or track replay. To do that, player must select one of the available GUN CAMERA MODE options in the

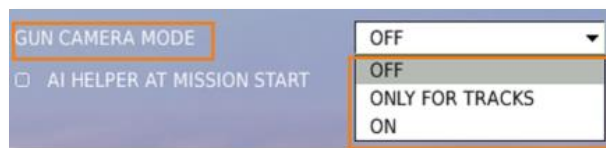

game settings:

- OFF – disabled;
- ONLY FOR TRACKS – photos will be shown during tracks only;
- ON – photos will be shown immediately, while shooting (can cause small fps drop).

All moments, whenever player pressed any of the combat triggers on cyclics, will be shown as “photos”, made by the AKS-2 gun camera:



**Fig. 11.12. Position and example of the photo, taken by the AKS-2 gun camera**

### **11.9. Weapon systems**

The Mi-8MTV2 weapons control system includes a number of sub-systems which make it possible to employ a variety of weapon systems in mixed payload configurations.

Mi-8MTV2 Payload configurations (profiles)

Available stores for each external weapon station are listed in Table 11.3.

**Table 11.3**

Available loads for weapons stations #1 – 6 for combat employment						In service with RF military
1	2	3	4	5	6	
–	B8	B8	B8	B8	–	yes
B8	B8	B8	B8	B8	B8	no <sup>1</sup>
–	UPK	B8	B8	UPK	–	yes
B8	UPK	B8	B8	UPK	B8	no
–	AB-250,100	B8	B8	AB-250,100	–	yes
AB-250,100	AB-250,100	B8	B8	AB-250,100	AB-250,100	no
AB-250,100	AB-250,100	AB-250,100	AB-250,100	AB-250,100	AB-250,100	yes
–	AB-500	AB-250,100	AB-250,100	A-500	–	yes
GUV (GD)	GUV (MG)	B8	B8	GUV (MG)	GUV (GD)	no
GUV (GD)	GUV (MG)	–	–	GUV (MG)	GUV (GD)	yes
GUV (GD)	GUV (GD)	–	–	GUV (GD)	GUV (GD)	yes
–	VSM	VSM	VSM	VSM	–	yes
–	UPK	VSM	VSM	UPK	–	yes
GUV (GD)	GUV (GD)	VSM	VSM	GUV (GD)	GUV (GD)	yes

<sup>1</sup> Not in service for administrative reasons, but technically supported by the Mi-8MTV2 weapons control system.



GUV (GD)	GUV (MG)	VSM	VSM	GUV (MG)	GUV (GD)	no
----------	----------	-----	-----	----------	----------	----

Chart legend:

- B8: B8V20-A rocket launcher with 20 80 mm S-8 unguided rockets;
- UPK: UPK-23-250 cannon pod system;
- AB-250, 100: 250 kg, 100 kg free-fall bomb;
- GUV (MG): GUV-8700 pod with 1 x 12.7 mm, 2 x 7.62 mm machine guns;
- GUV (GD): GUV-8700 pod with AG-17A automatic grenade launcher;
- VSM: mine container, part of the VSM-1 minelayin system (not implemented in simulation).

In any variants, the 12.7-mm KORD machine gun, installed in the cargo cabin doorway and the 7.62-mm PKT machine gun, installed in the hatch of the right cargo bay door, can be used.

### 11.9.1. Unguided rocket system

#### *Purpose*

The unguided rocket system is designed to be employed against column or area (group) targets consisting of unarmored or lightly armored ground units. The Mi-8MTV2 is armed with B8V20-A rocket launchers equipped with 20 S-8 80 mm rockets. Previous generation UB-32A-24 launchers equipped with S-5 57 mm rockets are no longer in service.

#### *Components*

Used with the B8V20-A launchers, the unguided rocket system includes:

- four 20-tube B8V20-A rocket launchers ([Fig.11.13](#)) (the weapons control system support up to 6 launchers)
- 80 S-8 unguided rockets of various modifications (S-8M, S-8AS, S-8B, S-8KO, S-8OF) (the weapons control system supports up to 120 S-8 type rockets)
- four ПУС-36-71 (PUS-36-71) fire control devices (FCU) integrated into the external weapon stations #1, 3, 4, 6
- control interfaces



**Fig.11.13. Loading of a B8V20-A rocket launcher on an Mi-8MTV5 helicopter.**

***Description***

The B8V20-A rocket launcher serves as a container/casing with 20 integrated launch tubes used to house and launch S-8 unguided rockets ([Fig.11.14](#)).



**Fig.11.14. B8V20-A launcher tubes as seen from the rear.**

The rocket launchers are attached to the weapon stations via suspension locks. The weight of an unloaded launcher is 100 kg. The weight of a loaded launcher is 332 – 405 kg depending on rocket modification.

The technical specifications of S-8 rocket modifications available in DCS: Mi-8MTV2 Magnificent Eight are provided below in Table 11.4.

**Table 11.4**

Rocket modification	S-8KOM <a href="#">Fig. 11.15</a>	S-8OM	S-8TsM <a href="#">Fig. 11.16</a>	S-8OFP2 <a href="#">Fig. 11.17</a>
Purpose	Destruction of lightly/medium armored units and troops	Illumination	Target designation	Destruction of troops (explosive and fragmentation effects) and lightly armored units
Diameter, mm	80	80	80	80
Length, mm	1570	1632	1632	1570
Launch mass, kg	11.3	12.1	11.1	16.7
Warhead/combustion section mass, kg	3.6	4.1	4.1	9.5
HE mass, kg	0.9	***	***	2.9
Warhead type	Dual-purpose (shaped charge/fragmentation)	Illumination flares, ignition 17 sec after launch, duration 40 sec	smoke	Explosive fragmentation, penetrating (delayed HE detonation), 1000 – 2000 fragments of 3 – 6 g
Peak velocity, m/s	Up to 650	Up to 545	670	Up to 450
Muzzle velocity, m/s	37 – 52	37 – 52	37 – 52	37 – 52
<a href="#">Targeting elevation angle</a> (mils) at 2000 m, level flight, V=200 kph	76	***	76	98

**Fig. 11.15. S-8KOM rocket**



**Fig. 11.16. S-8TsM rocket**

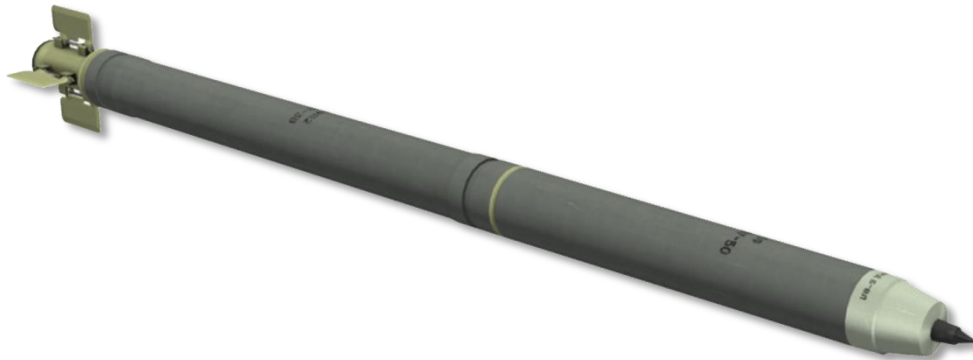

**Fig. 11.17. S-80FP2 rocket**

Ripple and salvo firing of rockets from multiple stations in various payload profiles is accomplished by use of ПУС-36-71 (PUS-36-71) fire control devices (FCU), which are integrated into the weapons stations. FCUs process and supply electric signals to the launch tubes of the B8V20-A launchers to command rocket launch. FCU-1 controls the launchers on stations #1-2; FCU-3 controls the launcher on station #3; FCU-4 controls the launcher on station #4; FCU-6 controls the launchers on stations #5-6.

Attached to the weapons stations, the launchers are elevated 1° up from the helicopter water line.

Rocket employment procedures are described in the [To deploy rockets from the B8V20 launcher](#) chapter.

## **11.9.2. UPK CANNON SYSTEM**

### ***Purpose***

The UPK podded cannon system is designed to be employed against individual and group unarmored or lightly armored ground targets within visual contact in day and night time conditions.

### ***Components***

The УКП-23-250 (UPK-23-250) cannon pods are equipped with GSh-23L 23 mm twin barrel cannon.

The podded cannon system includes the following components:

- two UPK-23-250 cannon pods equipped with the GSh-23L cannon ([Fig. 11.18](#))
- two weapons stations (#2, 5) supporting UPK-23-250 cannon pod loading
- control interfaces

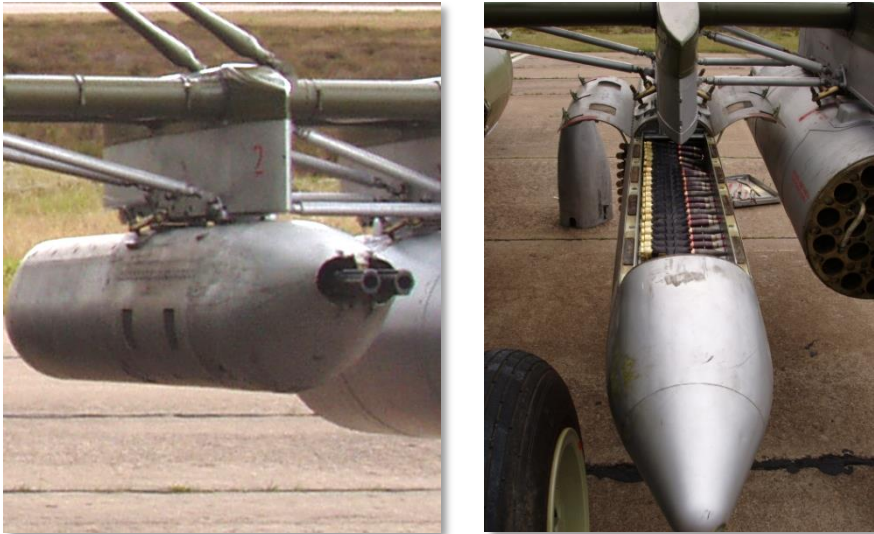

**Fig. 11.18. UPK-23-250**

### ***Description***



Each UPK pod is loaded with 250 rounds of 23 mm ammunition. The weight of a loaded UPK pod is 230 kg. The system includes an automatic burst cutoff of 0.16 seconds, during which 8-10 rounds are fired. The burst length cannot be adjusted.

The technical specifications of the GSh-23L cannon employed in the UPK-23-250 cannon system are provided below in Table 11.5.

**Table 11.5**

Specification	Value	
Caliber, m	23	
Dimensions, mm:		
length	1537	
width	165	
height	168	
Mass, kg	50±1.5	
Rate of fire, rounds/min	3000-3400	
Muzzle velocity, m/sec	715±15	
Recoil impulse, kgf	<2900	
Ammunition capacity	250	
Max burst length, rounds	10	
Thermal capacity, rounds	250	
Used cartridges:	HEFI-23-AM-GSH	API-T-23-AM-GSH



		
cartridge weight, g	338	340
shell weight, g	184	186
Shell properties	high explosive fragmentation incendiary	armor piercing incendiary - tracer

Aim is accomplished using the PKV collimating sight.

Attached to the weapons stations, the UPK pods are parallel to the helicopter water line.

Cannon employment procedures are described in the [To deploy UPK-23-250 23-mm gun container](#) chapter.

### 11.9.3. GUV universal gun or grenade launcher container systems

#### *Purpose*

GUV machine gun and grenade launcher podded systems are designed to be employed against individual and group unarmored or lightly armored ground targets within visual contact in day and night time conditions.

#### *Components*

The GUV gun pod systems include the following components:

- GUV-1 (GUV-8700) pod equipped with AG-17A (AP-30) 30 mm "Plamya-A" automatic grenade launcher (service index 9-A-800) ([Fig. 11.19](#)) or single YakB-12.7 (service index 9-A-624) 12.7 mm machine gun and twin GShG-7.62 (service index 9-A-622) 7.62 mm machine guns ([Fig. 11.20](#))
- four weapons stations (#1, 2, 5, 6) supporting GUV pod loading
- control interfaces



**Fig. 11.19. GUV-1 equipped with automatic grenade launcher**



**Fig. 11.20. GUV-1 equipped with machine guns**

### ***Description***

The grenade launcher variant of the GUV pod system is equipped with the AG-17A 30 mm automatic grenade launcher ("Plamya-A", AP-30, 9-A-800) ([Fig. 11.21](#)).

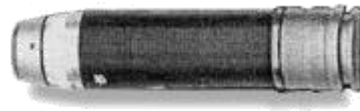

**Fig. 11.21. AG-17A ("Plamya-A") grenade launcher and VOG-17 grenade munition**

The grenade launcher pod is loaded with 300 grenades.

The technical specifications for the AG-17A (AP-30) automatic grenade launcher and its munition are provided below in Table 11.6

**Table 11.6**

Specifications	Value
Caliber, m	30
Munition	VOG-17 (VOG-17M)
Mass of grenade launcher, kg	21 – 22
Muzzle velocity, m/s	185
Muzzle energy, J	4791
Firing mode	Continuous (automatic)
Rate of fire	600/min
Practical range	1700
Direct fire range for 2 m target, m	200 – 250
Mass of munition, g	350 / 280 (36 g HE)
Self-destruct time, sec	25 – 27
Kill radius , m	6 – 7

The machine gun variant of the GUV pod system is equipped with a single YakB-12.7 (9-A-624) 12.7 mm machine gun ([Fig. 11.22](#)) and two GShG-7.62 (9-A-622) 7.62 mm machine guns ([Fig. 11.23](#)).



**Fig. 11.22. YakB-12.7 12.7 mm 4-barrel Gatling gun**





**Fig. 11.23. GShG-7.62 7.62 mm 4-barrel Gatling gun**

The gun variant of the GUV pod is loaded with 750 rounds of 12.7 mm ammunition and 3400 rounds of 7.62 mm ammunition.

The technical specifications for the machine guns equipped on the GUV-1 pod system are provided below in Table 11.7.

**Table 11.7**

Specifications	Value			
Caliber, mm	12.7		7.62	
Dimensions, mm:				
length	1345		800	
width	145			
height	190			
Mass, kg	45		19	
Rate of fire, rounds/min	4000-4500		6000	
Muzzle velocity, m/s	810		850	
Recoil impulse, kgf	1400			
Ammunition capacity, rounds	750		1800	
Max burst length, rounds	400		1000	
Operational life, rounds	8000			
Used cartridges (rounds)	12.7 API-T BZT-44	12.7 API B-32	7.62 AP-T 	7.62 API B-32 

				
Cartridge weight, g	128 (BZT-44) 133,5 (B-32)		21,6 (AP-T) 22,9 (B-32)	
Bullet weight, g	44 (BZT-44) 48,2 (B-32)		9,2 (AP) 10,4 (B-32)	
Bullet properties	BZT-44 (API-T) – armor piercing incendiary tracer B-32 (API) armor piercing incendiary		AP-T - armor piercing tracer B-32 (API) armor piercing incendiary	

The weight of a loaded machine gun variant of the pod does not exceed 452 kg. The weight of a loaded grenade launcher variant does not exceed 274 kg.

In the grenade launcher pod is loaded on weapons stations #1, 2, 5, 6 (1, 6 if only two pods loaded). The machine gun pod is loaded only on stations #2, 5.

The machine gun pods are attached to the weapons station parallel to the helicopter water line. The grenade launcher elevation is +6° from the water line.

The weapons control system supports simultaneous loading of grenade launcher and machine gun pod systems. In this case, grenade launcher pods are loaded on stations #1, 6 while machine gun pods are loaded on stations #2, 5. Employment of the different pod systems in the same payload configuration must be separate (i.e. cannot fire grenade launcher and machine gun pods simultaneously).

### **Limitations**

The YakB-12.7-mm gun requires cooling time after expanding 400 rounds of ammunition as follows:

- 25 min if OAT is greater than +10°C



- 15 min if OAT is -10°C to +10°C
- 5 min if OAT is below -10°C

The GShG-7.62 gun requires a 25 minute cooling cycle after expanding 1000 rounds of ammunition if OAT is under 20°C. If OAT exceeds 20°C, fire past 1000 rounds is **prohibited**.

GUV launcher employment procedures are described in the [To deploy the 12.7-mm \(7.62-mm\) machine guns and 30-mm grenade launchers from GUV-1](#) chapter.

#### 11.9.4. Weapon, installed in the cargo cabin

##### *Purpose*

Weapon, installed in the cargo cabin is fired by the airborne troops at aerial and ground targets during the flight and on the ground, at any time of the day when a target is visually observed.

Note. The weapon option, which is described here and used in the game is not the only one, used in real life.

The following weapon, installed in the helicopter, can be fired simultaneously or separately:

- the 12.7-mm KORD machine gun, installed in the left doorway;
- the 7.62-mm PKT machine gun, installed in the hatch of the right cargo bay door.

##### *Components*

The firearms, available for the DCS: Mi-8MTV2 include:

- one 12.7-mm KORD machine gun, in the left doorway of the cargo cabin, mounted on the floor (rack with hinges allows to rotate machine gun in horizontal and vertical surfaces within a certain range)



- one tail 7.62-mm PKT tank machine gun with a bag affixed to the gun to capture ejected casings, installed in the hatch of the right cargo bay door with help of special hindges.



### General description

Main characteristics of both guns are presented in the Table 11.8

**Table 11.8**

№	Technical characteristic	KORD-12.7 (door)		PKT-7.62 (tail)	
1	Caliber, mm	12,7		7.62	
2	Shooting rate, rounds per minute	around 600		700	
3	Used cartridges:	12.7 BZT-44	12,7 B-32	7,62 BT	7,62 B-32
					
4	Cartridge weight, g	128 (BZT-44) 133,5 (B-32)		21,6 (BT) 22,9 (B-32)	
5	Bullet weight, g	44 (BZT-44) 48,2 (B-32)		9,2 (BT) 10,4 (B-32)	
6	Свойства пули	BZT-44 (API-T) – armor		BT (AP-T) – armor	

		piercing incendiary -tracer B-32 (API) – armor piercing incendiary	piercing - tracer Б-32 (API) –armor piercing incendiary
7	Initial bullet velocity, m/s	860..820	855..800
8	Max aiming distance, ь	up to 2000	up to 1000
9	Barrel weight, kg	9,25	3,23
10	Ammo belt weight, kg	7,7 (50 rounds)	9,4 (250 rounds)
11	Machine gun deflection angles, relative to attachment point:		
	horizontally (from the surface, which is perpendicular to the fuselage centerline and goes through the attachment point)	-30° (to the left)..+45° (to the right)	ftom +10° (the most left position)..+75° (the most right position)
	vertically (from the surface which is parallel to the helicopter’s floor and goes through the attachment point)	+10° (up)...- 45° (down)	+10° (up)...- 45° (down)
12	Accuracy (R50) at a distance of 100 m, mm	not more than 300	
13	Service life, rounds	10000	
14	Armor piercing capability, mm	up to 20 at 100 m	up tp 5 at 500 m
15	Ammunition load on the helicopter	12 ammo belts (boxes) with 50 rounds each	3 belts (boxes) with 250 rounds each

Machine guns’ deflection angles in the horizontal and vertical surfaces, [Fig. 11.24](#):

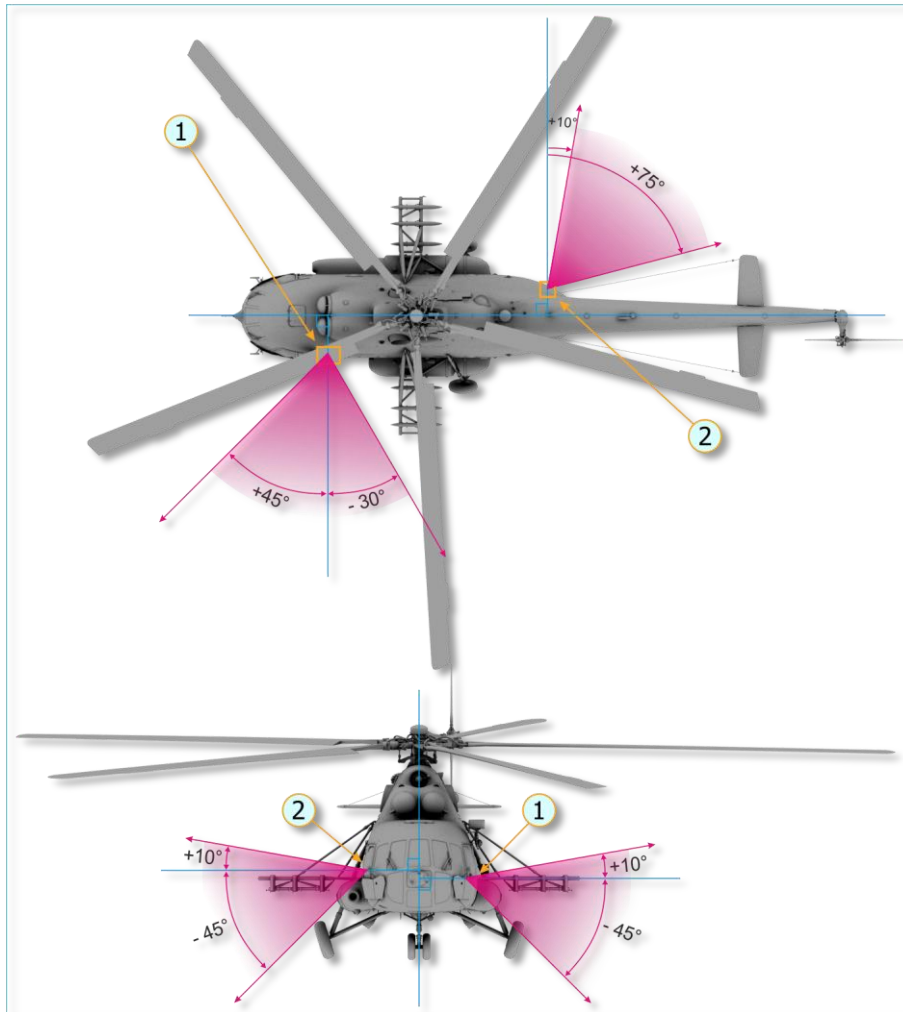

**Fig. 11.24. Deflection angles of the KORD and PKT machine guns in the horizontal and vertical surfaces**

1. 12.7-mm KORD machine gun

2. 7.62-mm PKT machine gun

The machine guns are controlled by the AI-gunners, the player can set the ROE behavior for them. Besides that, the 12.7-mm KORD machine gun can be controlled by the player, see [here](#).

#### ***Implementation of the 12.7-mm KORD machine gun in the game***

In the game, this machine gun is installed on the floor in the helicopter's cargo cabin, [Fig. 11.25](#):

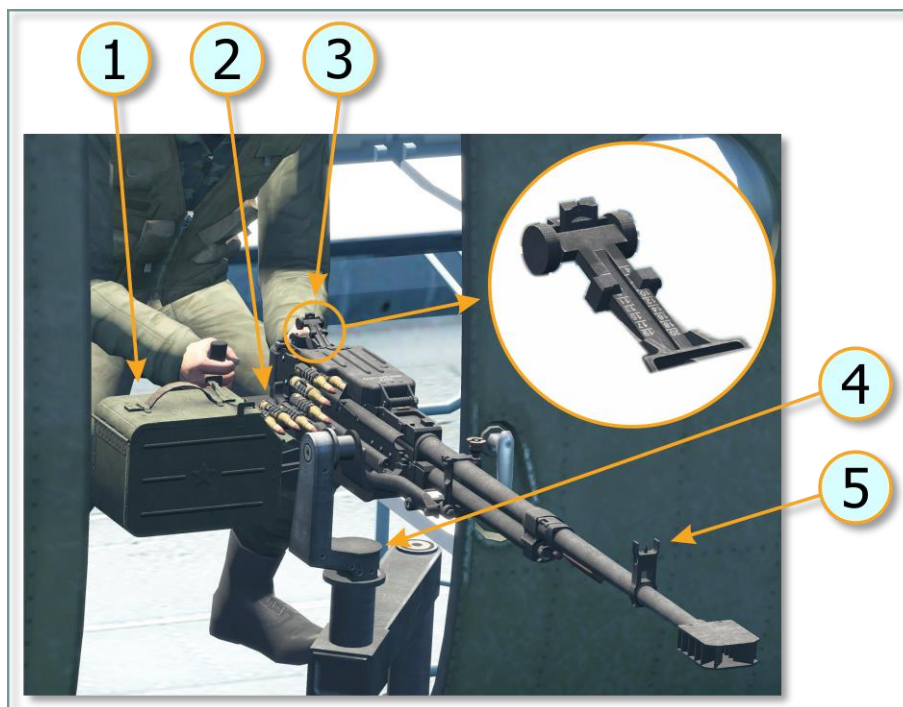

**Fig. 11.25. Implementation of the 12.7-mm KORD machine gun in the game, main elements**

- |   |                     |
|---|---------------------|
| 1. Ammo box 12.7-мм (50 rounds)                           | 4. Mounting rack    |
| 2. Ammo belt with cartridges                              | 5. Front sight post |
| 3. Tangent rear sight with calibrated markings for ranges |                     |

Reload of a new ammo belt takes around 5-7 seconds.

Machine guns deployment, see [here](#).

### 11.9.5. Bomb delivery system

#### *Purpose*

The bomb delivery system is designed to be employed against ground targets using aimed bombing with 100, 250, or 500 kg free-fall bombs released from level flight within visual target contact in day and night time conditions.

#### *Components*

The bomb delivery system includes the following components:

- six weapons stations equipped with БДЗ-55ТН (BDZ-55TN) suspension locks
- ОПБ-1Р (OPB-1R) optical bombing sight with "ЛЕВО — ПРАВО" (LEFT-RIGHT) cueing signal lighting
- ЭСБР-3П/А (ESBR-3P/A) electrical release control system
- system controls



### **Description**

At altitudes between 100 – 4000 m, bomb sighting is performed by the copilot using the OPB-1R optical bombing sight. At altitudes below 100 m, bomb sighting is performed by the pilot using the PKV collimating sight.

The right KSB-49 remote bomb release trigger and the BOMB RELEASE switch of the OPB-1R optical bombing sight are used by the copilot for tactical (combat) release of bombs. The release switches are connected to the release circuits via the BOMBS MASTER switch.

The left KSB-49 remote bomb release trigger is used by the pilot for tactical (combat) release of bombs. The switch is connected to the release circuits via the BOMBS MASTER switch.

The bomb delivery system provides both the pilot and copilot the ability to release bombs tactically or jettison in case of emergency. Tactical release is always performed for bomb detonation and in a particular release sequence based on the position of the PAYLOAD PROFILE selector on the bombs control panel and the signal setting switch of the ESBR electrical release control box.

Bombs jettison can be performed either for detonation or not depending on the position of the ARM switches on the corresponding weapon control panels.

When jettisoned by the pilot, all bombs, rocket launchers and containers are released from the weapons stations. When jettisoned by the copilot, all bombs are released only when the PAYLOAD PROFILE selector is set to position II or V.

When the PAYLOAD PROFILE selector is set to position III or IV, rocket launchers cannot be released from the weapons stations by the copilot via the bombs control panel. Rocket launchers can be released by the pilot using the EMER JETTISON switch on the pilot's upper weapons control panel. If release by the copilot is required, the PAYLOAD PROFILE selector must be set to position II or V (to "fool" the weapons control system that all weapons stations are loaded with bombs).

#### **Free-falling bombs**

The DCS Mi-8MTV2 is armed with 100 kg bombs (FAB-100, SAB-100), 250 kg bombs (FAB-250) ([Fig. 11.26](#)), and 500 kg bombs (FAB-500M62). Incendiary bombs are not implemented.



**Fig. 11.26. FAB-250 250 kg free-fall bomb**

FAB – high explosive warhead. Designed to be employed against personnel, vehicles and other types of ground targets.

SAB – illumination bombs. Designed to illuminate the battle area in low light conditions. Can and have previously (Tajikistan) been used as a preventative<sup>1</sup> countermeasure against MANPAD and other infrared-guided SHORAD systems.

In DCS, bombs are modeled with impact fuses, making their delivery at low altitudes dangerous. Delayed fuse modeling is planned.

Bomb employment procedures are described in the [To deploy bomb armament](#) chapter.

---

<sup>1</sup> When operating in canyons/valleys, a covering flight releases 4 – 6 SAB illumination bombs before the primary flight entered below, forcing any potential air defense assets on the ground to aim in the direction of the illumination flares as they attempted to target the primary flight helicopters.



**12**

***WEAPONS  
EMPLOYMENT***

## 12. WEAPONS EMPLOYMENT

### 12.1. Preparing the module for combat deployment

#### 12.1.1. Selecting helicopter's payload in the mission editor

If player creates a mission with combat deployment on his own, then, after placing the helicopter on the map in the mission editor, it is necessary to select required payload. This is done using the "PAYLOAD" tab in the mission editor

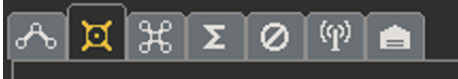

Weapon that can be installed on the hardpoints 1-6, PKT and KORD machine guns, which can be installed in the cargo cabin, are schematically shown on the Fig. 12.1

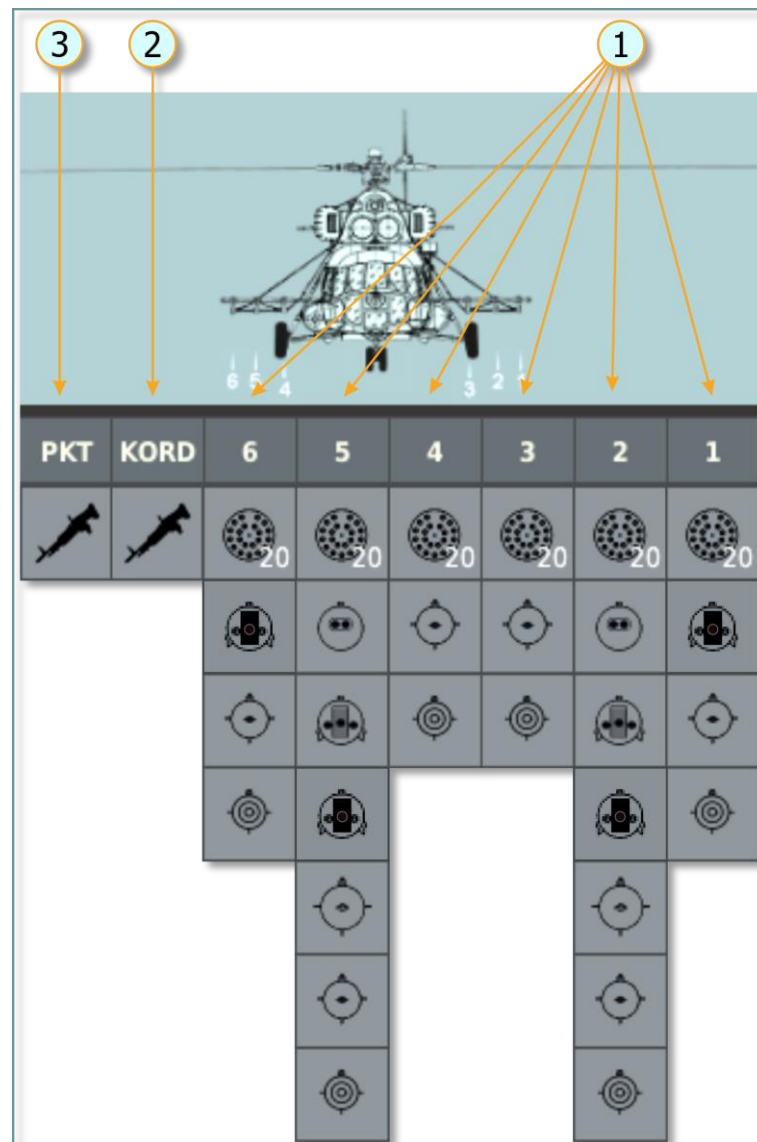

**Fig. 12.1. Payload available for the MI-8MTV2 in the mission editor**







1. Possible weapon that can be installed on the hardpoints from 1 to 6.

2. Installs the 12.7-mm KORD machine gun in the cargo cabin doorway

3. Installs the 7.62-mm PKT in the hatch of the right cargo bay door

The following weapon is schematically shown (Table 12.1):

**Table 12.1**

Nº	Icon in the ME	Description
1		B8V20 rocket launcher
2		the UPK-23 gun container with a double-barrel 23-mm gun
3		GUV-1 universal machine gun and grenade launcher container with one 12.7-mm and two 7.62-mm machine guns
4		GUV-1 universal machine gun and grenade launcher container with one 30-mm grenade launcher
5		500-kg bomb
6		250-kg bomb
7		100-kg bomb

More information about mission development can be found in the DCSW\Doc\DCS User Manual EN.pdf

### **12.1.2. Snapviews creation for simplifying interaction with cockpit objects while playing mission**

Described in the chapter [14.4.2](#).

## ***12.2. The peculiarity of piloting with external payloads***

After installation of weapon on external hardpoints, helicopter's mass center moves a bit forward. It changes cyclic deflections and pitch angle at all flight modes. During level flight, balancing position of the cyclic is about 1/5..1/6 of the full travel range less than in flights without payload on external hardpoints. During rockets launching (bursts with 8-16 rockets per launcher), ejects from rocket's engines impact on the launcher, which accompanied by a small change in pitch moment (dive moment).

## ***12.3. Weapon's subsystem enabling procedures***

In the [12.3](#) chapter, procedures for each weapon type, starting from enabling circuit breakers and to pressing combat trigger, are described. Enabling the equipment during combat deployment is considered in the [12.4](#).



### 12.3.1. To deploy rockets from the B8V20 launcher

Once helicopter has been started and there is a voltage in the rectifier buses, is necessary:

#### [Rockets aiming angles table](#)

<p><b>1. Enable circuit breakers</b> on the left circuit breaker console (only those needed for shooting are shown)</p>	
<p><b>2. Enable MASTER ARM SWITCHES</b> <b>[Lalt + S]</b>;</p>	
<p><b>3. On the pilot's upper armament control panel:</b></p>	

<ul style="list-style-type: none"> <li>a) by pressing the "ПРОВЕРКА ЛАМП" (CHECK LAMPS) button (1) check that all lamps on the panel are on (2)</li> </ul>	
<ul style="list-style-type: none"> <li>b) enable the "ГЛАВНЫЙ ВЫКЛЮЧАТЕЛЬ РС, ГУВ" (a) (RKT-GUN MASTER switch) and check that the "БД (HARDPOINTS) 3, 4 (1, 2, 5, 6) ЗАГРУЖЕН (LOADED)" (b), "СЕТЬ РС ВКЛ." (ROCKETS LAUNCHING CIRCUIT) (c), "ПУС (LAUNCHERS) 3, 4 (1, 6) ВЗВЕДЁН (ARMED)" (d) lights are on, depending on payload profile</li> </ul>	
<ul style="list-style-type: none"> <li>c) if the "ПУС .. ВЗВЕДЕН" (FCU LAUNCHER ARMED) light is off, by pressing "ВЗВЕДЕНИЕ ПУС" (ARM FCU LAUNCHERS) button, set the launchers to their initial position;</li> </ul>	
<p><b>4. On the pilot's lower armament control panel,</b> on the УПРАВЛЕНИЕ СТРЕЛЬБОЙ РС (ROCKETS LAUNCHING CONTROL) panel:</p>	

<ul style="list-style-type: none"> <li>a) by using the "ИЗ КАЖДОГО БЛОКА – по 8 – по 16 – по 4" (FROM EACH POD burst of 8 -16 -4 rockets) rockets quantity selector switch, set the required number of rockets to be fired from each launcher ("по 8" – each long press of the combat trigger will fire 8 rockets from each launcher, "по 16" and "по 4" – 16 and 4 rockets correspondingly). By default, this switch is set to the "по 4" (down) position</li> </ul>	
<ul style="list-style-type: none"> <li>b) by the "1-2-5-6 – АВТ (AUTO) – 3-4" switch connect the required launchers: in the АВТ (AUTO) position – rockets will be fired from launchers on hardpoints 1, 2, 5 and 6 (if they are mounted there), and when they are empty, system will automatically switch to firing from launchers on hardpoints 3 and 4. In any other position, only launchers on corresponding hardpoints will be fired. By default, this switch is set to АВТ (AUTO) (middle position)</li> </ul>	
<ul style="list-style-type: none"> <li>c) by the "УПК-ПКТ-РС" (УПК-ПКТ-ROCKETS) switch, connect rockets launching circuits to the combat button by setting it to the "РС" (ROCKETS) (down) position; by default this switch is set to the "РС" (ROCKETS) position</li> </ul>	



5\*. Enable the gun camera (optionally). To watch photos, taken by the gun camera, player must enable gun camera functionality in the [special tab of the module settings](#)

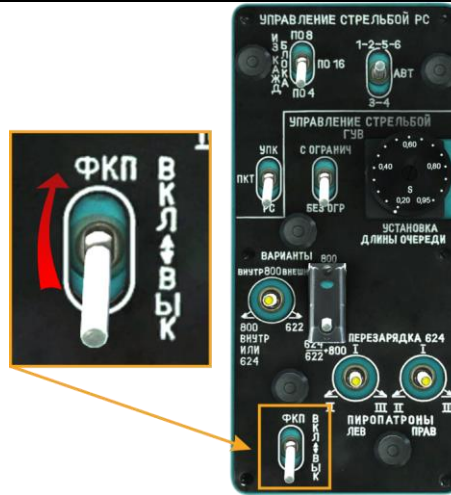

6\*. On the co-pilot's bomb armament panel set the "ВАРИАНТЫ ПОДВЕСКИ" (PAYLOAD PROFILE) selector to the position, corresponding to current payload: shooting is possible from only



those hardpoints, which have the symbol in the payload profile (for B8V20 it is I (all launchers), III (launchers on 3<sup>rd</sup> and 4<sup>th</sup> hardpoints), IV (launchers on 3<sup>rd</sup> and 4<sup>th</sup> hardpoints))



7. Press the PC (ROCKETS) button on the cyclics under the safety cover – rockets will be fired [Space].



### 12.3.2. To deploy UPK-23-250 23-mm gun container

Once helicopter has been started and there is a voltage in the rectifier buses, is necessary:

**1. Enable circuit breakers** on the left circuit breaker console (only those needed for shooting are shown)



**2. Enable MASTER ARM SWITCHES**  
**[Lalt + S]**



**3. On the pilot's upper armament control panel:**

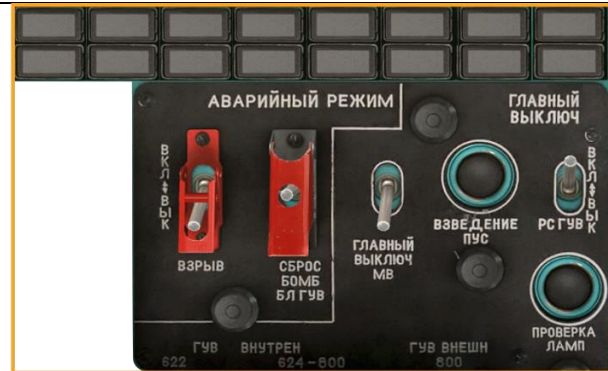



<ul style="list-style-type: none"> <li>a)* by pressing the "ПРОВЕРКА ЛАМП" (CHECK LAMPS) button (1) check that all lamps on the panel are on (2)</li> </ul>	
<ul style="list-style-type: none"> <li>b) enable the "ГЛАВНЫЙ ВЫКЛЮЧАТЕЛЬ РС, ГУВ" (a) (ROCKETS GUV MASTER SWITCH) and check that the "БД (HARDPOINTS) 2, 5 ЗАГРУЖЕН (LOADED)" (b), "СЕТЬ РС ВКЛ." (ROCKETS LAUNCHING CIRCUIT) (c), lights are on</li> </ul>	
<p><b>4. On the pilot's lower armament control panel, on the УПРАВЛЕНИЕ СТРЕЛЬБОЙ РС (ROCKETS LAUNCHING CONTROL) panel, by the "УПК-ПКТ-РС" (UPK-PKT-ROCKETS) switch, connect UPK-23-250 firing circuits to the combat button by setting it to the "УПК" (UPK) (up) position</b></p>	

<p><b>5*. Enable the gun camera</b> (optionally). To watch photos, taken by the gun camera, player must enable the gun camera functionality in the <a href="#">special tab of the module settings</a>.</p>	
<p><b>6. Press the PC (ROCKETS) button [Space] on the cyclics, under the safety cover (can be opened using mouse) – bursts of 8-10 rounds from each gun will be fired.</b></p>	

### 12.3.3. To deploy the 12.7-mm (7.62-mm) machine guns and 30-mm grenade launchers from GUV-1

Once helicopter has been started and there is a voltage in the rectifier buses, is necessary:

**1. Enable circuit breakers** on the left circuit breaker console (only those needed for shooting are shown with solid line, those needed for emergency jettison are shown with dashed line, see [12.5.2](#))



**2. Enable MASTER ARM SWITCHES**  
 [Lalt + S];

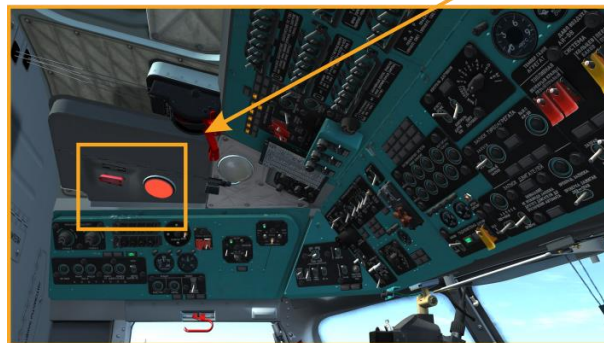

**3. On the co-pilot's bomb armament panel set the "ВАРИАНТЫ ПОДВЕСКИ" (PAYLOAD PROFILE) to the "ГУВ" GUV position, using or .**  
 In this position firing and signalization circuits of the GUV containers are connected (see 4 b), while rockets', UPK's and bombs' circuits are disconnected.



**4. On the pilot's upper armament control panel:**

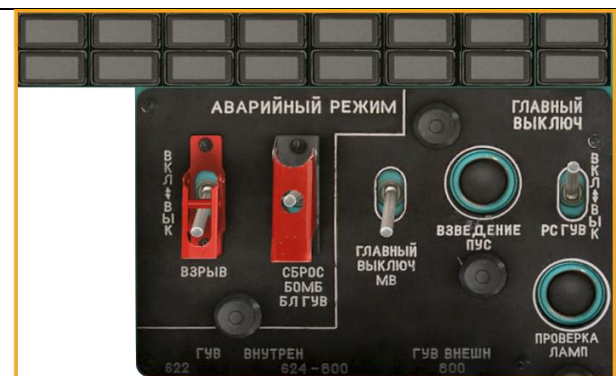

- a)\* by pressing the "ПРОВЕРКА ЛАМП" (CHECK LAMPS) button (1) check that all lamps on the panel are on (2)

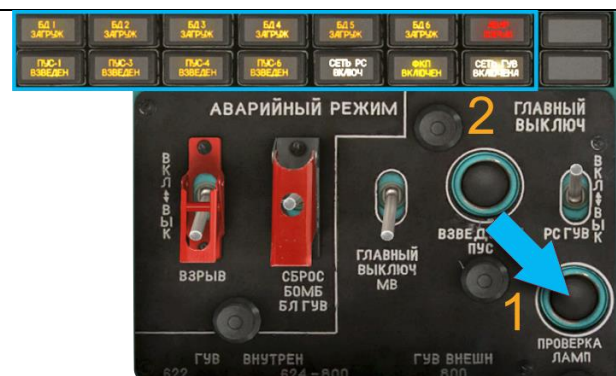



<ul style="list-style-type: none"> <li>b) enable the "ГЛАВНЫЙ ВЫКЛЮЧАТЕЛЬ РС, ГУВ" <b>(a)</b> (ROCKETS GUV MASTER SWITCH) and check that the "БД (HARDPOINTS) 1, 2, 5, 6 ЗАГРУЖЕН (LOADED)" <b>(b)</b> (depending on payload), "СЕТЬ ГУВ ВКЛ." (GUV FIRING CIRCUIT) <b>(c)</b> lights are on</li> </ul>	
<p><b>4. On the pilot's lower armament control panel, on the УПРАВЛЕНИЕ СТРЕЛЬБОЙ ГУВ (GUV FIRING CONTROL) panel:</b></p>	
<ul style="list-style-type: none"> <li>a) set the "УСТАНОВКА ДЛИНЫ ОЧЕРЕДИ С ОГРАНИЧ – БЕЗ ОГР" (BURST LENGTH LIMITATION – NO LIMITATIONS) to the "БЕЗ ОГР" (NO LIMITATIONS) (down) <b>[Lalt + R]</b>, in this case burst length will depend only on how long the combat button is being kept pressed</li> </ul>	



<ul style="list-style-type: none"> <li>b) set the "<b>ВАРИАНТЫ (VARIANTS): 800 – 624/622+800</b>" switch to the "800" (up) position <b>[Ralt + RCtrl + P]</b>, if there are GUV grenade launchers (AP-30) on hardpoints 1,2,5,6; open the safety cover <b>[Rshift + O]</b></li> </ul>	
<ul style="list-style-type: none"> <li>c) set the "<b>ВАРИАНТЫ (VARIANTS): 800 – 624/622+800</b>" switch to the "624/622+800" (down) position <b>[Ralt + RCtrl + O]</b>, if there are GUV grenade launchers (AP-30) on hardpoints 1,6 (or nothing) and machine gun GUVs with 12.7-mm and 7.63-mm machine guns on hardpoints 2,5 ; "624/622+800" is a default position</li> </ul>	
<ul style="list-style-type: none"> <li>d) set the 4-position switch <b>ВАРИАНТЫ ВНУТР 800 ВНЕШ – 800 ВНУТР ИЛИ 624 – 622</b> (GUV fire selector switch) <b>[Ralt + RCtrl + I]</b> or <b>[Ralt + RCtrl + J]</b> into:</li> </ul>	
<p>– "ВНУТР 800 ВНЕШ" (INTERNAL 800 EXTERNAL) to fire AP-30 on hardpoints 1,6,2,5 simultaneously or 1,6 (if there are no AP-30 on hardpoints 2 and 5)</p>	
<p>– "800 ВНУТР ИЛИ 624" (800 INTERNAL or 624)– to fire 12.7-mm machine guns on hardpoints 2 and 5;</p>	
<p>– "622" – to fire 7.62-mm machine guns on hardpoints 2 and 5;</p>	

<p>6*. Enable the gun camera (optionally). To watch photos, taken by the gun camera, player must enable the gun camera functionality in the <a href="#">special tab of the module settings</a></p>	
<p>7*. Reload 12.7-mm guns in case of misfires (misfires are not modelled in the game)</p>	
<p><b>8. Press the PC (ROCKETS) button [Space] on the cyclics, under the safety cover, to fire the GUVs.</b></p>	

#### 12.3.4. To deploy machine guns in cargo cabin

No need to enable anything from the cockpit.

#### 12.3.5. To deploy bomb armament

Once helicopter has been started and there is a voltage in the rectifier buses, is necessary:

**1. Enable circuit breakers** on the left circuit breaker console (only those needed for bombing and for emergency jettison, see [12.5.2](#))



**2. Enable MASTER ARM SWITCHES** **[Lalt + S]**;

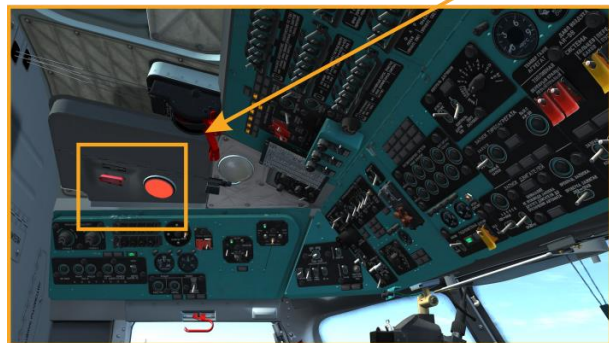

### 3. On the pilot's upper armament control panel:

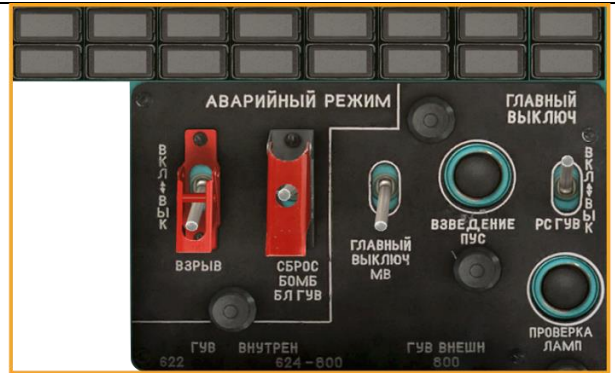

- a)\* by pressing the "ПРОВЕРКА ЛАМП" (CHECK LAMPS) button (1) check that all lamps on the panel are on (2)



- b) enable the "ГЛАВНЫЙ ВЫКЛЮЧАТЕЛЬ РС, ГУВ" (a) (ROCKETS GUV MASTER SWITCH) and check that the "БД (HARDPOINTS) 1- 6 ЗАГРУЖЕН (LOADED)" (b) (depending on payload) lights are on

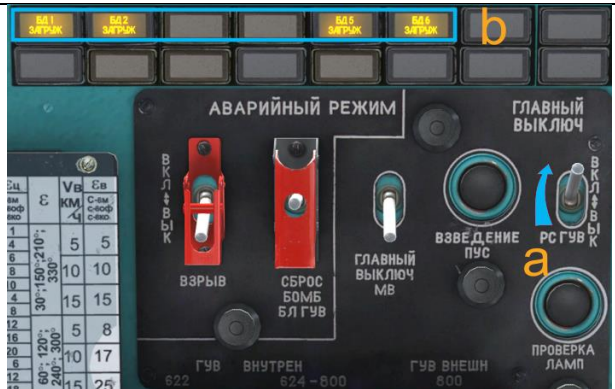







#### 4. On the **co-pilot's weapon control panel:**



- a) set the "ВАРИАНТЫ ПОДВЕСКИ" (PAYLOAD PROFILE) to the position, corresponding to the current payload profile with



bombs (those, where the ,  symbols are present)

using  or , which, depending on profile, connects to tactical and emergency release circuits only those hardpoints, on which bombs are present



- b) enable the ГЛАВНЫЙ ВЫКЛЮЧ. БВ (MASTER ARM BOMBS) **[RCtrl + P]** after that corresponding light panels (from two to six БД1 ЗАГРУЖ – БД6 ЗАГРУЖ. (HARDPOINT 1 LOADED – HARDPOINT 6 LOADED) yellow panels ) go on, indicating that bombs are present on hardpoints.





5. On the **ESBR-3P/A** electrical release box panel:



- a) set the impulse generating knob to one of the two positions: position I – for single bomb release, II – for pair release from 2 hardpoints simultaneously **[Ralt + Rshift + B]**. This rotating switch is can be rotated only clockwise. More details about electrical release box operation can be found in [11.5](#)

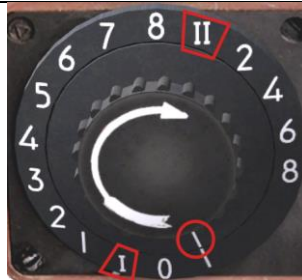

- b) enable the ESRB **[Ralt + B]** (to the right)



- c) release bombs, by pressing the KSB-49 bomb release button (3D-model is not present in the game) **[B]** and check that corresponding light panels on the co-pilot's armament control panel or pilot's upper armament control panel go off.

## 12.4. Enabling the equipment during combat deployment

### 12.4.1. Before taxi (takeoff)

Before weapons can be employed, all of the relevant systems must be switched on (see [12.3](#)). Some systems (components) are switched on prior to takeoff while others are switched on only in the combat area (to avoid unintended weapons fire). Normally, all of the relevant systems are switched on prior to takeoff, apart from the weapon systems main power switches. The Mi-8MTV2 weapon systems has three master switches for different types of weapon:

- ГЛАВНЫЙ ВЫКЛЮЧ РС ГУВ (RKT-GUN MASTER switch) – connects firing circuits for launching rockets, firing UPK-23-250 and GUV-1;
- ГЛАВНЫЙ ВЫКЛЮЧ МВ (MINELAYING SYSTEM MASTER switch) – connects circuits for launching mines from cartridges (not used in the game);
- ГЛАВНЫЙ ВЫКЛЮЧ. БВ (BOMBS MASTER switch) – connects bomb release circuit.

Besides that, after checking bomb armament, the bomb's master arm switch together with ESBR are normally switch off.

1. Before takeoff, enable armament according to the chapter [12.3](#). To avoid unauthorized firing or bomb release, disable the ГЛАВНЫЙ ВЫКЛЮЧ РС ГУВ (RKT-GUN MASTER switch) switch on the pilot's upper armament control panel and the ГЛАВНЫЙ ВЫКЛ БВ (BOMBS MASTER switch) switch on the co-pilot's weapon control panel (in addition, disable the ESBR on the electrical release box).

2. Set the required elevation angle on the [PKV collimating sight](#) for the given attack profile (weapon type, flight profile, target range). Use the mouse or keyboard **[LCtrl + O]** – **[Lalt + O]** shortcuts to turn the PKV elevation angle knob to set the required elevation angle. If desired, utilize the PKV snapview as described above (see [14.4.2.](#)). The [required PKV elevation angles](#) for various weapons and attack profiles are provided below:

- for employment of B8V20A rocket launchers from level flight in [Table 12.2](#), [Table 12.3](#)
- for employment of B8V20A rocket launchers from a dive in [Table 12.4](#)
- for wind correction during employment of B8V20A rocket in [Table 12.5](#)
- for employment of UPK-23-250 in level flight in [Table 12.6](#)
- for employment GUV-8700 YakB 12.7-mm guns in [Table 12.7](#)
- for employment GUV-8700 GShG-7.62 mm guns in [Table 12.8](#)
- for employment GUV-8700 AP-30 automatic grenade launcher in [Table 12.9](#)
- for bombing from low altitudes using the PKV collimating sight in [Table 12.10](#)

3. Prior to flight (takeoff), it is recommended to prepare, in particular for the attack phase, by mentally picturing the sequence of events: target search, aiming, aim adjustment based on conditions, exiting the attack, checking for threats or return fire.

4. As experience with employment of rocket and cannon/gun systems increases, the interval between subsequent salvos of fire tends to close to 3 – 5 seconds. At an airspeed of 180 – 200 kph the helicopter closes approximately 250 – 285 meters or range to the target, requiring a nose down aim adjustment of approximately 3 – 6 mils (1/2 reticle subtension). Additionally, any speed increase also requires an aim adjustment. For example an increase of 20 kph requires a reduction of elevation by 4 – 5 mils (1/2 reticle subtension).

As such when initiating a rocket or cannon/gun attack run at maximum range, raise the reticle cross above the target in accordance with the calculated adjustment. As the target range closes toward minimum range, lower the reticle cross by approximately 1 subtension (10 mils) for each 5 seconds of flight time at 200 kph (see [Fig. 12.2](#)). If airspeed increases in the attack run to 250 kph, the reticle adjustment during the attack may be as high as 2 – 3 subtensi

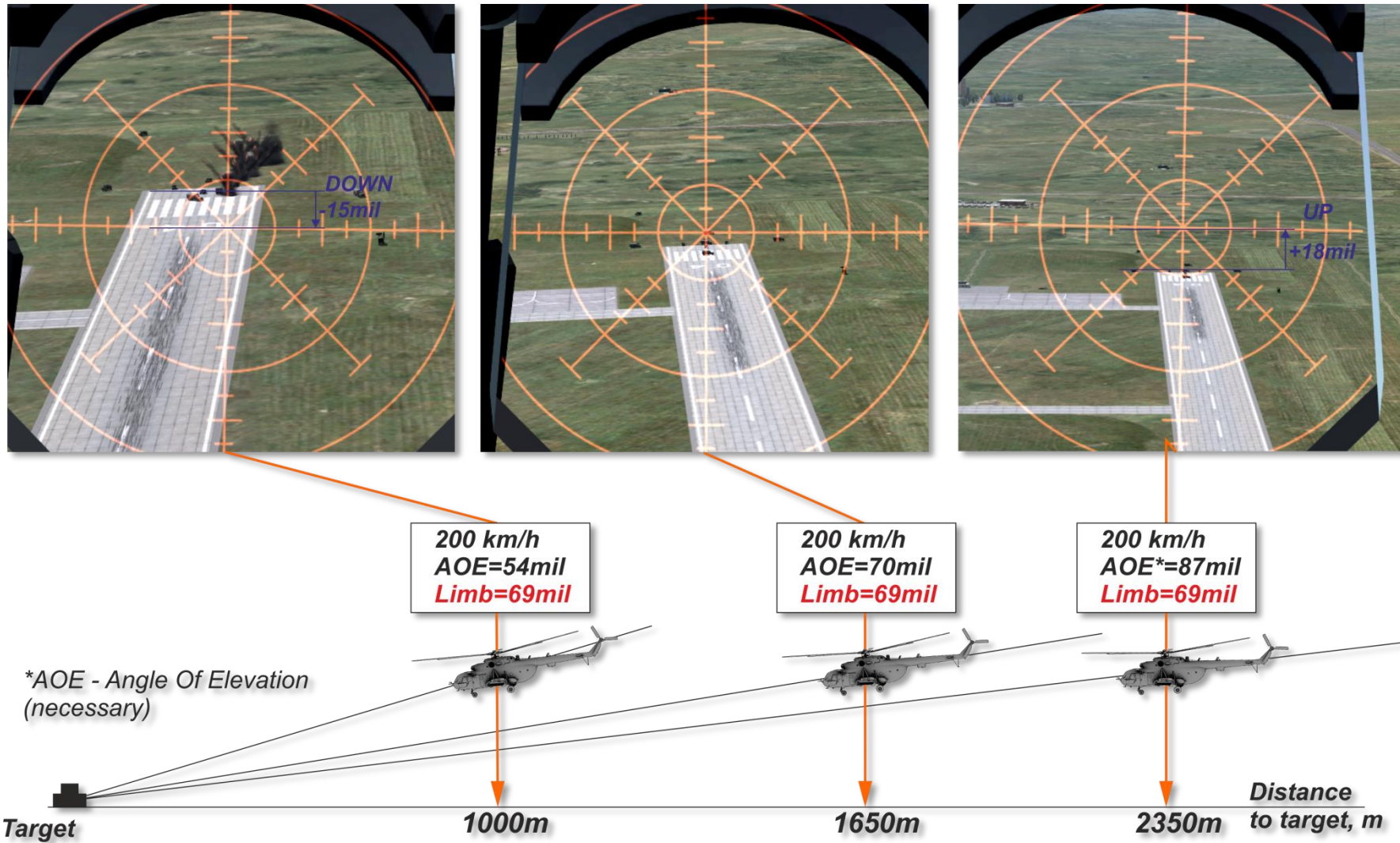

Fig. 12.2. Estimated required target elevation angle in three points of the attack run without adjusting the PKV elevation knob

## 12.4.2. The required PKV elevation angles for various weapons and attack profiles

*SIGHT ELEVATION FOR EMPLOYMENT OF B8V20A ROCKET LAUNCHERS FROM LEVEL FLIGHT:*

**Table 12.2**

Target range at launch, m	Sight elevation setting for <b>S-8KOM</b> (and other types with mass of 11 - 12 kg) from <b>B8V20A</b> launchers from level flight, in mils, for various airspeeds, in kph			
	100		100	
1000	82	1000	82	1000
1500	90	1500	90	1500
2000	100	2000	100	2000
2500	114	2500	114	2500
3000	128	3000	128	3000
3500	146	3500	146	3500

**Table 12.3**

Target range at launch, m	Sight elevation setting for <b>S-80FP2</b> (mass 16.7 kg) from <b>B8V20A</b> launchers from level flight, in mils, for various airspeeds, in kph			
	100		100	
1000	100	1000	100	1000
1500	112	1500	112	1500
2000	125	2000	125	2000
2500	139	2500	139	2500
3000	152	3000	152	3000
3500	169	3500	169	3500

[return to unguided rocket system description](#)  
[return to PKV collimating sight description](#)

*SIGHT ELEVATION FOR EMPLOYMENT OF B8V20A ROCKET LAUNCHERS FROM A DIVE:*

**Table 12.4**

Dive angle, deg	Dive entry airspeed, kph	Airspeed at launch, kph	Target range at launch, m	Sight elevation setting for employment of <b>B8V20A</b> launchers of various rocket types from a <b>dive</b> , mils S-8KOM
10	150	180	1500	68
			2000	74
			2500	82
			3000	92
			3500	104
20	150	200	1500	64
			2000	70
			2500	78



			3000	88
			3500	98
			4000	110
			4500	128

*WIND CORRECTION (B8V20A):*

**Table 12.5**

Wind direction on attack course, deg	Wind speed, m/s	Wind correction, mils
		S-8KOM
30°; 150°; 210° и 330°	5	5
	10	10
	15	15
60°; 120°; 240° и 300°	5	8
	10	17
	15	25
90° и 270°	5	10
	10	19
	15	29

*SIGHT ELEVATION FOR EMPLOYMENT OF UPK-23-250 IN LEVEL FLIGHT:*

**Table 12.6**

Indicated airspeed, kph	Sight elevation settings for employment of <b>GSh-23L</b> cannon ( <b>UPK-23-250</b> pod) against ground targets from level flight at various target ranges, in mils					
	500 m	1000 m	1500 m	2000 m	2500 m	3000 m
0	48	56	72	90	—	—
100-250	44	54	66	84	102	123

*SIGHT ELEVATION FOR EMPLOYMENT GUV-8700 YAKB 12.7-MM GUNS:*

**Table 12.7**

Dive angle, deg	Target range, m	Sight elevation settings for employment of <b>YakB-12.7</b> (GUV), in mils, for various airspeeds, in kph				
		0	100	150	200	250
0	500	65	65	65	60	60
	1000	70	70	70	65	65
	1500	80	80	80	75	70
	2000	95	95	90	90	85
10	500	—	—	60	60	55
	1000	—	—	65	65	60
	1500	—	—	75	70	65
	2000	—	—	85	85	80
20	500	—	—	55	50	45
	1000	—	—	60	55	50
	1500	—	—	70	65	60
	2000	—	—	80	75	70
30	500	—	—	45	40	—
	1000	—	—	50	45	—
	1500	—	—	60	55	—

	2000	-	-	70	65	-
--	------	---	---	----	----	---

*SIGHT ELEVATION FOR EMPLOYMENT GUV-8700 GSHG-7.62 MM GUNS:*

**Table 12.8**

Dive angle, deg	Target range, m	Sight elevation settings for employment of <b>GShG-7.62</b> (GUV), in mils, for various airspeeds, in kph				
		0	100	150	200	250
0	500	65	60	60	60	55
	1000	70	70	70	65	65
	1500	90	90	85	85	80
	2000	120	120	115	110	105
10	500	-	-	60	55	55
	1000	-	-	65	65	60
	1500	-	-	85	80	65
	2000	-	-	110	110	80
20	500	-	-	50	50	45
	1000	-	-	60	55	50
	1500	-	-	75	75	60
	2000	-	-	100	100	70

*SIGHT ELEVATION FOR EMPLOYMENT GUV-8700 AP-30 AUTOMATIC GRENADE LAUNCHER:*

**Table 12.9**

Dive angle, deg	Target range, m	Sight elevation settings for employment of <b>AP-30</b> (GUV), in mils, for various airspeeds, in kph						
		100	140	160	180	200	220	250
0	800	80	70	65	60	50	45	30
	1000	115	105	100	90	85	75	60
	1500	225	200	190	175	165	155	135
	2000	-	-	-	-	-	245	225
10	800	-	70	65	60	50	40	30
	1000	-	105	100	90	80	70	55
	1500	-	195	185	175	160	150	130
	2000	-	-	-	-	-	237	217
20	800	-	65	60	50	40	30	-
	1000	-	90	85	75	70	60	-
	1500	-	175	165	155	145	130	-
	2000	-	-	-	240	220	215	-

**N O T E .** Generally multiple bursts are assumed in an attack run, but adjusting the sight elevation setting between bursts is not practical as there is not sufficient time in the attack. Given the attack plan (starting target range, ending target range, weapons planned for employment, etc), a maximum and minimum range is calculated. The sight elevation setting is set to the average range between the calculated maximum and minimum ranges. When planning the attack, the difference between the resultant sight elevation setting and the closest matching setting in the chart is taken as a basis for calculating high or low correction on the reticle sight during the attack phase. For example see (Fig. 12.2). In the simulation, the default sight elevation setting is 69 mils, which can be taken as a basis for calculating the required reticle correction in the attack phase.

*SIGHT ELEVATION FOR BOMBING FROM LOW ALTITUDES USING THE PKV COLLIMATING SIGHT:*

**Table 12.10**

Altitude, m	Sight elevation setting, in mils, for various ground speeds, in kph										
	Release delay, sec										
	150	160	170	180	190	200	210	220	230	240	250
50	200	200	200	200	183	174	165	157	149	140	123
	1.0	0.5	0.5	—	—	—	—	—	—	—	—
100	200	200	200	200	200	200	200	200	200	200	200
	3.0	2.5	2.0	2.0	1.5	1.0	0.5	0.5	0.5	—	—
Release delay, sec											
150	6.0	5.5	5.0	4.5	4.0	3.5	3.0	2.5	2.0	1.5	1.0
200	8.5	7.5	7.0	6.5	6.0	5.5	5.0	4.5	4.0	3.5	3.0
250	11.5	10.5	10.0	9.5	8.5	8.0	7.0	6.0	5.5	5.0	4.5
300	15.0	14.0	13.0	11.5	10.0	9.5	9.0	8.5	7.5	6.5	6.0

**N O T E**

1. The required sight elevation setting must be set by rotating the elevation knob on the PKV collimating sight. For example, for a release from an altitude of 50 m at 200 kph, the elevation setting must be set to 174 mils, as demonstrated in (Fig. 12.3).
2. Release delay - the time delay between the target passing through the **bottom point of the outer reticle ring** (along the center vertical line or displaced to either side in case of crosswind or sideslip) and bomb release.
3. When employing bombs from low altitude, a fuze delay setting is used to avoid damaging the helicopter and crew (not currently implemented)

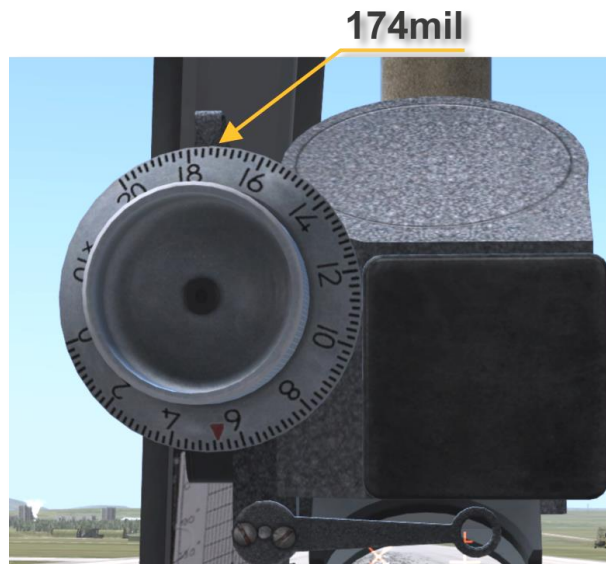

**Fig. 12.3. Setting 174 mil elevation on the PKV sight**

### 12.4.3. Attack run

1. The approach to the target area must be planned and flown so as to minimize the chances of detection by hostile forces and engagement by hostile air defense assets. Low altitude to nap-of-the-earth (NOE) flight is generally most effective at minimizing exposure to threats.

When employing rockets or cannon/gun systems, generally the most effective flight profile in the attack is level flight with an airspeed of 180 – 200 kph in the initial phase followed by a shallow dive (5 – 10°) in the aiming and firing phase. Once stabilizing at this airspeed, re-trim the autopilot by neutralizing the deviations on the autopilot zero indicator, trim the flight controls, take note of the collective pitch angle



(this will be helpful in re-establishing level flight after the attack).

2. Turn on the **RKT-GUN MASTER switch** and/or **BOMBS MASTER switch** and ESBR as required depending on employed weapon system.

<p>1. The ГВ РС ГУВ (RKT-GUN MASTER switch) if rockets, UPK-23-250 or GUV-1 to be deployed</p>	<p>2. The ГВ ББ (BOMBS MASTER switch) and ESBR if bombs to be deployed</p>

(One must remember, that all other, needed circuit breakers and switches must be enabled before taxiing and takeoff, see [12.3](#)).

3. At a range of 3000 – 2500 m, perform a pop-up maneuver to gain visual contact with the target. This can be done either using the cyclic to increase pitch by +10 – 15° or using the collective to increase collective lift. Once attack altitude is reached, return to level flight by either reducing pitch or collective depending on the method used to perform the pop-up maneuver.

**N O T E .** Although the second (collective) option for performing the pop-up maneuver is less “pretty”, it is nevertheless preferable as it maintains line of sight to the target, avoids increasing own helicopter’s area of exposure to air defense fire, and prevents a loss of airspeed in the pop-up maneuver.

4. At the attack altitude, set the collective pitch as required for level flight (angle noted prior to the pop-up maneuver), search for and identify the target, perform any required heading corrections to line up with the target, and eliminate any climb/descent to maintain level flight.

**N O T E .** Remember that weapons fire in conditions of vertical speed or side slip becomes highly inaccurate. Rocket and cannon and machine gun rounds will fall short if fired in a negative vertical velocity condition and fall long if fired in positive vertical velocity condition. If fired with side slip, the rounds will tend to fall toward the side of the slip ball. Rockets are particularly sensitive to poor firing conditions due to their (relatively) low initial velocity of 30 – 50 m/s.

If the attack heading is taken out of a turn, the leveling of the turn should be when the remaining turn angle approximately equals the turn roll angle, i.e. if the roll angle in the turn is 40°, begin to level out of the turn onto the attack heading approximately 40° short of the attack heading. Remember that turns with large roll angles (exceeding 15°) result in a climbing tendency when the helicopter is leveled out of the turn, requiring a reduction in collective pitch by 1/8 – 1/6 travel.

Next steps:

#### **Employing rockets or cannon/gun systems:**

- a) After leveling out of the turn establish level flight at 180 – 200 kph, eliminate climb/descent rate, center the slip ball (to minimize dispersion)
- b) When employing rockets: at 2500 m perform final course corrections to place the target directly on course, place the sight reticle over the target with smooth cyclic control, adjust reticle position based on range and wind correction and initiate weapons fire at 2000 m by pressing the WEAPONS FIRE switch on the cyclic control handle. When firing the UPK-23-250 or GUV-1: begin firing at a distance of 1500 -1200 m
- c) If multiple salvos are planned, continue to close the range to the target while making aim corrections for the reduced range and, if required, increased airspeed (see [Fig. 12.2](#))
- d) Turn off the target prior to reaching minimum range (1000 m)

Rocket and cannon/gun fire produces a slight recoil which tends to pitch the helicopter down due to the payload being positioned below the CG. When firing long



salvos, plan for recoil effects by correcting the reticle position 3 – 5 mils higher to allow for recoil drop during the fire sequence.

### **Bomb delivery by the pilot using the PKV collimating sight:**

- a) Plan the attack run such that it take 10 – 15 sec between initial point and release points. As experience grows, this time can be reduced.
- b) If no crosswind is present, maintain the attack heading such that the helicopter flight path crossed directly over the target. In this case, the PKV reticle cross should cross over the target as well.
- c) In a crosswind condition, the PKV sight picture has to be adjusted so that the vertical bar passes to the left (right) of the target at an angle equal to the slip angle in the opposite direction
- d) In a head or tailwind condition (as well as no wind), bombs are released when the target passes through the bottom of the outside ring of the reticle ([Fig. 12.4](#));

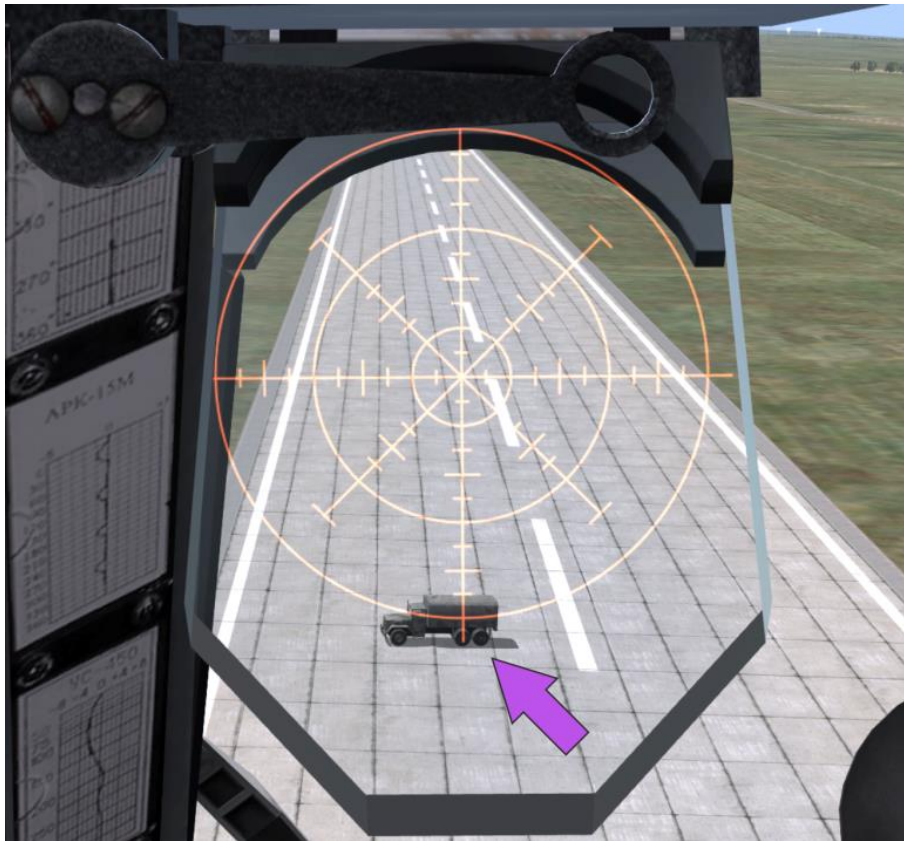

**Fig. 12.4. Bomb release point in calm weather or only head/tailwind; altitude 50 m**

- e) In a crosswind condition, bombs are released when the target passes through an imaginary horizontal line that is tangent to the bottom point of the outside ring of the reticle ([Fig. 12.5](#));

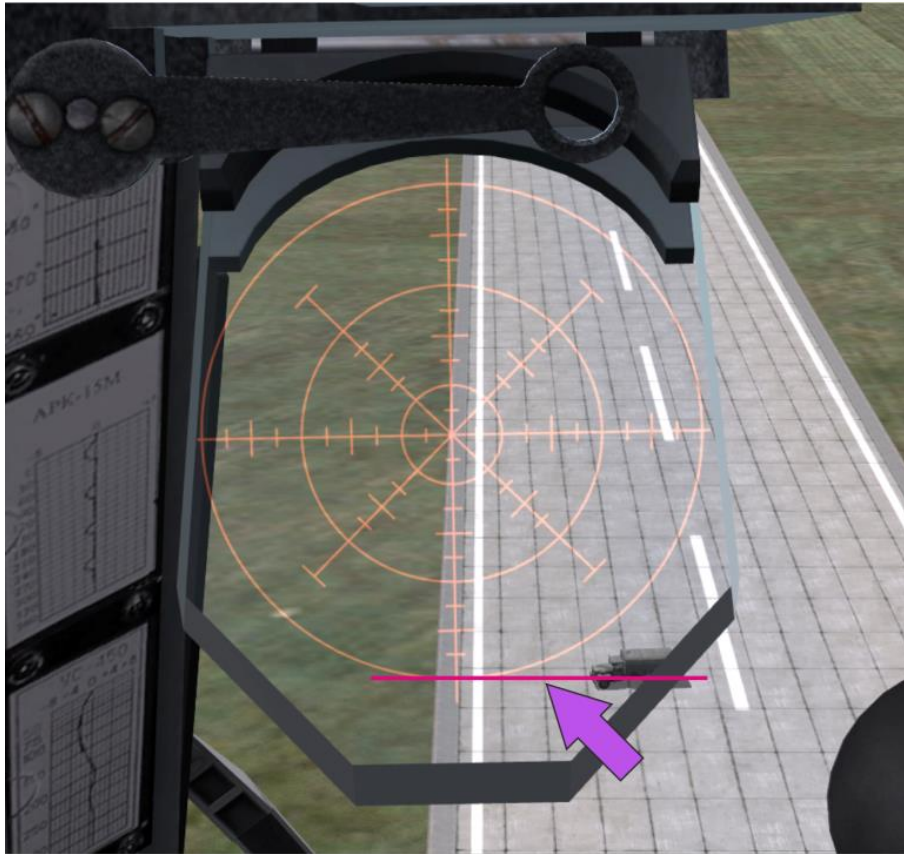

**Fig. 12.5. Bomb release point in a LEFT crosswind condition; altitude 100 m**

- f) If the target line of sight passes under the PKV reticle visible view angles, the bomb release point is estimated using a countdown. In this case the PKV elevation is set to the lowest angle of 200 mils.
- g) After the target passes through the intersection of the reticle vertical bar and outside ring, the pilot begins the countdown and releases the bombs upon completing the countdown..

Bombs released from low altitudes and set for delayed detonation may bounce and detonate further afield.

#### **12.4.4. Exiting the attack**

1. After completing weapons fire, perform an energetic maneuver away from the target while descending to low altitudes and increasing airspeed to maximum of 230 – 250 kph. To minimize exposure to hostile air defenses, perform evasive maneuvering: alternating left and right turns of 30 – 40° bank and 40 – 50° heading (4 – 5 sec) until reaching 1000 – 1500 m of range off the target.

If required, repeat the attack pass(es).

2. When the attack is complete, switch OFF the RKT-GUN MASTER and/or BOMBS MASTER switches.

3. Navigate to the landing point.

### 12.4.5. Firing the 12.7-mm KORD and 7.62 PKT machine guns

There are two machine gun stations in the Mi-8. The 12.7-mm machine gun is installed in the doorway of the cargo bay (further "door gunner") and 7.62-mm PKT machine gun in the right cargo bay door (further "tail gunner" or "aft gunner"). These machine guns can be fired by gunners at any time. Gunners are implemented as AI, but player can control their behavior (ROE) during the game. In addition to that, player can play as a gunner of the 12.7-mm KORD machinegun.

#### *Control of AI-gunners*

Player can control AI-gunners by selecting one of three ROE options:

- HOLD – gunners will not fire;
- RETURN FIRE (RET. FIRE) – gunners will fire back if the helicopter is under fire;
- FREE FIRE – gunners are free to engage any detected target up to distance of 800 m. If there are multiple targets, AI-gunner tries to engage all of them, but most dangerous targets have higher priority.

By default, the HOLD option is selected. Current status is indicated in kneeboard, ROE column, or in the on-screen hint panel (text on transparent background) while playing from the gunner place.

#### To change the behavior of the AI-gunners player must:

1. Activate kneeboard **[Rshift + K]** or **[K]** (to briefly show kneeboard) to see the current status of the armament and gunners:

CREW STATUS:				
HEALTH	ROE	AMMO	BURST	
PILOT	PLAYER	-	-	
1 → LH GUNNER	3 → RET. FIRE	4 → 61	5 → SHORT	6 → LC+LW+4
2 → BK GUNNER	3 → FREE FIRE	4 → 100	5 → SHORT	6 → LC+5

**Fig. 12.6. AI-gunners status in the kneeboard**

- |   |   |
|---|---|
| 1. Door gunner                              | 4. Remaining ammo in percents                       |
| 2. Tail gunner                              | 5. Burst length (can not be changed here)           |
| 3. Current rules of engagement (ROE) status | 6. Hotkeys for changing ROE (LC – LCtrl, LW – Lwin) |

2. By the **[LCtrl + Lwin + 4]** key command (pressing sequentially) for the door gunner and by the **[LCtrl + 5]** for the tail gunner, select the desired ROEs and check them in the kneeboard.

AI-gunners fire short bursts: from 12.7-mm machinegun – 5..7 rounds, from 7.62-mm machinegun – 7..10 rounds.

### *First person playing with the 12.7-mm KORD machinegun*

To take a gunner's place (first person view), player must press the **[4]** key, as a result, the player takes a seat of the gunner and the gunners' status transparent panel appears in the bottom-right corner:



**Fig. 12.7. First person view from the door gunner's seat**

Activate/remove the gunner status panel – **[Lwin + H]**.

This status panel contains the same information as the kneeboard, except that remaining ammo is shown not in the percentage from the total ammo, but in rounds and which ammunition belt is used, starting from the belt №12 and to the belt №1



In the example here, 16/8 means that there are 16 rounds in the ammunition belt №8 (from 12 available) for the 12.7-mm KORD machine gun. Similarly for the 7.62-mm PKT machine gun.

First person view and machine gun are controlled by the mouse:

- mouse movement left-right moves machine gun to the left-right correspondingly;
- mouse wheel rotation zooms in/out the iron sight.

For aiming, by using the mouse wheel, zoom-in the iron sight of the machine gun:



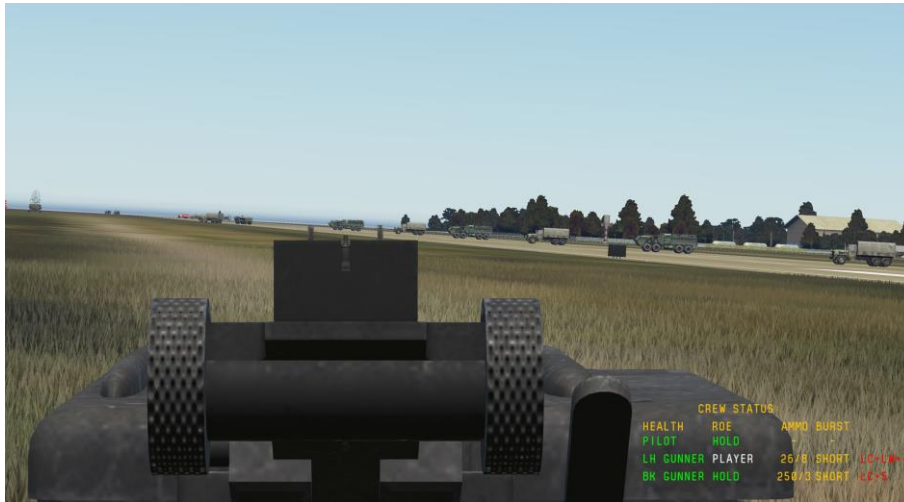

and aligning the front sight post or "bead" with the aperture or "crook" and target, [Fig. 12.8](#):

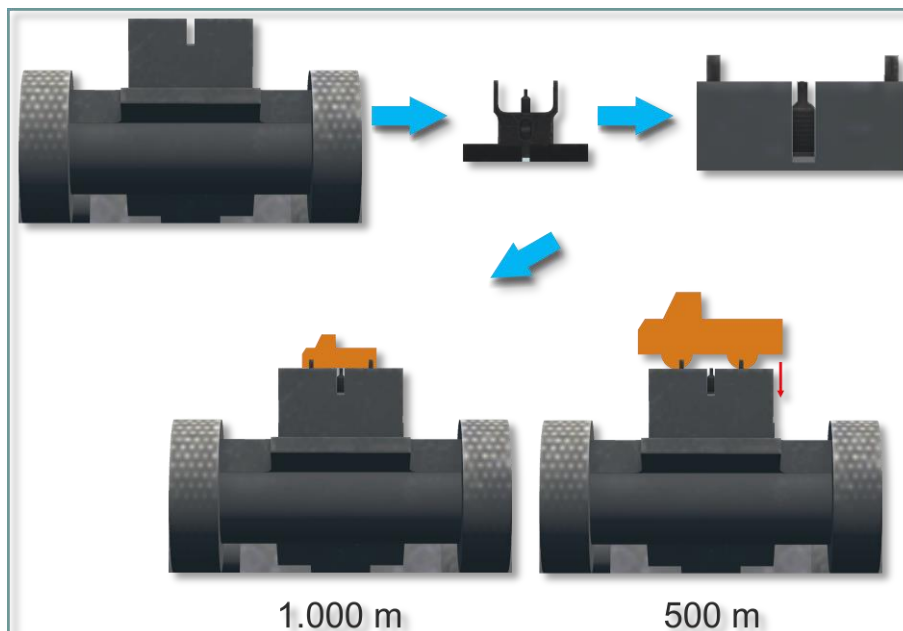

**Fig. 12.8. Aiming the machine gun**

Iron sights of the machine guns are set to 1,000 m, and if shooting at a target at approximately this distance, one must aim under the lower edge of the target. If shooting is performed at smaller distances, one must lower the "bead-crook" line below target.

Firing guns is performed with help of the left mouse button.

***Use of head tracking devices (of TrackIR type) while playing as a gunner***

In case, if in addition to existing input devices (keyboard, mouse, joysticks) there is a head tracking device (TrackIR), views and gun can be controlled in three different ways:



- TrackIR controls view, mouse – gun (default behavior, when taking gunner seat);
- TrackIR controls both view and gun;
- TrackIR is disabled by the hot-key from TrackIR program **[F9]**, and then mouse controls view and gun.

Modes can be change sequentially by the command **[Lalt + T]**.

**N O T E** . Simultaneous use if input devices was tested and tuned only for officially supported TrackIR devices, correct functioning with other similar devices was not tested.

### ***Key commands for playing as a gunner***

Key combination	Function
<b>[4]</b>	Take the door gunner's place
<b>[1]</b>	Take the pilot's place
<b>[Rshift + K]</b>	Aktivare kneeboard
<b>[K]</b>	Aktivare kneeboard (shown only while the key is kept pressed)
<b>[Lwin + H]</b>	Activate/ deactivate gunner's status panels while playing as a door gunner
<b>[LCtrl + Lwin + 4]</b>	Sets ROE of the door gunner
<b>[LCtrl + 5]</b>	Sets ROE of the tail gunner
<b>[Lalt + T]</b>	Switches simultaneous use of TrackIR and mouse modes
<b>[F9]</b>	Disables/enables TrackIR from its own software

## ***12.5. Emergency jettison of bombs and stores***

### **12.5.1. General descriptions**

Emergency jettison is used, when it is necessary to emergency jettison stores in the flight to reduce helicopter's weight in *EMERGENCY CASES* when *MAIN RELEASE SYSTEM* is not operational.

#### ***Cases, when all stores must be jettisoned***

Emergency jettison of the stores is always performed in the following emergency situations:



- failure of both engines (if there is an opportunity);
- when one engine has failed and sustained level flight without descending is not possible;
- when directional control has failed and decision to land is taken;
- when crew leaves helicopter and it can not be done safely with the stores present (not implemented);
- when bombs hang or if there was an explosion or fire in weapon containers or blocks (not implemented).

Helicopter is equipped with two panels, controlling jettison:

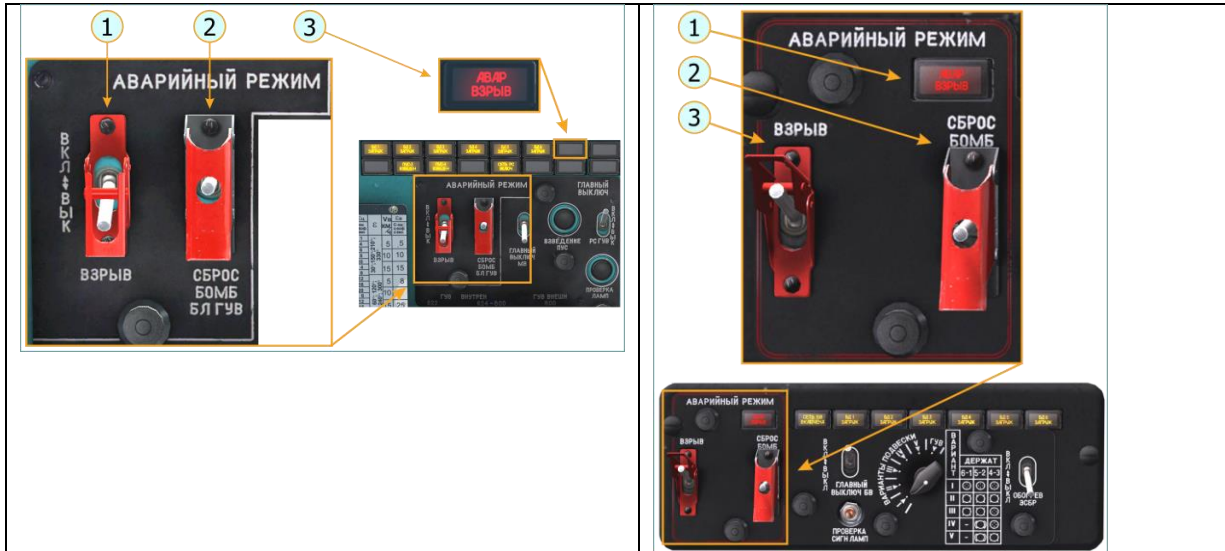
On the pilot's weapons control panel	On the co-pilot's weapons control panel
--------------------------------------	---



1. The ВЗРЫВ (ARMED) switch – in the ВКЛ (ON, up) position arms bombs;
2. The СБРОС БОМБ БЛ ГУВ (JETTISON BOMB ROCKET GUV) spring loaded jettison switch – when toggled to the upper position, opens all locks on external hardpoints;
3. Signal panel, indicating that bombs were emergency armed.

1. Signal panel, indicating that bombs were emergency armed.
2. The СБРОС БОМБ (BOMB JETTISON) – springloaded jettison switch – when toggled to the upper position, opens locks on external hardpoints with the following symbols  or ;
3. The ВЗРЫВ (ARMED) switch – in the ВКЛ (ON, up) position arms bombs

That is why emergency jettison can be performed from pilot's or co-pilot's place.

Jettison can be performed with armed or non-armed bombs, depending on positions of the "ВЗРЫВ" (ARMED) switches on weapons control panels. In the "ВЗРЫВ" (ARMED) position, bombs will be armed and explode when they touch the ground.

In case of emergency jettison from pilot's place, all stores will be jettisoned independently on store types, but if emergency jettison is performed from co-pilot's place, only bombs will be jettisoned, if they are present in the table on the bomb armament panel, see [Table 12.11](#).

**Table 12.11**

Payload profiles (on co-pilot's bomb armament panel)	What will be jettisoned by the co-pilot
	I – "all rocket launcher" – nothing will be jettisoned
	II – "all bombs" – jettison impulse is send to external hardpoints №1-6 simultaneously
	III – "bombs- rocket launchers" – jettison impulse is send to external hardpoints №1, 6, 2, 5 simultaneously
	IV – "bombs- rocket launchers" – jettison impulse is send to external hardpoints №2, 5 simultaneously
	V – "all bombs" – jettison impulse is send to external hardpoints №2, 5, 3, 4 simultaneously

When the rotating switch **ВАРИАНТЫ ПОДВЕСКИ (PAYLOAD PROFILE)** on the bomb armament panel is in the I, III and IV positions, the rocket launchers will not be jettisoned by the co-pilot with help of emergency jettison circuits.

Rocket launchers in those cases can be jettisoned by the pilot with help of the **СБРОС БОМБ БЛ ГУВ (JETTISON BOMB ROCKET GUV)** switch on the pilot's weapon control panel. If it is necessary to jettison everything by the co-pilot, switch the payload profile selector into positions II or V (in this case system will assume that bombs are present on all hardpoints).

### 12.5.2. Emergency jettison procedure for the pilot

To emergency jettison stores, pilot must check and perform the following actions:

<p><b>1. ACBs on the left circuit breaker panel</b> must be enabled (only those, needed for jettison, are shown)</p>	
--	--

**2. MASTER ARM SWITCHES** must be enabled.



**3. On Upper armament Control Panel:**

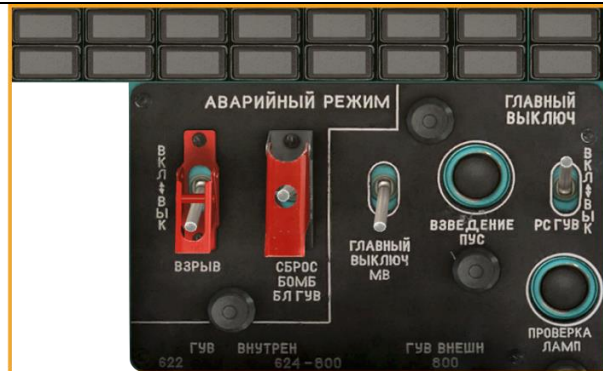

- a) if it is necessary to jettison **non-armed bombs**, open the safety cover of the jettison switch **[Lalt + ]** (1) and **perform jettison** **[ ]** (2)

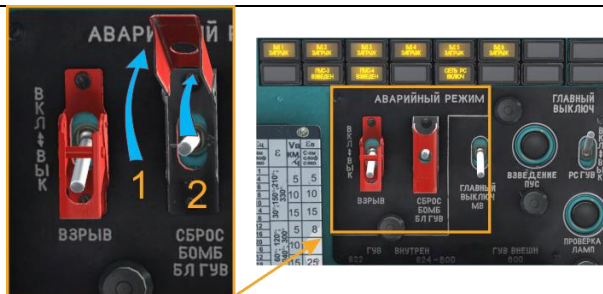



<ul style="list-style-type: none"> <li>b) if it necessary to perform jettison of <b>armed bombs</b>, then it is necessary to open safety cover of the ВЗРЫВ (ARMED) switch [Lalt + J] (1), and set this switch to the ВКЛ (ON, upper position) [H] (2), as a result signal panel АВАР ВЗРЫВ (JETTISON ARMED) goes on, after that <b>perform jettison</b> [J], see a).</li> </ul>	
<p>4. Make sure that bombs, rocket launcher and containers were jettisoned and corresponding signal lights went off;                  5. Set the СБРОС БОМБ БЛ ГУВ (JETTISON BOMB ROCKET GUV) switch to the ВыКЛ (OFF) position.</p>	

### 12.5.3. Emergency jettison procedure for the co-pilot

<p><b>1. ACBs on the left circuit breaker panel</b> must be enabled (only those, needed for jettison, are shown)</p>	
<p><b>2. MASTER ARM SWITCHES</b> must be enabled.</p>	
<p><b>3. On the Bombs control panel:</b></p>	



<ul style="list-style-type: none"> <li>a) check selected weapon profile, see <a href="#">Table 12.11</a></li> </ul>	
<ul style="list-style-type: none"> <li>b) if it is necessary to jettison <b>non-armed bombs</b>, open the safety cover of the jettison switch <b>[Ralt + U]</b> (1) and <b>perform jettison [U]</b> (2)</li> </ul>	
<ul style="list-style-type: none"> <li>c) if it necessary to perform jettison of <b>armed bombs</b>, then it is necessary to open safety cover of the ВЗРЫВ (ARMED) switch <b>[Ralt + I]</b> (1), and set this switch to the ВКЛ (ON, upper position) <b>[I]</b> (2), as a result signal panel АВАР ВЗРЫВ (JETTISON ARMED) goes on, after that open the safety cover of the jettison switch <b>[Ralt + U]</b> (3) and <b>perform jettison [U]</b> (4)</li> </ul>	
<p>4. Make sure that bombs were jettisoned and corresponding signal lights went off; 5. Set the СБРОС БОМБ (JETTISON BOMB) switch to the ВыКЛ (OFF) position and close it</p>	

with the xsafety cover.	
-------------------------	--



**13**

***SPECIAL TASKS***

## 13. SPECIAL TASKS

### 13.1. *Sling load operations*

Sling load operations are implemented in the game, see [Fig. 13.1](#)

Description of Sling load equipment see [7.10](#)



**Fig. 13.1. Mi-8MTV2 is flying with a sling load**

The most demanding stages of the external load operations are:

- hovering over the load and hookup;
- taking off with the load;
- transportation of cargo to the required area;
- approaching and hovering over the unhook point, load unhook.

In real life flights with a sling load are the most difficult ones. During such a flight crew is working very intensively. To partly compensate lack of the crew assistance, in this game several features, for sling load operations, were implemented. They can be activated by the player, or automatically, see below.

In addition, to play with a sling load, corresponding mission with cargos (loads), which belongs to player's coalition, must be created in mission editor.

#### 13.1.1. **Game features, related to sling load operations**

These features are intended to help player to hover precisely (position and altitude) above the cargo for hooking it up, as well as to assist during flight to designated area, approaching and hovering over the unhook area. These features are:

- smoke marking of the cargo from certain distance (2000 m), this feature is active, when cargo has been selected from the radio menu.
- external cargo indicator, which indicates position of the cargo relative to the cargo hook, as well as position of the helicopter, during hovering

above the cargo. This feature is engaged by the player and is working during hook up stage.

- automatic voice assistant (AI crew chief), which guides pilot where to and at which distance pilot must move helicopter to achieve precise hover over the load. This feature is automatic and is active during the following stages: hooking up the cargo, taking off with the cargo, flight to designated area, unhooking the cargo (if mission was properly prepared). Feature activation, see below;
- view from the helicopter's blister on the cargo (down, under the helicopter), which makes hovering over the cargo easier. This feature is activated manually by the player, works unconditionally.

**Cargo smoke marker**, (see [Fig. 13.2](#) ). It appears automatically, after the cargo was selected via radio menu (see, below). Cargo smoke marker is seen only by player, who selected corresponding cargo (in multiplayer missions).



Fig. 13.2. Cargo smoke marker

External cargo indicator, [Fig. 13.3](#).



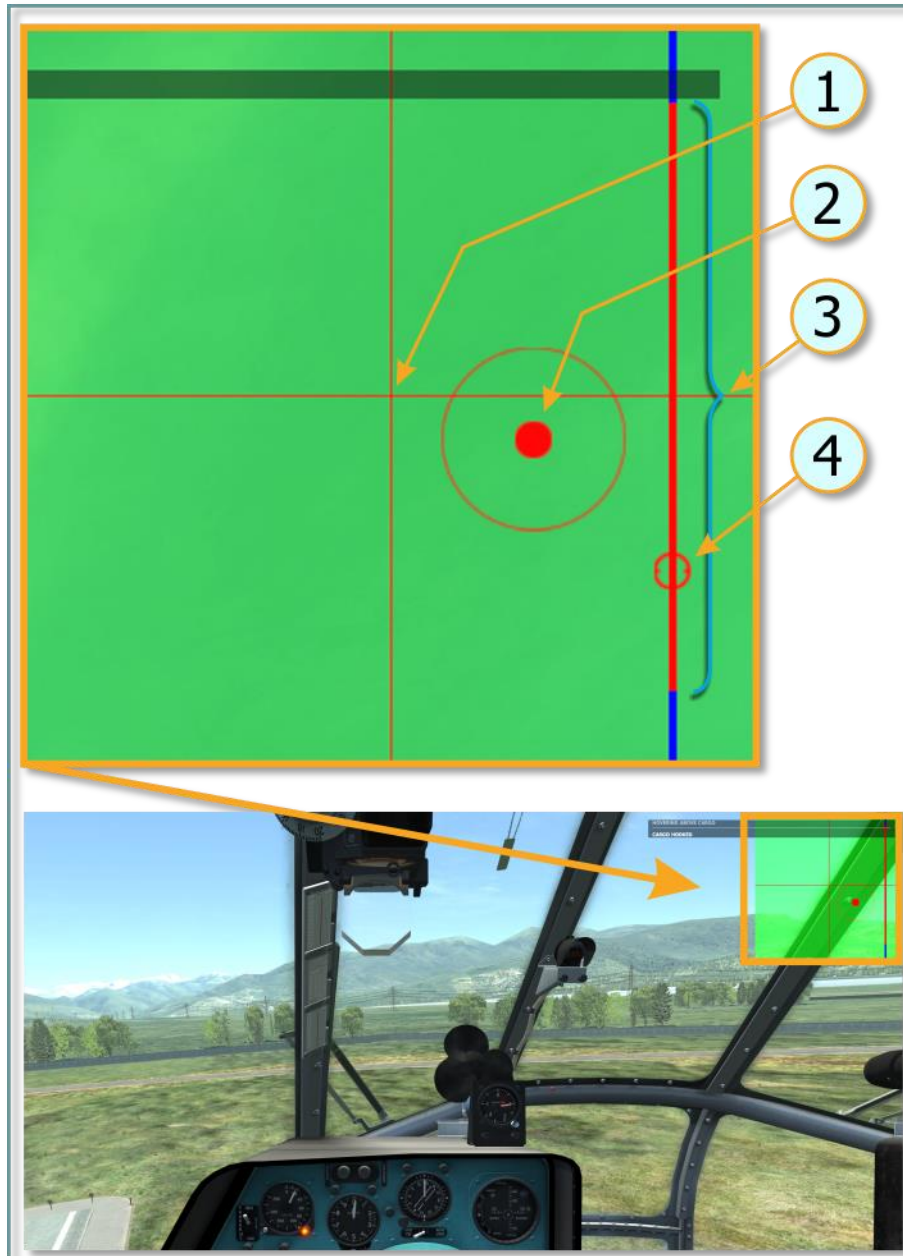

**Fig. 13.3. External cargo indicator**

- |   |  |
|---|--|
| <ol style="list-style-type: none"> <li>1. Projection of the cargo hook on the surface</li> <li>2. Cargo position</li> </ol> | <ol style="list-style-type: none"> <li>3. Allowed hoveraltitude range</li> <li>4. Indication of helicopter's altitude relative to the allowed altitude range (any position on the red line is OK)</li> </ol> |
|---|--|

Activation/deactivation of this indicator can be done after the desired cargo is selected using radio menu by pressing the **[RCtrl + Rshift + P]** combination.

**Automatic voice assistant (AI crew chief RU or EN)** by giving voice command, helps:

- while hovering over the cargo for hooking it up – is giving commands, which help to position the helicopter precisely above the cargo, informs when cargo is hooked up;

- while taking off with a sling load – is informing about cargo condition and it's altitude off the ground;
- while flying to the designated area – is informing about cargo oscillations, and if cargo is lower than 60 meters above the ground;
- while hovering over the unhook point/ drop zone (if this point is created in mission editor, see below), is giving commands to position the helicopter over the unhook point, informs, when cargo touches the ground.

While hovering above the cargo, the AI crew chief engages, when distance to the cargo is less than 10 m. on X,Y,Z (i.e if at least one of the distances is less than 10 m.). While approaching unhook point, the AI crew chief engages if distance from cargo to center of the unhook point is less than 50 meters. Commands, given by the AI at different stages of flight, are listed in Table 13.1.

**Table 13.1**

Flight stage, description of the situation, guiding where to move the helicopter, various information	Phrases of the AI crew chief (numbers are meters)
<b>Hovering over cargo</b>	
increase your altitude at ..	up – meter (2, 3, 5, 10, 15, 20, 30, 50, 60, 100, 150)
decrease your altitude at ..	down – meter (2, 3, 5, 10, 15, 20, 30, 50, 60, 100, 150)
move forward at ..	forward – meter (2, 3, 5, 10, 15)
move backward at ..	back – meter (2, 3, 5, 10, 15)
move left at ..	left – meter (2, 3, 5, 10, 15)
move right at ..	right – meter (2, 3, 5, 10, 15)
<b>Hooking up a cargo</b>	
helicopter is hovering precisely over the load	in position
load is hooked and hook lock is locked automatically (or manually by pressing corresponding key combination)	load is hooked
smoothly tighten the slings	slings are coming tight
slings are tight	slings are tight
helicopter is hovering at required altitude over the load (altitude is equal to sling length + load height)	at altitude
keep required altitude (altitude is equal to sling length + load height)	hold this altitude
<b>Takeoff with a sling load</b>	
Load is still on the ground	load is on the ground
Load is lifted at one meter off the ground	load is one meter off the ground
Load is lifted at three meters off the ground	three off the ground
Load is lifted at five meters off the ground	five off the ground
Sling load's behavior in the air is normal, as expected, pilot can start accelerating	Load is cleared for flight
Load is at ten meters off the ground	ten off the ground
Load is at fifteen meters off the ground	fifteen off the ground
Load is at twenty meters off the ground	twenty off the ground

<b>Flight to the designated area (drop zone)</b>	
The load is swinging fore and aft	the load is swinging fore and aft (3, 5, 10, 15, 30)
The load is swinging side to side	the load is swinging side to side (3, 5, 10, 15, 30)
Swinging of the load disappeared (eliminated)	load is hanging steady
Load is at (60, 50, 30, 20, 15, 10, 5, 3, meter) off the ground	(60, 50, 30, 20, 15, 10, 5, 3, meter) of the ground
<b>Approaching and hovering over drop zone, load unhook</b> (if trigger is used to mark the drop zone)	
Load is at (60, 50, 30, 20, 15, 10, 5, 3, meter) off the ground	load is (60, 50, 30, 20, 15, 10, 5, 3, meter) off the ground
increase your altitude at ..	up – meter (2, 3, 5)
decrease your altitude at ..	down – meter (2, 3, 5)
move forward at ..	forward – meter (2, 3, 5, 10, 15, 20, 30, 50)
move backward at ..	back – meter (2, 3, 5, 10, 15, 20, 30, 50)
move left at ..	left – meter (2, 3, 5, 10, 15, 20, 30, 50)
move right at ..	right – meter (2, 3, 5, 10, 15, 20, 30, 50)
helicopter hovers precisely over the drop zone ( $\pm 2,5$ m)	in position/ over drop zone
load is on the ground, unhook the load	on the ground, release

In case if load is to be released at drop zone/unhook zone without trigger, the voice assistant will help to control altitude of load above the ground with the following phrases: "60 off the ground", "50 off the ground", "30 off the ground", "20 off the ground", "15 off the ground", "10 off the ground", "5 off the ground", "3 off the ground", "meter off the ground", "on the ground, release".

After the "on the ground, release" phrase, the automatic voice assistant (AI crew chief RU or EN) stops functioning, until the next load is selected.

Keep in mind that during vigorous maneuvers in hookup or drop zone (altitude and position), information, given by the AI crew chief, quickly became outdated.

**View from blister on the cargo** ([Fig. 13.4](#)) is used to control hovering position, when normal view on the cargo is blocked by the fuselage, is activated/deactivated by the [**Lshift + Lalt + C**] keys,

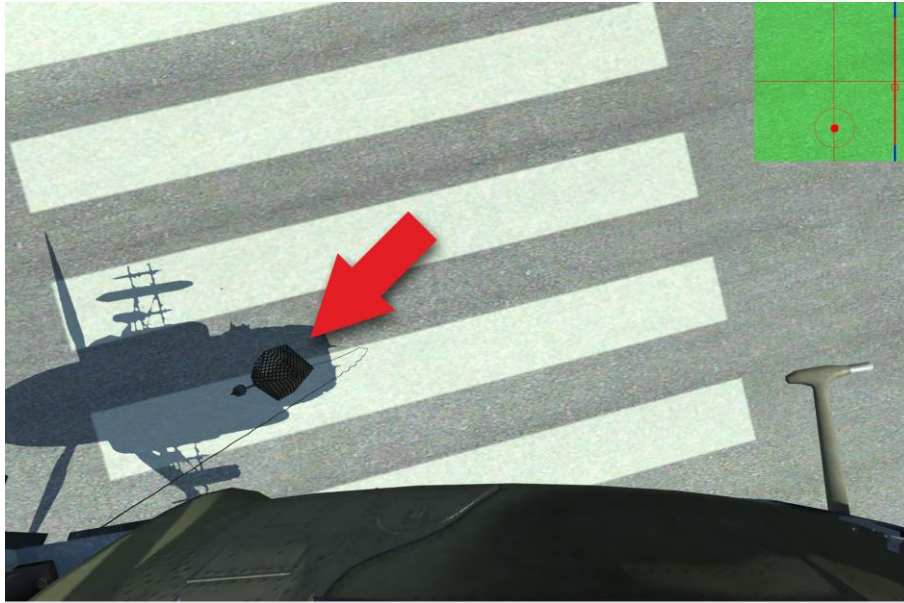

**Fig. 13.4. View from the blister on the cargo**

View from the blister is implemented from both pilot's and co-pilot's places.

It is highly recommended to assign this view on one of the joystick's buttons and use for a short periods of time while hovering over the cargo.

### **13.1.2. How to prepare a flight mission with a sling load**

#### ***Placing cargo on map and adjustment of the sling length***

To create a sling load mission, player must follow the flow chart below (see [Fig. 13.5](#)):

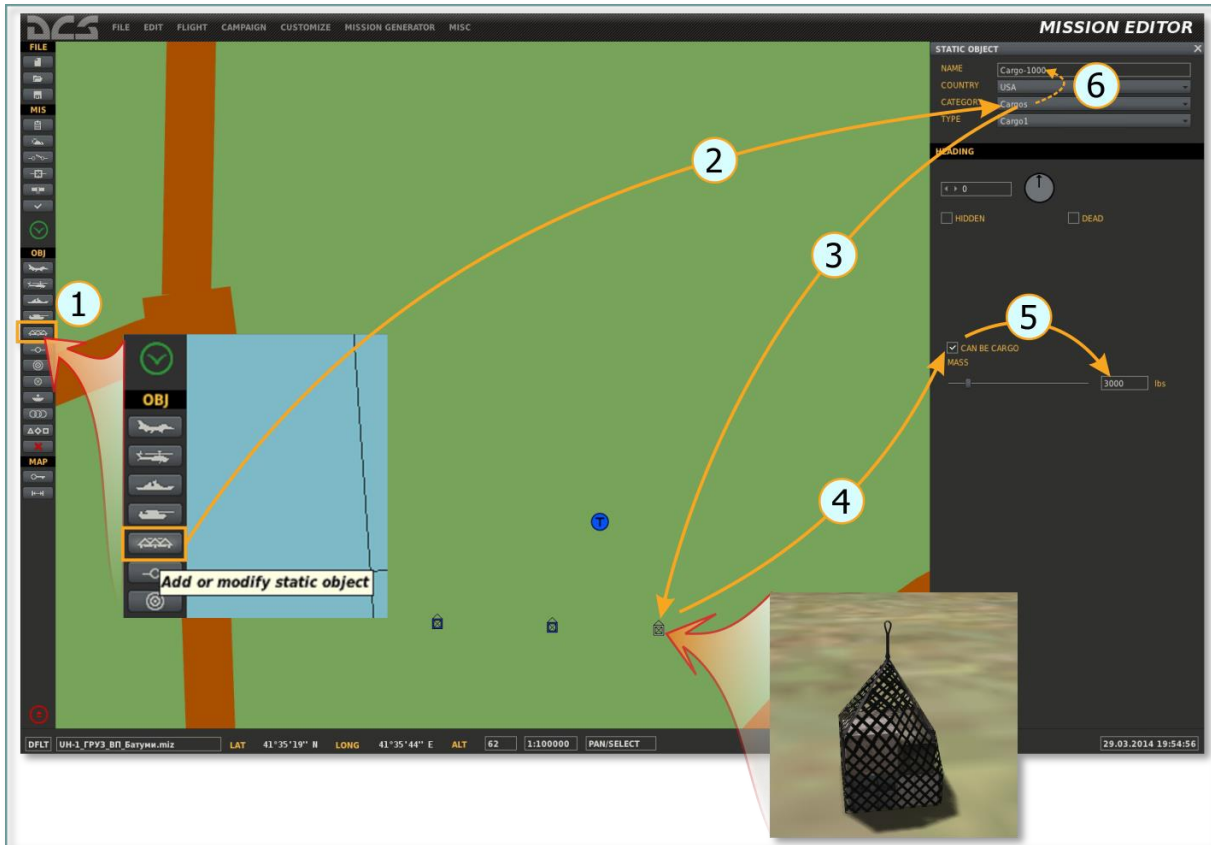

Fig. 13.5 Flow chart explaining creation of the mission with a sling load



1. Press the "Add or modify static object" ;
2. Select the CATEGORY – "Cargos" from the drop-down list, TYPE – "Cargo-1 (or xx)":





3. Place the cargo on the map (left button click);
4. Set the "CAN BE CARGO" flag (this allows this cargo to be selected and hooked up):



5. Set the required cargo weight (if available weight change), for beginners, around 500kg (1100lbs) is recommended;
6. Rename this object (cargo) (recommended), for example "LOAD-500" or "CARGO-1300". It makes selection of the desired cargo, using radio menu, easier.
7. Adjust the length of the rope (maximum 30m), for beginners 10-15m is recommended:

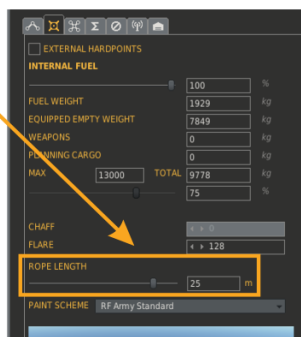

8. Save the mission, this concludes mission creation.

Created, in this way mission, allows player to hook up the cargo, transport and unhook the cargo at any place (unhook zone is not designated and thus smoke marking of the unhook zone and AI crew chief will not be functional).

To create a more advanced mission, where player must unhook cargo precisely at designated area, using advanced features like marking of the unhook zone with a smoke and AI crew chief assistant, a trigger area of the unhook zone type must be added.

### Creation of the unhook zone

To have a possibility of marking the unhook zone with a smoke and use the automatic voice assistant (AI crew chief, see below), is necessary:

1. Place a trigger zone, give it a name and set the desired radius (in this case length of the radius does not matter):

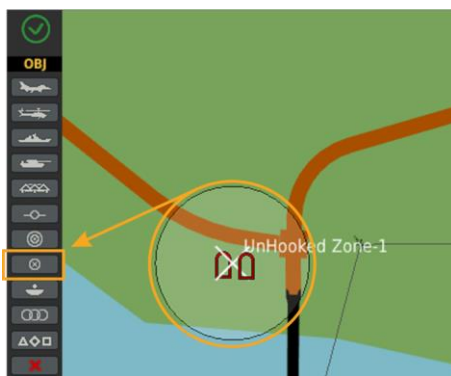

2. In the "TRIGGERS" tab [Fig. 13.6](#) (1) create a new trigger (2); select from the drop-down list the CARGO UNHOOKED IN ZONE (3) condition; select cargo, which must be unhooked at this zone (4) and link the selected cargo with the unhook zone (5):

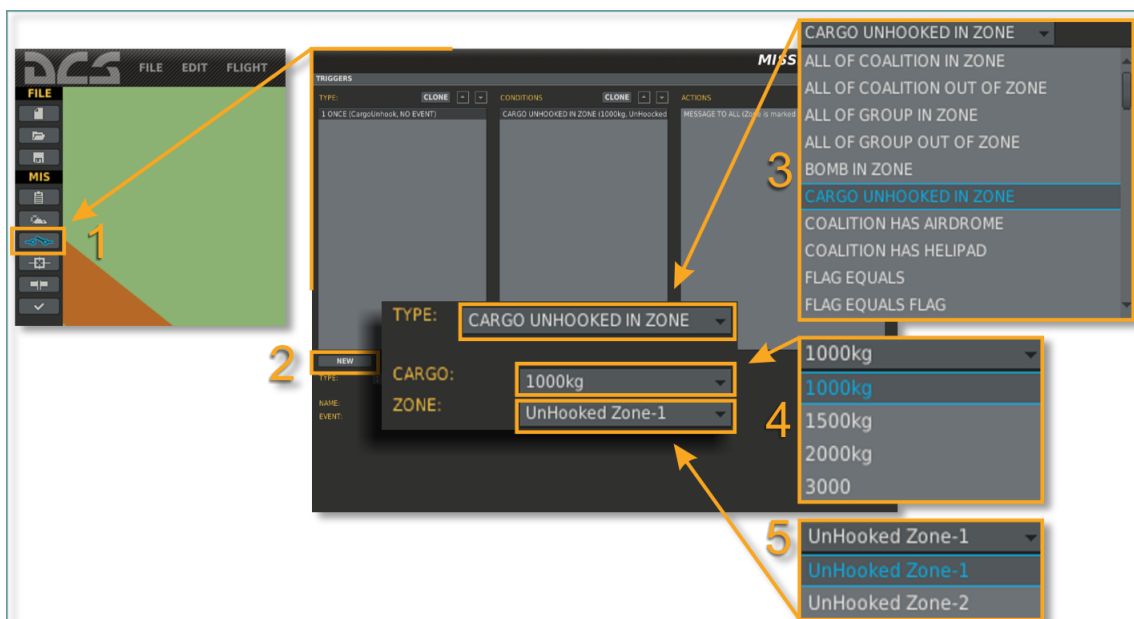

Fig. 13.6. Creation of the unhook zone

3. In the action tab, player must select some actions to be performed when cargo is unhooked, for example, give a message "Cargo is unhooked at designated area". In the opposite case the trigger will not be saved.

Now, while approaching drop zone with a "1000kg" cargo, at a distance of less than 2 km from center of the "UnHooked Zone-1", unhook area will be marked with the smoke and from 50m the AI crew chief, will be giving guiding commands to achieve precise hover over the unhook place. Many different cargos can be linked to one trigger zone.

### **13.1.3. Playing with sling loads**

Let us give you an example, showing selection of a load and various flight stages.

In certain area are several loads with different weight. Player must select one of them, hover over the selected load to hook it up, take off with the sling load, fly to designated area, approach drop zone and hover to unhook the load.

#### *PLAYERS ACTIONS*

##### ***Cargo selection***

To give player an opportunity to select cargo (using radio menu), "cargo visibility zone" is implemented. This zone is moving together with helicopter, flown by player or bot (zone is shown as circles around helicopters №1 and 2). Therefore, cargos can be selected by player only if helicopter is close enough to them, so that distance to a cargo is less than the "cargo visibility zone" (see, [Fig. 13.7](#), helicopter №2)

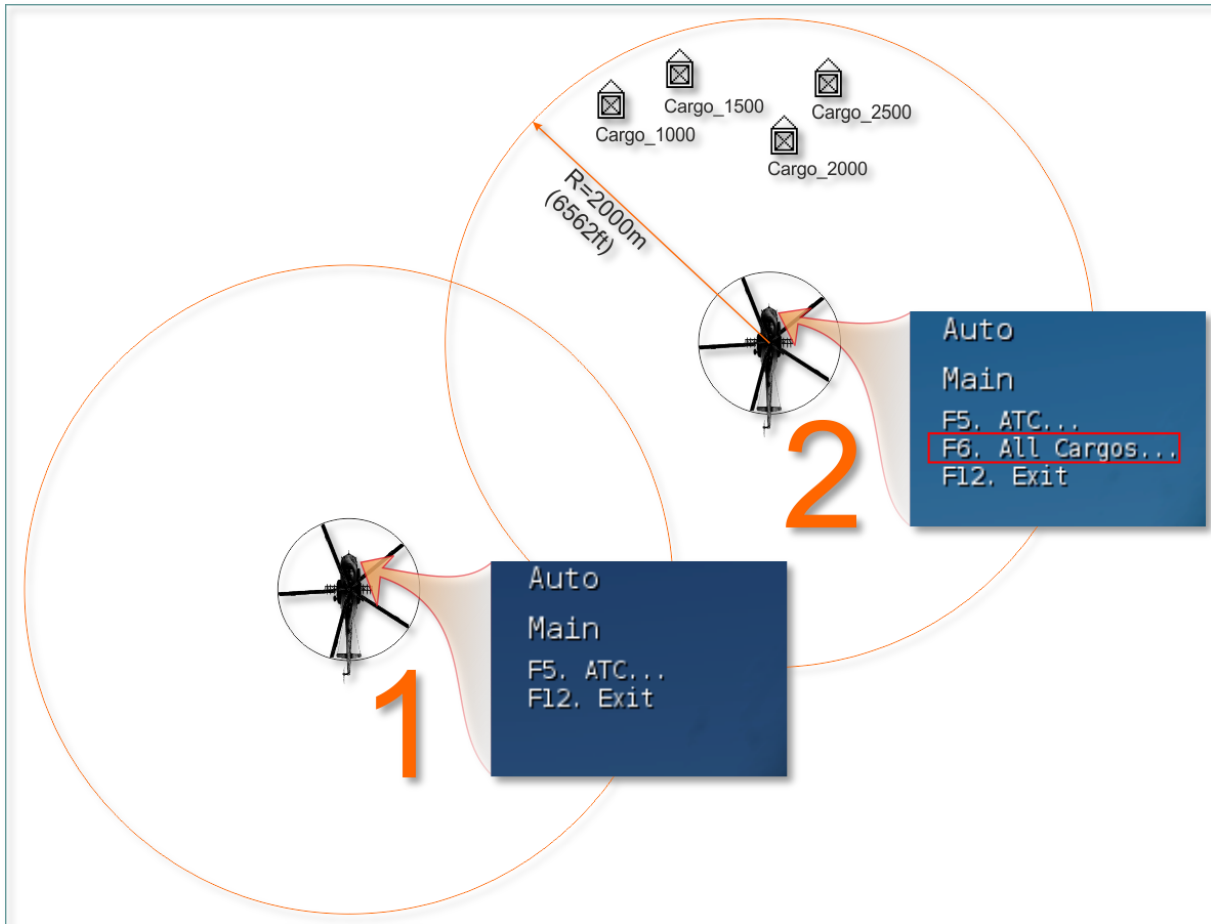

**Fig. 13.7. Explanation of how cargos appear in the radio menu**

Based on experimental results, radius of the cargo detection zone is set to 2000 m (6,562 ft). If helicopter is more than 2000 m. from the cargo, it cannot be selected (helicopter №1). As soon as cargo is in the “visibility zone”, which is moving together with the helicopter, then in radio menu additional entry for cargo selection page, activated by **[F6]**, will appear (helicopter №2).

When cargos are in detection zone, player can select the desired cargo from the list (see, [Fig. 12.9](#)).

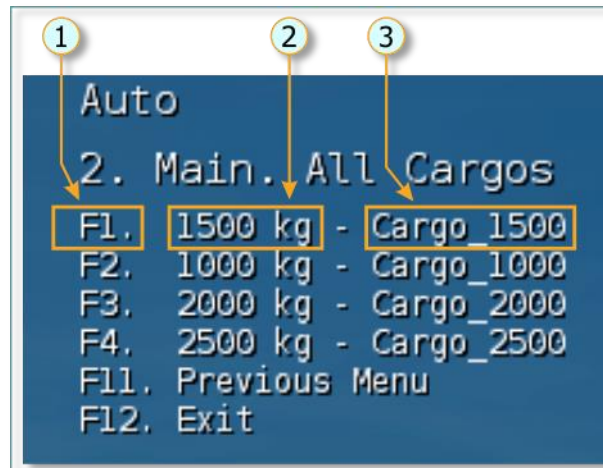

**Fig. 13.8. Cargo selection list**

1. Key, selecting corresponding cargo                      3. Cargo name  
2. Cargo weight

To select desired cargo player must press one of the **[F1..F10]** keys. As a result, cargo location will be immediately marked with a smoke.

If necessary, player can change selected cargo, to do that, one must activate radio menu, select the cargo selection page **[F6]** and choose CANCEL for previously selected cargo. Then the cargo selection procedure, explained above, must be repeated for a new cargo.

### ***Hovering and hooking up the load***

A cargo can be hooked up by the AI (i.e. automatically) or by the player in "manual hook up" mode.

*AUTOMATIC CARGO HOOKUP* is activated once cargo is selected using radio menu. It can be done only by hovering above the cargo. Automatic hookup can only be successful if the following conditions, such as, sling length, precision of hover and time that is required by a virtual ground operator for hooking up the cargo, are fulfilled. Therefore, to hook up the cargo, pilot must hover within limited area and remain there within given period of time. Hover zone limitations:

- relative to longitudinal and lateral axes – radius 2.5m;
- relative to vertical axis – from "load height + 0.5m" to "sling length + load height – 0.5 m". For example, if sling length is 30 m, and load height is 7m, than allowed altitude range (above ground level) for hooking up the cargo is: from 7+0.5m (7.5 m) to 30+7–0.5 (36.5 m).

Helicopter must hover in this zone for not less than 5 s.

Sling length can be from 5 m to 30 m.

When cargo is selected, the external cargo indicator can be activated **[Rshift + RCtrl + P]**.



At a distance of 10 m to selected cargo (any axis) automatic voice assistant is engaged.

While helicopter is hovering precisely over the cargo (all conditions are fulfilled), the IN POSITION/ HOVER ABOVE CARGO message is being shown and after 5 s the LOAD IS HOOKED/ CARGO HOOKED appears. If player leaves required zone, the corresponding message will be given.

"*MANUAL CARGO HOOKUP*". Used if player has landed nearby the load, selected from the menu. "Manual hookup" works only if helicopter is close enough to the selected load and if sling length is longer than the distance from landing place to load attachment point, to hook up press the **[RCtrl + Rshift + L]**. Successful hookup is confirmed by the text message and by voice assistant.

### ***Take off with a sling load***

When the cargo was hooked up, one must, gradually, without rush, increase altitude to tighten up the sling. When the sling is tighten, raise the collective and vertically lift the cargo off the ground. Further, continue climbing and do not go back to hover (do not lower the collective), instead, gradually begin accelerating the helicopter, continuing climbing. Push the stick forward very carefully, exceeding of pitch of more than 1–2° is not recommended. During take off the voice assistant is continuing operating.

While accelerating, do not allow reduction of vertical speed to less than zero. Take into account additional altitude slack, while flying over obstacles.

### ***Flight to designated area (drop zone)***

While flying, monitor if cargo is swinging, and if cargo is swinging heavily, try to compensate swinging by slightly lowering the collective when cargo begins moving from one of the end positions to the center. Avoid sharp and abrupt movements of the stick and collective for changing flying mode. When cargo is swinging or cargo is less than 60 m above the ground, player will be informed by the voice assistant.

### ***Approach and hover over the drop zone, cargo unhook***

Approach the designated drop zone. Reduce speed in advance (1,600- 1,400m), deceleration rate should be significantly lower than under normal conditions, without sling load.

If the drop zone was created with a trigger, then when helicopter approaches drop zone with a sling load, from distance of 2 km drop zone will be marked with a smoke. From 50 m to this zone, voice assistant begins guiding you to help achieving perfect hover and will inform you when the load touches the ground.

Before unhooking the cargo, the "auto unhook" feature (see [Automatic cargo unhook](#)) can be activated, by pressing the **[RCtrl + Rshift + K]**. It will immediately unhook the load, as soon as it touches the ground. Player can unhook load manually as well. When cargo is at desired place on the ground, press the external cargo tactical unhook button or external cargo emergency unhook button, located on the

collective (Fig. 7.43) by pressing the **[RCtrl + Rshift + Ralt + L]** or **[RCtrl + Rshift + Ralt + P]**.

When cargo hook is opened, the corresponding message is given.

### 13.1.4. Informational help to player, related to sling load operations

During playing the game, player can get some hints, which remind player about useful key combinations, rope length, and which cargo is chosen and hooked up. Player must open kneboard to see these hints,

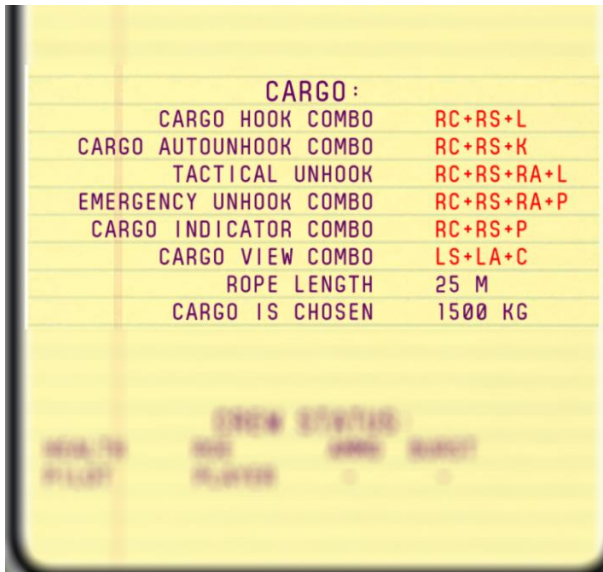

**[Rshift + K]**.

More about kneboard features you can find in chapter [14.7](#).

### 13.1.5. Keyboard commands, related to sling operations

Key combination	Назначение на русском	Function	Comments
<b>[RCtrl + Rshift + P]</b>	Индикатор груза	External Cargo Indicator	Enables/disables external cargo indicator (cheat)
<b>[RCtrl + Rshift + L]</b>	Подцеп груза	External Cargo Hook	When pressed, hooks up the load, if the helicopter is on the ground and sling length is long enough to reach load's attachment point.
<b>[RCtrl + Rshift + Ralt + L]</b>	Тактический отцеп груза	External Cargo Tactical Unhook	Safety cover opens immediately
<b>[RCtrl + Rshift + Ralt + P]</b>	Аварийный отцеп груза	External Cargo Emergency Unhook	Safety cover opens immediately
<b>[RCtrl + Rshift + K]</b>	Автоматический отцеп груза	External Cargo Autounhook Switch – ON/OFF	Activate/deactivate autounhook feature, load is unhooked if cargo touches the ground and force, applied to cargo hook is removed
<b>[RCtrl + Rshift + Ralt + T]</b>	Открытие/закрытие	External Cargo Tactical Unhook	

	колпачка для кнопки "Тактический сброс груза"	Button Cover OPEN/CLOSE	
<b>R</b> Ctrl + Rshift + Ralt + R	Открытие/закрытие колпачка для кнопки "Аварийный сброс груза"	External Cargo Emergency Unhook Button Cover - OPEN/CLOSE	
<b>R</b> Ctrl + Rshift + Ralt + Q	Тактический отцеп груза	External Cargo Tactical Unhook Button	Triggers only if safety cover is opened
<b>R</b> Ctrl + Rshift + Ralt + A	Аварийный отцеп груза	External Cargo Emergency Unhook Button	Triggers only if safety cover is opened
<b>L</b> shift + Lalt + C	Взгляд на цель	View to Aim	Slowly changes normal view to view to the open blister, works differently for pilot's and co-pilot's places.





14

*HOW TO PLAY*

## 14. HOW TO PLAY

### [To Important notice](#)

#### **14.1. General information**

This game is a first-person aircraft simulation, where the player controls an helicopter and interacts with cockpit objects with the help of various game controllers (joysticks, pedals, touchpads, etc.), keyboard and mouse.

It is possible to set an external camera (relative to the helicopter's cockpit) in any place of the game world to observe the player's helicopter and other objects in the world.

The simulation gives the player the unique opportunity to control an helicopter in real-time in the same way a real pilot does. The player has to interact with cockpit objects, distribute his/her attention between the cockpit and the outside world at every stage of the flight – from engine startup to taxiing to the parking spot after landing. In addition, there are scenarios where the player has to interact with and give orders to wingmen (player's squadron pilots).

The game can be played in single-player mode (the player is alone in the simulated world, everything else is controlled by the AI) or in multiplayer mode (there are several human players connected via the internet, other objects are controlled by the AI).

When a module is purchased, it has to be installed and activated as a module to DCS World. The main documents, describing the activation procedure, the main window functions, game settings, mission editor, and the setup of game controllers are located in the "Doc" folder inside the game installation directory. Each document describes a certain game functionality:

- a) how to install and activate the game –  
DCS World Activation Guide EN.pdf;
- b) the main game window and mission editor functionality –  
DCS User Manual EN.pdf;
- c) setup of game controllers –  
DCS World Input Controller Walk Through EN.pdf;
- d) Airfields radio equipment and beacons –  
DCS World List of all available Beacons EN.pdf.

For a player to find himself in the cockpit it is necessary to start relevant mission (scenario) under control of the DCS World shell. Missions can be built-in in the game (supplied with the module installation package), downloaded from the internet or developed independently. A set of related missions is called a campaign. The user can create a mission (campaign) by himself, using the MISSION EDITOR (ME) tools. Usage of the mission editor is described in the document DCS User Manual EN.pdf.

#### ***Interaction between player and virtual cockpit***

Inside the cockpit, the player can **control the aircraft, cockpit objects** and **virtual pilot head position** (views). All these functions can be implemented by



means of keyboard only, mouse, joystick or by their various combinations. It is recommended to use a joystick for controlling the aircraft for the best possible game experience.

The mouse can be used in the following two modes:

- control various objects in the clickable cockpit;
- control virtual pilot head position (view control, "mouse view").

The player can switch between these two modes at any time by pressing the keyboard combination **[Lalt+C]** or by a double-click of the mouse wheel.

## 14.2. Built-in missions

The game comes with a set of built-in missions: training missions, ordinary missions and a campaign. Non-training missions (e.g. campaign) usually assume that the player is already familiar with the helicopter and willing to try a scenario on his own.

### *Procedure for built-in mission start:*

1. Start DCS World. When in the main menu, one can either start a training mission by selecting TRAINING or ordinary missions by selecting INSTANT ACTION or MISSION:

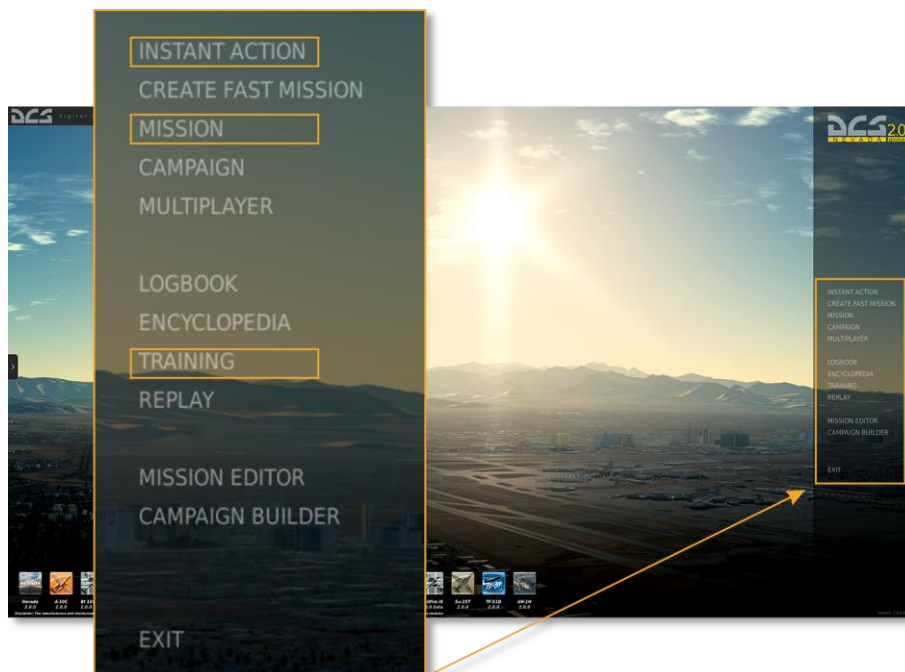

2. To choose a mission, it is necessary to select the desired module on the left and then pick a mission from the corresponding folder (the example below contains the folders "Taining", "QuickStart" and "Single"):

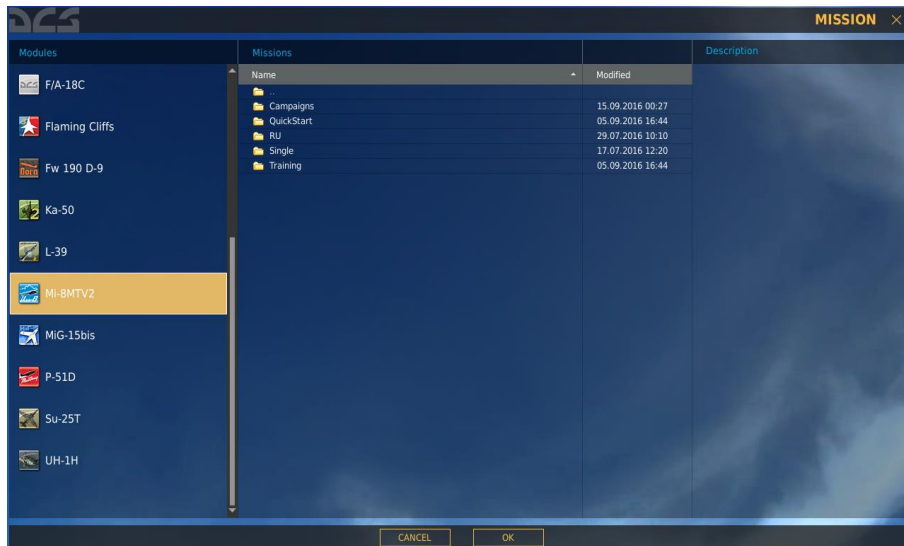

3. When the mission is selected, a briefing window with a START button, which is used to start the mission, appears on the screen:

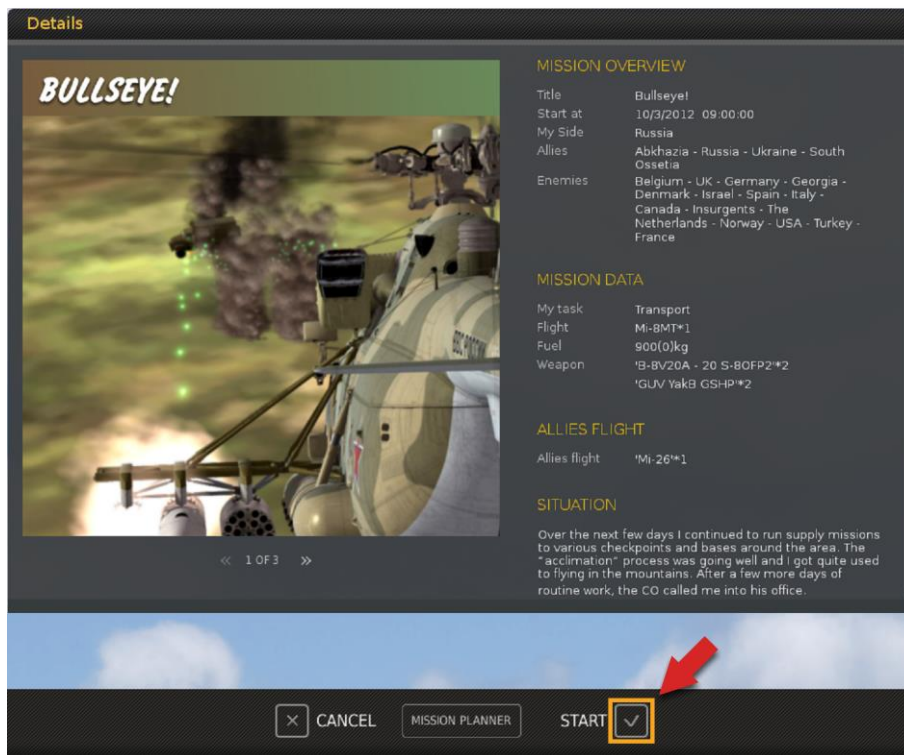

### 14.3. Controlling the helicopter and interacting with cockpit objects in the game

The most essential helicopter's controls include the **aircraft control stick** (for helicopters it is a cyclic stick, for aircraft it is aircraft control stick), **power control lever** (for helicopter it is a collective, which controls main rotor pitch and engines, for airplane it is a throttle) and **pedals**. Cyclic (control stick) is used to control roll (roll to the left or right) during turns, and pitch (nose up, nose down) during ascend or descend, or in case of helicopter, to accelerate or decelerate helicopter. Collective

(throttle) is used when it is necessary to increase or decrease horizontal or vertical speed. Pedals control yaw axis (turn of the plane nose to the right or left) and to compensate slides with help of the rudder. Besides that, on the planes they can be used, during taxiing, for braking main wheels separately to turn in the desired direction (simultaneously with rudder deflection).

### 14.3.1. Controlling aircraft (airplane or helicopter) with help of a joystick



Roll

Pitch

Some joysticks are equipped with some lever or/and rotating knob (it can be any axis of the joystick), which controls throttle (collective for helicopter) and a twister for controlling pedals.

While piloting, it is possible to enable the controls indicator, using the **[RCtrl+Enter]**



to see current positions of helicopter's controls

### 14.3.2. Controlling helicopter with keyboard

If the player controls the helicopter using only the keyboard, the main control buttons are: **arrow keys** to control cyclic (roll and pitch), **[Numpad+]** or **[Numpad-]** for collective control and **[Z]** or **[X]** keys for pedals:

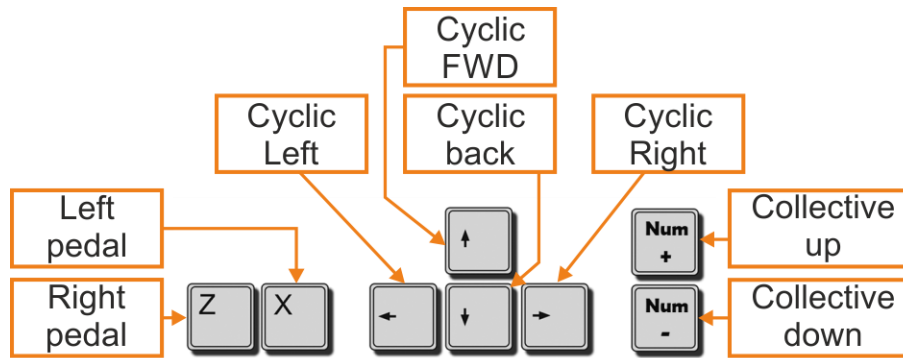

### 14.3.3. Interacting with cabin objects with the mouse

All objects of the clickable cockpit can be controlled by the mouse. This is the main mouse mode in the game. The left and right buttons and the mouse wheel can be used.

Normally, all switches are enabled by the left mouse button. The rotary switches (rotating knobs with fixed positions) rotate with the left mouse button in one direction and with the right one in the other. Cockpit objects, which can be enabled or disabled with the mouse (when the mouse pointer is over them), are marked with the following symbol:



Rotating knobs can be rotated with the mouse wheel. The cockpit objects, which can be rotated when the mouse pointer is over them, are marked with the following symbol:



To speed up the rotation of the knobs using the mouse wheel, it is necessary to press **[Lshift]** while rotating the mouse wheel. This way the knob will rotate 10 times faster. By default, the mouse is in the "cockpit object control mode" described above.

## 14.4. Controlling virtual pilot head position and views in the 6DOF cockpit

### 14.4.1. Controlling virtual pilot head position in the 6DOF cockpit

This implies that the head can be moved along the three axes (OX, OY, OZ), and rotated around these axes ([Fig. 14.1](#)).

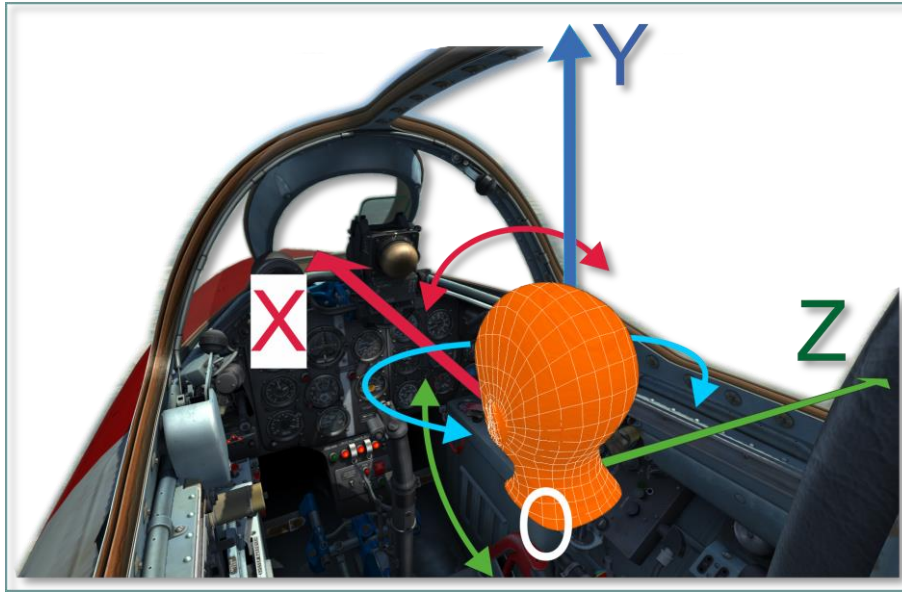

**Fig. 14.1 Axes in the 6DOF cockpit**

Head position may be controlled by all input devices: keyboard, mouse, joystick and head tracking devices such as TrackIR. NOTE that virtual head rotation around the OX axis (red color curved arrow) usually is not used, that is why it is unavailable for controlling by means of keyboard and mouse.

In addition to head movement and rotation, there is also zoom feature (cockpit view angle reduction).

The rate of view moving can be change:

<b>Lshift +  </b>	Mouse Rate Fast
<b>Lalt +  </b>	Mouse Rate Normal
<b>LCtrl +  </b>	Mouse Rate Slow





I.e. the working area of the screen displays only objects, which is inside the field of view. Because the field of view becomes narrow during zooming, objects within the same area become larger. This can be compared with the use of a telescope: all objects, located along the line of sight, are visible at any magnification.

***Head movement, rotation and image zooming with keyboard and mouse***









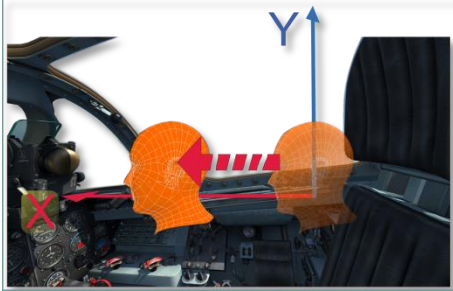

Symbols on schematics showing the mouse usage:

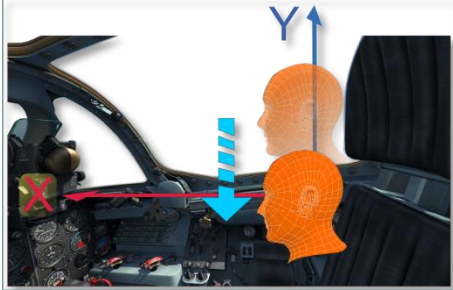



	Click and hold the wheel pressed
	Wheel double click

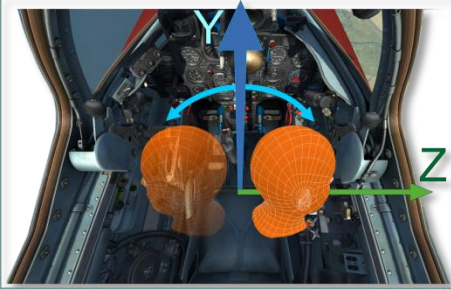
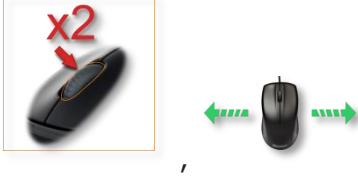
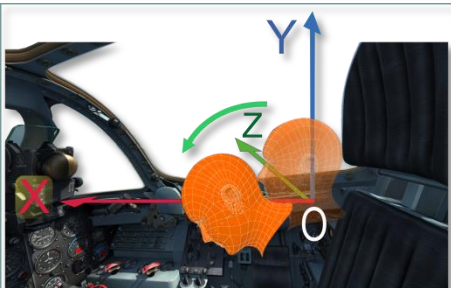

	Click, hold the wheel pressed and rotate it
	Rotate mouse wheel
	Head movement along the corresponding axis
	Head rotation around the corresponding axis

By default, the mouse is in *COCKPIT OBJECT CONTROL MODE*. To switch it in *VIRTUAL PILOT HEAD POSITION CONTROL MODE* (and back), it is necessary to use the key combination **[Lalt+C]** or **perform a double click of the mouse wheel**.

Action	Implementation by keyboard and mouse
	Implementation by keyboard and mouse With keyboard: <b>[RCtrl+Rshift+*]</b> or <b>[RCtrl+Rshift+ /]</b> With mouse:  
	With keyboard: <b>[RCtrl+Rshift+Num2]</b> or <b>[RCtrl+Rshift+Num8]</b> With mouse:   and 
	With keyboard: <b>[RCtrl+Rshift+Num4]</b> or <b>[RCtrl+Rshift+Num6]</b> With mouse:   and 

	<p>With keyboard: [Num4] or [Num6]</p> <p>With mouse:</p> 
	<p>With keyboard: [Num2] or [Num8]</p> <p>With mouse:</p> 
	<p><i>ZOOM</i></p> <p>With keyboard: [Num*] or [Num/]</p> <p>With mouse:</p> 

#### 14.4.2. Controlling views in the 6DOF cockpit

Many cockpit objects are located inconveniently (in niches, covered by other objects). To be able to quickly look at the correct object in flight and return to the instrument panel, the built-in **SnapView** function can be used using key combinations. This function "remembers" custom views created by the player and allocates corresponding key combinations on the numeric keyboard. After recording, they can be used with the key combination [Num0] (modifier) + [Num1..9] (one of 9 needed views)].

Before creating individual custom views, the player is encouraged to review the pre-defined default views by pressing [Num0+Num1..9] in succession. In many cases, the default views are sufficient for the player's needs.

To create a custom SnapView, it is necessary to:

- a) activate saving of one of the views by pressing **[Num0+Num1..9]** (only one number), start of the saving is activated;

NOTE. View adjustments can be done with standard keyboard commands for controlling the camera:

- **[Num \*]** – zoom in slow, **[Num /]** – zoom out slow,
- **[Rshift+RCtrl+Num2]** – cockpit camera move DOWN,
- **[Rshift+RCtrl+Num8]** – cockpit camera move up,
- **[Rshift+RCtrl+Num4]** – cockpit camera move left,
- **[Rshift+RCtrl+ Num6]** – cockpit camera move right,
- **[Num1..9]** – rotation of the current point of view,
- **[Num5]** – center view,
- **[Rshift+RCtrl+ Num\*]** – cockpit camera move forward,
- **[Rshift+RCtrl+ Num/]** – cockpit camera move back.

- b) set up the view as needed (for example – PKV Sight a custom SnapView), for this is necessary to perform the following steps:

- (1) move the camera to the center of the selected object **[Rshift+RCtrl+Num2,8,6,4]**;
- (2) turn the sight axis to the desired angle **[Num2,8,6,4]**;
- (3) zoom to the object at the desired distance: zoom in **[\*]** or zoom out **[/]**, for result as [Fig. 14.2](#):



**Fig. 14.2. The custom SnapView of PKV Sight**

- (4) finish storing the adjusted views to a file by pressing the key combination **[Ralt + Num0+Num1..9]**.

Information about custom views is stored in the file

"C:\Users\<<USERNAME>\Saved Games\DCS\Config\View\SnapViews.lua".

## 14.5. Special settings of the module

Special settings of the module are located on the SPECIAL tab, [Fig. 14.3](#):

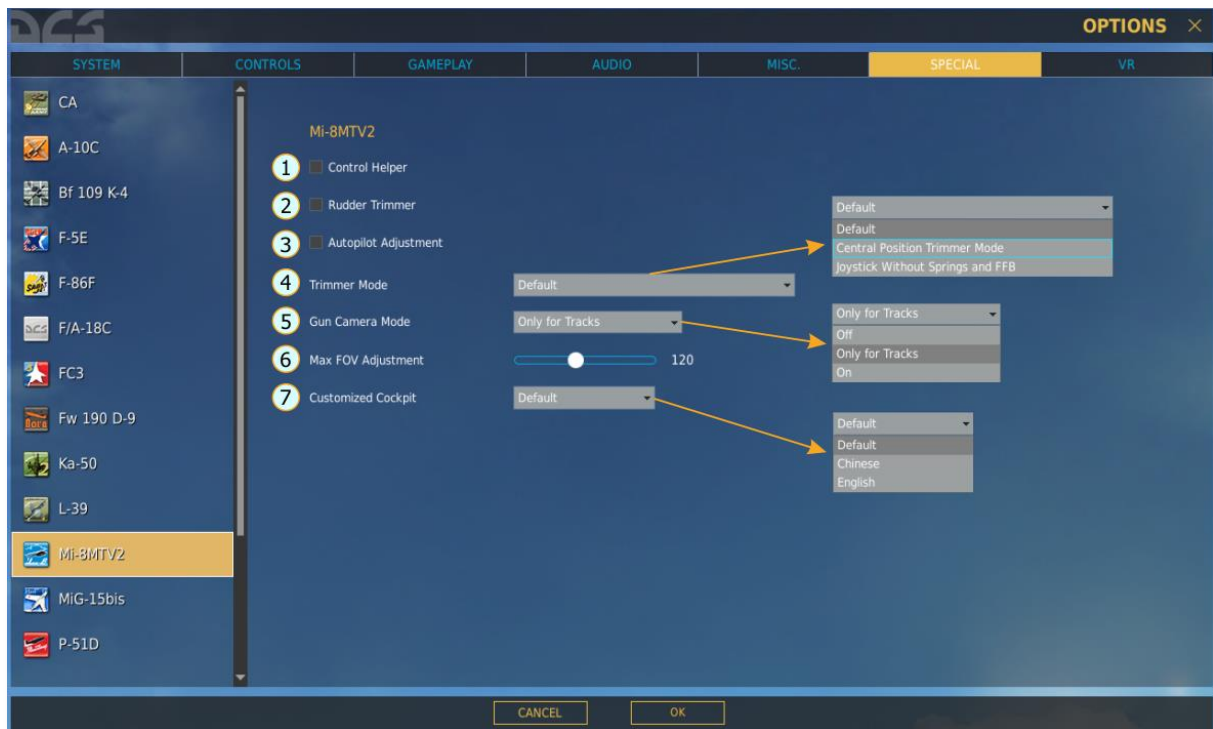

**Fig. 14.3. Special settings of the DCS: Mi-8MTV2**

- |                                    |  |
|------------------------------------|--|
| 1. CONTROL HELPER (checkbox)       | 5. GUN CAMERA MODE (droplist)                          |
| 2. RUDDER TRIMMER (checkbox)       | 6. MAX FOV ADJUSTMENT (slider)                         |
| 3. AUTOPILOT ADJUSTMENT (checkbox) | 7. CUSTOMIZED COCKPIT, language and texture (droplist) |
| 4. TRIMMER MODE (droplist)         |  |

(1) *CONTROL HELPER*. Activates control helper, if checkbox is checked (). In this case helper will smoothify abrupt and high-amplitude deflections of the cyclic, try to prevent rapid roll, pitch and yaw changes, compensate reactive moment of the tail rotor. Can be useful to new beginners.

(2) *RUDDER TRIMMER*. If checked, then when the trimmer button  is pressed, pedals will be trimmed simultaneously with cyclic, i.e. pedals in model will retain their position, even if player returned them to neutral position (due to springs in pedals). Works in the same way as for joystick with "Central position trimmer mode" option selected (see below).

(3) *AUTOPILOT ADJUSTMENT*. If this checkbox is checked, then AI crew chief constantly (automatically) "adjust" roll and pitch channels by the centering knobs, if deviations of the indicators are more than 50% of travel range. Adjustment is performed at a slow rate (not more than 1 degree/sec), therefore player does not feel anything.

**N O T E .** It is possible to adjust autopilot without having this box checked using the **[Ralt + A]** command. In this case AI crew chief will adjust roll and pitch channels only once and report about actions taken

(4) *TRIMMER MODE.* It is a droplist with the following entries:

- "Default" – joystick works in a normal way: pressing the trimmer button **[T]** only makes trimmer sound, position of the cyclic is equal to the joystick's position.
- "Central position trimmer mode" – after pressing the trimmer button, the cyclic remains in the same position, where it was at this moment, and the following changes in joystick's position have no impact on cyclic, until player return his joystick to the center position (with some margin). After that deflection of the joystick will be added to the current position of cyclic (latest trimmed position). To reset cyclic trimmer, player must use the **[LCtrl + T]** command;
- "Joystick without springs and FFB " – is intended to be used with customly modified joysticks, which have centering springs removed. In this case, when the trimmer button is pressed, the click of the trimmer is heard and the actual position of the joystick is equal to the position of the virtual cyclic in the model.

(5) *GUN CAMERA MODE.* Droplist with the following entries: OFF, Only for tracks, ON. It specifies the usage of the AKS-2 gun camera.

(6) *MAX FOV ADJUSTMENT.* This slider sets the initial field of view, when mission is loaded. Default value is  $-120^{\circ}$ . The most adequate angular sizes of the cockpit objects are achieved with FOV equal to  $90^{\circ}$ .

(7) *CUSTOMIZED COCKPIT.* It is a droplist with the following entries:

- "Default" – language of the cockpit labels is selected based on language settings of the operating system (Russian or English);
- "English" – all labels will be on English language;
- "Chinese" – all labels will be on Chinese language.

## **14.6. Additional properties of the aircraft in the DCS:MI-8MTV2**

The DCS Mission Editor includes a number of special "tuning" options for the Mi-8MTV2 helicopter ([Fig. 14.4](#)). In addition to the standard air group settings of the ME, the following special properties are available for the Mi-8MTV2:

- remove/install external hardpoints and PKV gunsight;
- sets the rope length for slingload operations (see, [13.1.2](#), [7](#)).
- remove/install exhaust IR suppression devices;
- remaining service life of engines;
- remove/install additional armor;
- remove/install cargo bay doors;



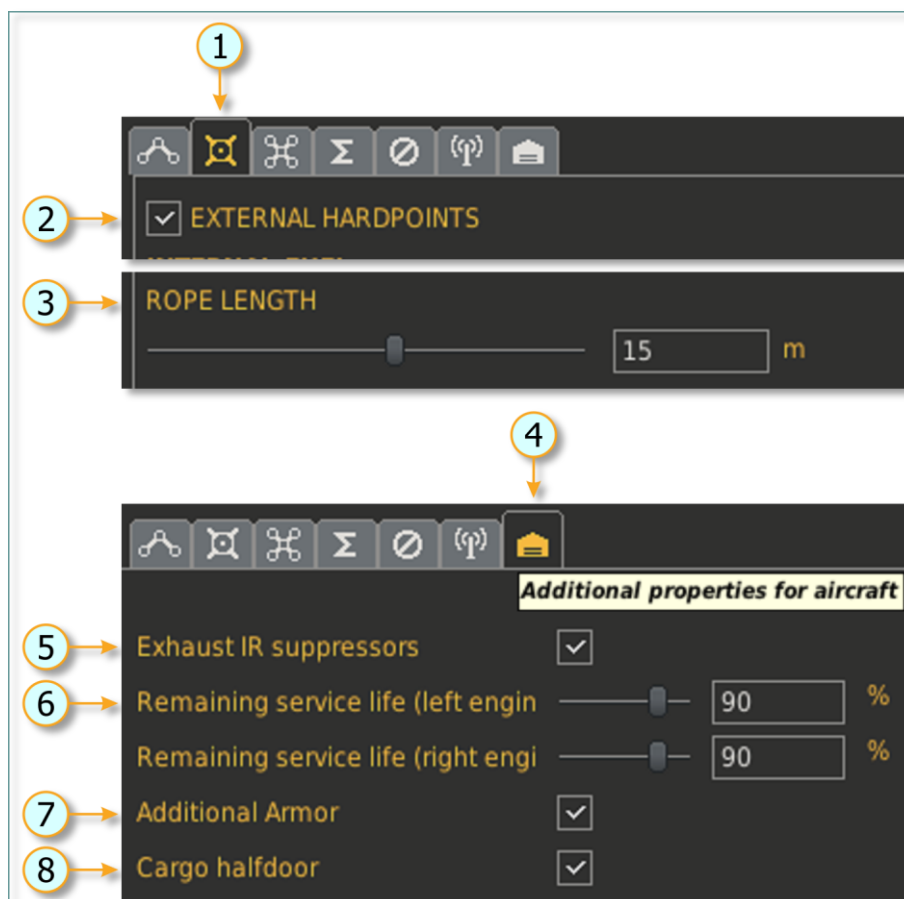

**Fig. 14.4. Additional properties of the aircraft in the DCS:MI-8MTV2**

1. Activates payload tab
2. Installs external hardpoints
3. Sets the rope length in m. for sling load operations
4. Activates the additional properties of the aircraft tab
5. Install exhaust IR suppression devices
6. Sets remaining service life of the engines
7. Installs additional armor
8. Installs cargo bay doors

(2) *THE EXTERNAL HARDPOINTS* checkbox is checked – enables attachment of all available weapon on external hardpoints and increases weight of empty helicopter by 401 kg.

(3) *SET THE LENGTH ROPE* for transporting external cargo

(5) *INSTALLS EXHAUST IR SUPPRESSION DEVICES* (7.12). It decreases engines' IR signature by approximately two times. This reduces lock on range for IR SAMs and increases probability of successful flight through SAM protected areas.

(6) *ENGINES' SERVICE LIFE COEFFICIENT* allows creating missions, in which helicopter's power plant will be worn out, which, in its order, requires additional skills of the player, when performing designated task.

NOTE: 90% corresponds to new engine from the manufacturing plant.

100% is a testing stand power (conditionally)

This coefficient is non-linear, therefore:

- 75% - main rotor RPM drops at collective of 11,5°.

- 50% - main rotor RPM drops at collective of 5°. It is not possible to fly using these engines.

(7) *ADDITIONAL ARMOR* checkbox – additional armor increases survivability of crew and important helicopter's units from bullets and fragments. Increases empty weight of helicopter by 419 kg.

(8) *INSTALLS OR REMOVES CARGO BAY DOORS* – removed cargo bay doors increase amount of different game variations and decrease helicopter's weight by 130 kg.

### **14.7. Kneeboard**

To ease the learning process and also to compensate "flight in front of the monitor" inconveniences, kneeboard are available in the game. It contains information about current states of important parameters of the equipment, AI-gunners state and some useful key combinations for changing, mentioned above parameters, [Fig. 14.5](#):

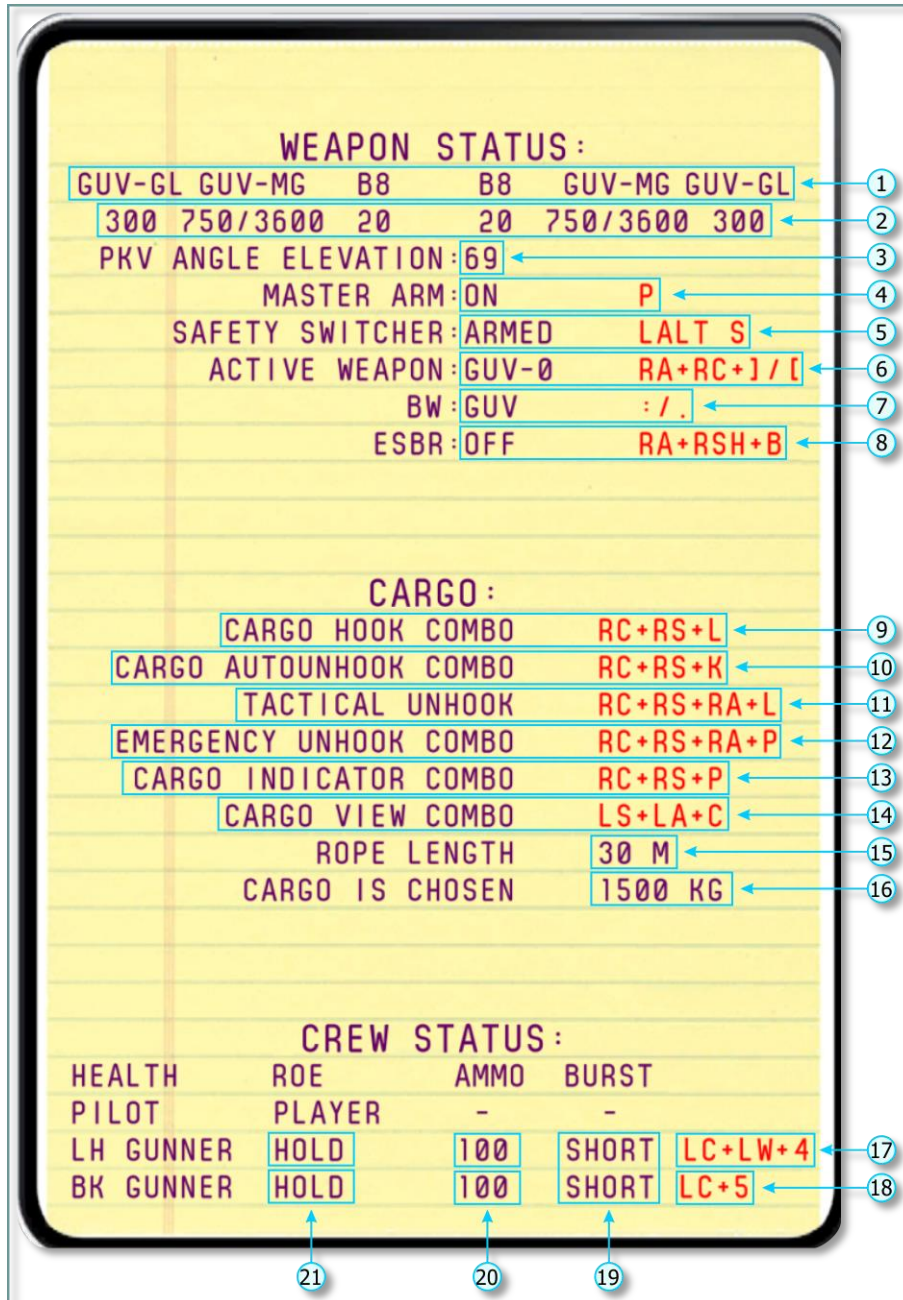

**Fig. 14.5. Kneboard**

**WEAPON**

- 21. Indication of weapon on hardpoints:
  - GUV-GL – GUV grenade launcher
  - GUV-MG – GUV machine gun
  - UPK – UPK-23-250
  - B8 – B8V20 rockets
  - Bo – bombs
- 2. Remaining ammo (for GUV-MG in numerator for 12.7-mm machine guns, in denominator for 7.62-mm machine guns)
- 3. PKV elevation angle
- 4. Position of master arm (ГВ) on the left circuit breaker console and key command for enabling or

**CARGO OPERATIONS**

- 9. Key command for manual cargo hooking.
- 10. Key command, activating autounhook feature, when cargo is unhooked once it touches the ground.
- 11. Key command for tactical unhook of the cargo in the air
- 12. Key command for emergency unhook of the cargo in the air
- 13. Key command activating cargo indicator
- 14. Key command activating view on cargo from the blister/ return back to normal view
- 15. Rope length, selected in ME.

disabling master arm.

5. Safety switcher position (ARMED, SAFE) and a key command for toggling it.

6. Active weapon selection (RS – rockets, UPK, PKT, GUV ) and key combinations for changing active weapon (RC=RCtrl, RA=Ralt, R=Rshift)

7. Position of the rotation switch on the copilot's weapons control panel (I, II, III, IV, V, GUV) and corresponding key commands.

8. Position of the ESBR-3P electrical release control box (ON, OFF) and key commands.

16. Weight of chosen or hooked cargo

#### CREW STATUS

17. Key command, changing ROE setting for the door gunner (HOLD, RET.FIRE, FIRE)

18. Key command, changing ROE setting for the tail gunner (HOLD, RET.FIRE, FIRE)

19. Burst length of AI-gunners (can not be changed)

20. Remaining ammo, in percents of total ammo.

21. Indication of ROE settings for the AI-gunners

The kneboard is activated by pressing **[K]** (shown only while the key is kept pressed) or **[Rshift + K]** (toggle mode, i.e. switched on/off by the same key combination).

### 14.8. Use of AI crew members assistance

In the game, AI can perform several functions:

- autopilot adjustment by the AI crew chief;
- voice assistance by the AI crew chief (automatic voice assistant) while playing with sling loads, which helps positioning the helicopter precisely over the cargo for hooking it, or over drop zone, for unhooking it.

#### 14.8.1. Autopilot adjustment by the AI crew chief

It can be done by the player request or automatically.

Command from the player is **[Ralt + A]**. After activation, the AI crew chief smoothly adjust roll and pitch channels, using corresponding centering knobs, all actions he performs are commented by voice.

For automatic adjustment, one must check the corresponding checkbox in the special tab of the module settings:

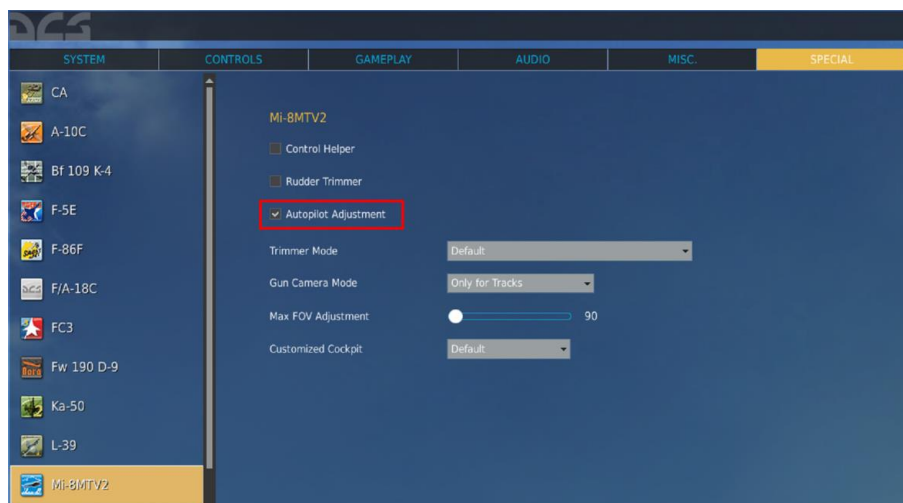

### **14.8.2. Commands, given by the AI crew chief, while playing with sling loads**

This commands are given by the AI crew chief during hovering over the cargo for unhooking it, during lifting off the cargo and unhooking the cargo. Refer to [Table 13.1](#) and chapter [13.1.1](#) for detailed explanation of this feature.





**15**

***ABBREVIATIONS & TERMS***

## 15. ABBREVIATIONS & TERMS

%Q	Percent Torque
AC	Alternating Current
ACB	Automatic Circuit Breaker
ADF	Automatic Direction Finder
AGL	Above Ground Level
Ah	Amper x hour
AI	Artificial intelligence
ALT	Alternator
ALT	Altitude/Altimeter
ALTM	Altimeter
AM	Amplitude Modulation
AMP	Ampere
ANT	Antenna
APU	Auxiliary power unit
ATTD	Attitude
AUTO	Automatic
AUX	Auxiliary
AVGAS	Aviation Gasoline
BAT	Battery
BDHI	Bearing Distance Heading Indicator
BFO	Beat Frequency Oscillator
BL	Butt Line
BRIL	Brilliance
BRT	Bright
C	Celsius
CARR	Carrier
CAS	Calibrated Airspeed
CCW	Counter Clockwise
CDI	Course Deviation Indicator
CG	Center of Gravity
CL	Centerline
CMPS	Compass
CNVTR	Converter
COLL	Collision
COMM	Communication
COMPT	Compartment
CONT	Continuous
CONT	Control
CONV	Converter
CW	Clockwise
DC	Direct Current
DCP	Dispenser Control Panel
DECR	Decrease
deg	degree

DET	Detector
DF	Direction Finding
DG	Directional Gyro
DIS	Disable
DISS	
DISP	Dispense
DPD	Dust protection devices (the same as PSS)
DSCRM	Discriminator
ECL	Engine Condition Levers ("ППУД" in RU)
ECM	Electronic Countermeasures
EGS	Exhaust Gas Suppressor
EGT	Exhaust Gas Temperature
ELEC	Electrical
EMER	Emergency
END	Endurance
ENG	Engine
ESS	Essential
EXH	Exhaust
EXT	Extend
EXT	Exterior
F	Fahrenheit
FAT	Free Air Temperature
FCU	Fuel Control Unit
FITG	Fitting
FM	Frequency Modulation
FOD	Foreign Object Damage
ftm	feet per minutes
FPS	Feet Per Second, or Frame Per Second
FREQ	Frequency
FS	Fuselage Station
FT	Foot
ft	feet
FT/MIN	Feet Per Minute
ft-in	feet&inch
FUS	Fuselage
FWD	Forward
G	Guard
G	Gravity
GAL	Gallon
gal	Gallon
GD	Guard
GEN	Generator
GND	Ground
GOV	Governor
GPU	Ground Power Unit
GRWT	Gross Weight
GW	Gross Weight

HDG	Heading
HF	High Frequency
HIT	Health Indicator Test
HTR	Heater
HVAR	High Velocity Aircraft Rocket
HYD	Hydraulic
Hz	Herz
IAS	Indicated Airspeed
ICS	Interphone Control Station
IDENT	Identification
IFF	Identification Friend or Foe
IGE	In Ground Effect
in	Inch
INCR	Increase
IND	Indication/Indicator
INHG	Inches of Mercury
INOP	Inoperative
INST	Instrument
INT	Internal
INT	Interphone
INV	Inverter
INVTR	Inverter
IR	Infrared
IRT	Indicator Receiver Transmitter
ISA	International Standard Atmosphere
KCAS	Knots Calibrated Airspeed
kHz	Kilohertz
KIAS	Knots Indicated Airspeed
km	Kilometer
kN	Kilonewton
knots	Nautical Miles per hour
knots	Nautical Miles per hour
kp	Kilogram-force
KTAS	Knots True Airspeed
kts	Knots
kVA	Kilovolt-Ampere
kW	Kilowatt
L	Left
LABS	Low-altitude bombing system
LB	Pounds
lbf	pound-force
lbs	Pounds
LCM	Left (button) Click Mouse
LDG	Landing
LH	Left Hand
LSB	Lower Sideband
LT	Lights

LTG	Lighting
LTS	Lights
MAG	Magnetic
MAN	Manual
MAX	Maximum
MED	Medium
MHF	Medium-High Frequency
MHz	Megahertz
MIC	Microphone
mil	417illiard, 1\6400 part of a circle
MIN	Minimum
MIN	Minute
MISC	Miscellaneous
mm	Millimeter
MON	Monitor
MPC	Manual pip control
MWO	Modification Work Order
N1	Gas Turbine Speed (Compressor)
N2	Power Turbine Speed (link with Main Rotor)
NAV	Navigation
NET	Network
NM	Nautical Mile
nm	Nautical Mile
NO	Number
NON-ESS	Non-Essential
NON-SEC	Non-Secure
NORM	Normal
NR, Nr	Main Rotor RPM
NVG	Night Vision Goggles
OGE	Out of Ground Effect
PED	Pedestal
PKT	7.62 Mashin Gun
PLT	Pilot
PRESS	Pressure
PRGM	Program
PSI	Pounds Per Square Inch
PSS	Particle Separator System (the same as DPD)
PTIT	Power Turbine Inlet Temperature
PVT	Private
PWR	Power
QTY	Quantity
R	Right
R/C	Rate of Climb
R/D	Rate of Descent
RCM	Right (button) Click Mouse
RCVR	Receiver
RDR	Radar



RDS	Rounds
REL	Release
REM	Remote
RETR	Retract
RETRAN	Retransmission
RF	Radio Frequency
RH	Right Hand
RI	Remote Height Indicator
RKT	Rockets
RPM	Revolutions Per Minute
SAM	Surface to Air Missile
SEC	Secondary
SEC	Secure
SEL	Select
SENS	Sensitivity
SL	Searchlight
SOL	Solenoid
SQ	Squelch
SQFT	Square Feet
SSB	Single Sideband
STA	Station
STBY	Standby
T/R	Transmit-Receive
TAS	True Airspeed
TEMP	Temperature
TGT	Turbine Gas Temperature
TRANS	Transfer
TRANS	Transformer
TRANS	Transmitter
TRQ	Torque
UHF	Ultra-High Frequency
UPK	Gun pods equipped with GSh-23L (ГШ-23Л) twin-barrel 23 mm cannon
USB	Upper Sideband
V	Volt
VAC	Volts, Alternating Current
VDC	Volts, Direct Current
VHF	Very high Frequency
VM	Volt Meter
VNE	Velocity, Never Exceed (Airspeed)
VOL	Volume
VOR	VHF Omni Directional Range
WL	Water line
WPN	Weapon
XCVR	Transceiver
XMIT	Transmit
XMSN	Transmission

XMTR	Transmitter
$\Delta F$	Increment of Equivalent Flat Plate Drag Area

## RU

АВСК	Аппаратура внутренней связи и коммутации
АЗС	Автомат защиты сети
АНО	Аэронавигационные огни
АРК	Автоматический радиокompас
АРП	Автоматический радиопеленгатор
АЦП	Аналогово-цифровой преобразователь
АЭР	Аэродром
БАНО	Бортовые аэронавигационные огни. Красный – левый, зеленый – правый.
БЧ	Боевая часть
БПРМ	Ближняя приводная радиостанция с маркером
БПРС	Ближняя приводная радиостанция (1000 м от торца ВПП)
ВМГ	Винтомоторная группа
ВПП	Взлетно-посадочная полоса
ВС	Воздушное судно
ВСУ	Вспомогательная силовая установка
ГВ	Главный выключатель
ГПК	Гиropолукомпас
ГУВ	Гондола универсальная вертолетная
ДИСС	Доплеровский измеритель составляющих скоростей
ДПРМ	Дальняя приводная радиостанция с маркером
ДПРС	Дальняя приводная радиостанция (4000 м от торца ВПП)
ЗПУ	Заданный путевой угол
ИВС	Истинная воздушная скорость
ИПМ	Исходный пункт маршрута
КМГУ	Контейнер мелких грузов универсальный
КПМ	Конечный пункт маршрута
КУР	Курсовой угол радиостанции
КУЦ	Курсовой угол цели
ЛА	Летательный аппарат
ЛБУ	Линейное боковое уклонение
ЛУР	Линейное упреждение разворота
МВ	Минное вооружение
МК	Магнитный курс
МГР	Магнитный пеленг радиостанции
МСА	Международная стандартная атмосфера

НАР	Неуправляемая авиационная ракета
НВ	Несущий винт
НОП	Наземный обслуживающий персонал
НППУ	Несъемная подвижная пушечная установка
НВР	Неуправляемое ракетное вооружение
ОПРС	Отдельная приводная радиостанция (NDB)
ОПС	Оптическая прицельная система
ОСП	Оборудование системы посадки. Система посадки по дальней и ближней приводным радиостанциям (ICAO 2NDB Approach)
ОТ	Оперативная точка
ОШ	Общий шаг винтов
ПВД	Приемник воздушного давления
ПВО	Противовоздушная оборона
ПВР	Пульт выбора режимов
ПЗУ	Пылезащитное устройство
ПНК	Пилотажно-навигационный комплекс
ПНП	Планово-навигационный прибор
ПОС	Противообледенительная система
ППД	Приемник полного давления
ППМ	Промежуточный пункт маршрута
ППУ	Продольно-поперечное управление (ручка)
ПрПНК	Прицельно-пилотажно-навигационный комплекс
ПРС	Приводная радиостанция
ПТБ	Подвесной топливный бак
ПУ	Путевой угол
ПУИ	Пульт управления и индикации
ПУР	Пульт управления режимами
РОШ	Рычаг общего шага
РППУ	Ручка продольно-поперечного управления
РРУ (РРУД)	Рычаги раздельного управления (двигателями)
РС	Реактивные снаряды
РСНВ	Режим самовращения несущего винта
РУ	Расчетный угол
САР	Система автоматического регулирования
СГФ	Строительная горизонталь фюзеляжа
СПО	Стрелково-пушечное оружие
СПУ	Вертолетное переговорное устройство
СРО	Вертолетный радиолокационный ответчик госопознавания
СТ	Свободная турбина
СУО	Система управления оружием

ТК	Турбокомпрессор
ТТХ	Тактико-технические характеристики
УВД	Управление воздушным движением
ФПУ	Фактический путевой угол
ХС	Хвостовой сигнал. Белого цвета, установлен на киле
ЦАП	Цифро-аналоговый преобразователь
ЦСО	Центральный сигнальный огонь
ШБЖ	Штурманский бортовой журнал
ЭВУ	Экранно-выхлопное устройство
ЭРД	Электронный регулятор двигателя
GPS	Global Positioning System – среднеорбитальная спутниковая радионавигационная система НАВСТАР, разработанная в США
NDB	Nondirectional radio-beacon (отдельная приводная радиостанция ОПРС)
NAVSTAR	- NAVigation Satellites for Timing And Ranging (навигационные спутники для определения времени и расстояний) – название системы GPS в англоговорящих странах, отсюда русское НАВСТАР
VOR	Very-high-frequency omnidirectional range (всенаправленный курсовой радиомаяк УКВ-диапазона)







## 16. THE METRIC SYSTEM AND EQUIVALENTS, CONVERSION FACTORS

### 16.1. *The Metric System and Equivalents*

#### Linear Measure

1 centimeter = 10 millimeters = .39 inch  
 1 decimeter = 10 centimeters = 3.94 inches  
 1 meter = 10 decimeters = 39.37 inches  
 1 dekameter = 10 meters = 32.8 feet  
 1 hectometer = 10 dekameters = 328.08 feet  
 1 kilometer = 10 hectometers = 3,280.8 feet

#### Weights

1 centigram = 10 milligrams = .15 grain  
 1 decigram = 10 centigrams = 1.54 grains  
 1 gram = 10 decigram = .035 ounce  
 1 decagram = 10 grams = .35 ounce  
 1 hectogram = 10 decagrams = 3.52 ounces  
 1 kilogram = 10 hectograms = 2.2 pounds  
 1 quintal = 100 kilograms = 220.46 pounds  
 1 metric ton = 10 quintals = 1.1 short tons

#### Liquid Measure

1 centiliter = 10 milliliters = .34 fl. ounce  
 1 deciliter = 10 centiliters = 3.38 fl. ounces  
 1 liter = 10 deciliters = 33.81 fl. ounces  
 1 dekaliter = 10 liters = 2.64 gallons  
 1 hectoliter = 10 dekaliters = 26.42 gallons  
 1 kiloliter = 10 hectoliters = 264.18 gallons

#### Square Measure

1 sq. centimeter = 100 sq. millimeters = .155 sq. inch  
 1 sq. decimeter = 100 sq. centimeters = 15.5 sq. inches  
 1 sq. meter (centare) = 100 sq. decimeters = 10.76 sq. feet  
 1 sq. dekameter (are) = 100 sq. meters = 1,076.4 sq. feet  
 1 sq. hectometer (hectare) = 100 sq. dekameters = 2.47 acres  
 1 sq. kilometer = 100 sq. hectometers = .386 sq. mile

#### Cubic Measure

1 cu. centimeter = 1000 cu. millimeters = .06 cu. inch  
 1 cu. decimeter = 1000 cu. centimeters = 61.02 cu. inches  
 1 cu. meter = 1000 cu. decimeters = 35.31 cu. feet

## 16.2. Approximate Conversion Factors

To change (imperial)	To (metric)	Multiply by
inches	centimeters	2.540
feet	meters	.305
yards	meters	.914
miles	kilometers	1.609
knots	kph	1.852
square inches	square centimeters	6.451
square feet	square meters	.093
square yards	square meters	.836
square miles	square kilometers	2.590
acres	square hectometers	.405
cubic feet	cubic meters	.028
cubic yards	cubic meters	.765
fluid ounces	milliliters	29,573
pints	liters	.473
quarts	liters	.946
gallons	liters	3.785
ounces	grams	28.349
pounds	kilograms	.454
short tons	metric tons	.907
pound-feet	Newton-meters	1.356
pound-inches	Newton-meters	.11296
ounce-inches	Newton-meters	.007062
(metric)	(imperial)	
centimeters	inches	.394
meters	feet	3.280
meters	yards	1.094
kilometers	miles	.621
kph	knots	0.54
square centimeters	square inches	.155
square meters	square feet	10.764
square meters	square yards	1.196
square kilometers	square miles	.386
square hectometers	acres	2.471
cubic meters	cubic feet	35.315
cubic meters	cubic yards	1.308
milliliters	fluid ounces	.034
liters	pints	2.113
liters	quarts	1.057
liters	gallons	.264
grams	ounces	.035
kilograms	pounds	2.205
metric tons	short tons	1.102



"Enchant by realism!"

belsimtek



17

**DEVELOPERS**

## 17. DEVELOPERS

### **BELSIMTEK**

#### **Management**

Alexander "PilotMi8" Podvoyskiy      Project manager, games and technical documentation, alpha testing.

#### **Documentation**

Vladimir Timofeev      Games documentation: Mi-8 history, aerodynamics, Cockpit systems and controls.

Gene "EvilBivol-1" Bivol      QS manual

#### **Programmers**

Andrey Kovalenko, Nikolay Volodin, Vladimir Mikhailov, Boris Silakov, Alexander Miskovich, Eugeny Gribovich, Maxim Zelensky, Dmitry Moskalenko, Vitaly Perepelkin

#### **Sounds**

Konstantin "btd" Kuznetsov      Music and sound effects

#### **Designers**

Pavel "DGambo" Sidorov      Lead designer cockpit, damage model

Andrey Reshetko      Pilots and gunners

Stanislav Kolesnikov      Cockpit

Valery "Palma" Miagkiy      Options of coloration (livery) of helicopters

#### **Tester staff**

Alexander "AlexanderT" Titarenko

Dmitry "Laivynas" Koshelev

Gene "EvilBivol-1" Bivol

"AlphaOneSix "

"BillyCrusher"

"Derelor"

"FrogFoot"

"Kairat"

"Rik"

"Shadowowweosa"

"Vibora"

"Wadim"

### ***Mission and campaign***

Oleg Dzen Fedorenko, Dmitry Koshelev

### ***Voices recording for campaign***

Russian version:

dr.lex, BTB, Laivynas, Vatel, Dzen, MadShark, wildcat191, Maler, Rustam

English version:

graywo1fg, Weta43, EvilBivol-1, paulrkiii, Joyride, Walter, Curtis, Alex, Jeremy, Headspace, SimFreak, SiThSpAwN

### ***Training missions***

Eugeny "EvilBivol-1" Bivol,  
Vyacheslav "SL PAK" Paketny

### ***Special thanks***

Kairat "Kairat" Jaksbaev (1st class pilot) For organizing audio recording, video, photographs, to help test the dynamics of the model and refinement of work systems in a real helicopter

Oleg Vasilenko (pilot-sniper, test pilot) For photos and videos, to help test the dynamics of the model and refinement of work systems in a real helicopter

Alexander Titorenko (pilot of the Mi-8, civil aviation) For assistance in refining and adding systems, improving the gameplay of the game with Sling load.

"devrim" For the materials of the textures for the English cockpit



Nikolay Karahtincev	"kolyakar"	For adding new liveries for the DCS: Mi-8MTV2
Vitaly "Vert-117"		For invaluable assistance in tuning of systems
Werner Siedenburg	"derelor"	For professionalism and thoroughness in editing this manual
Ralf "upuaut"		For development of new cargos and FARPs for the DCS: Mi-8MTV2
Aleksey "tester"		For help in selection of information for this Flight manual
Vitaly "LazySeal" Kachan		For editing of English version different texts, translation and voice-over of subtitles for Sling load operations

при установке корпуса основного вала  $\alpha$  угол установки комлевого сечения лопасти  $5^\circ$ , далее изменяется по линейному закону до  $0^\circ$  в концевом сечении №22

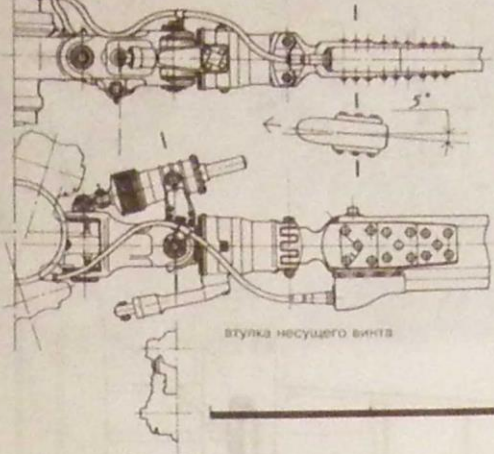

штука несущего винта

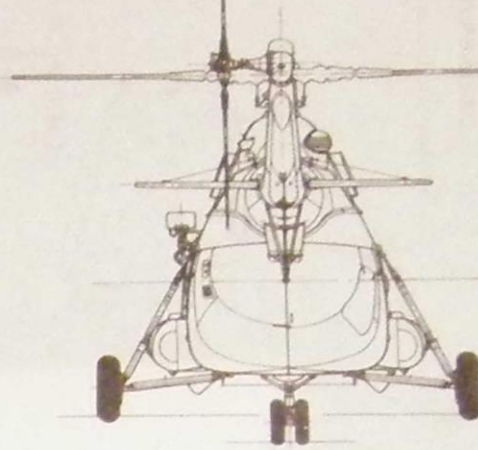
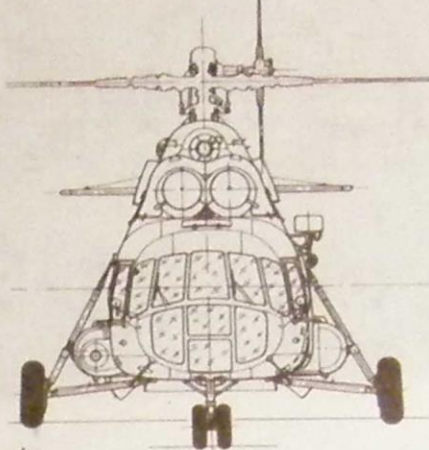

Ми-8МТ

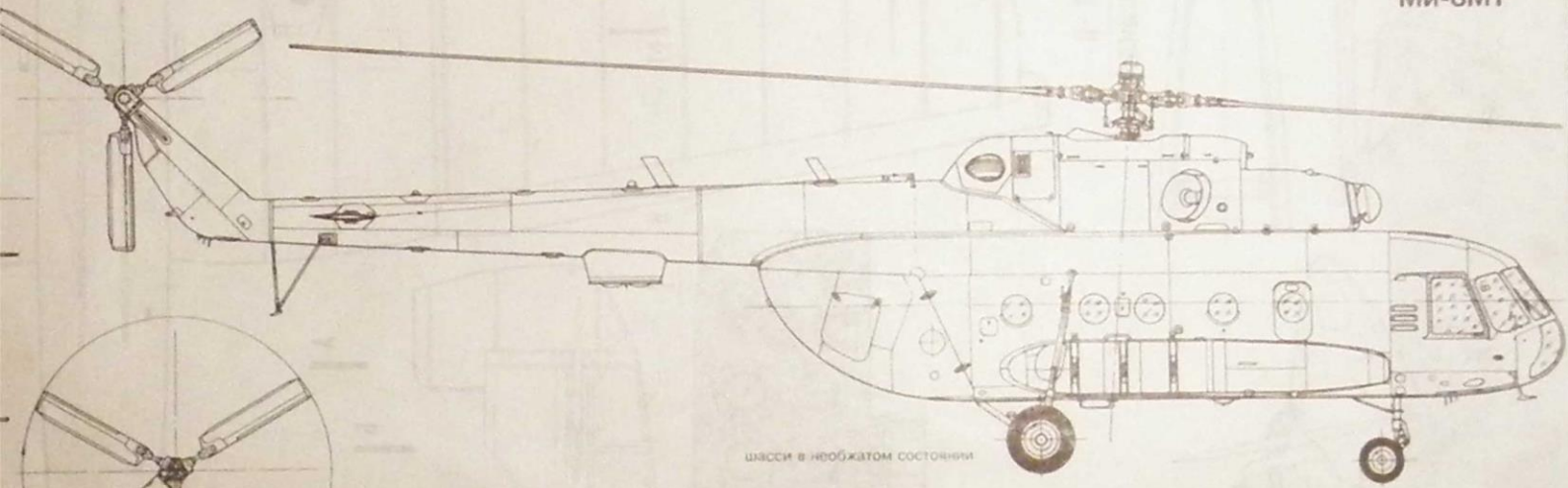

шасси в необжатом состоянии

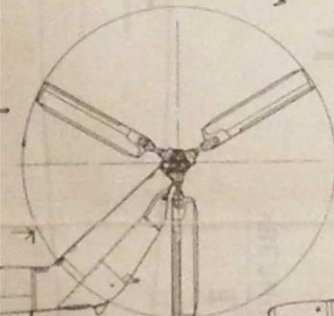

афганский вариант ЗВУ

вариант установки блоков ЛТЦ АСО-2В на фюзеляжи

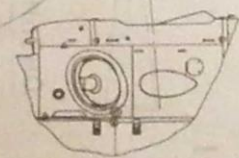

доработка капотов для установки ЗВУ

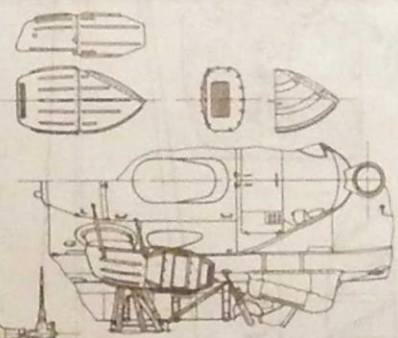

вариант ЗВУ, доработанный после Афганистана

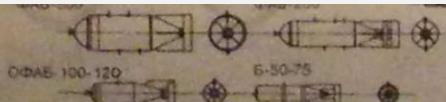
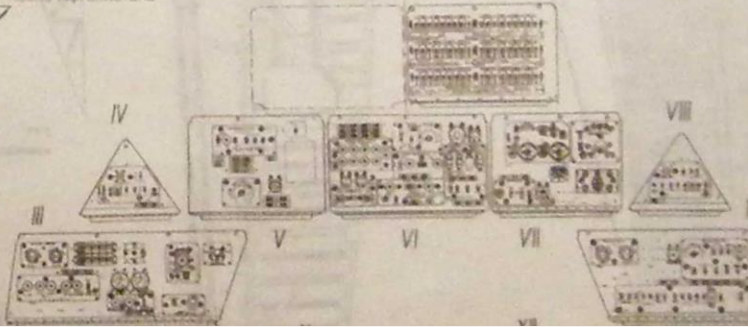
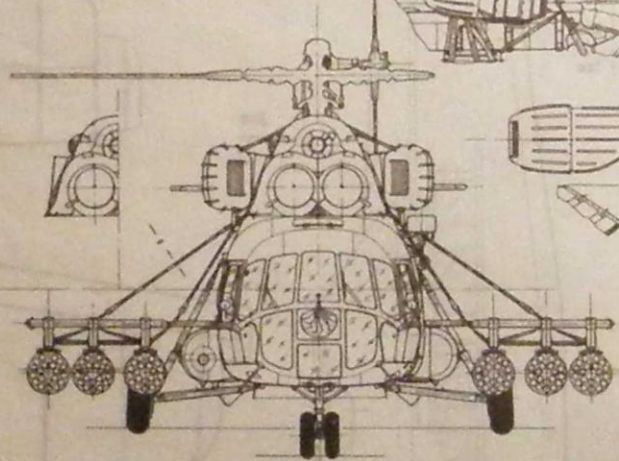
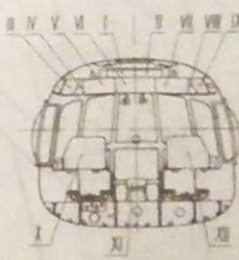

## 18. BIBLIOGRAPHY AND SOURCES

1. Вертолет Ми-8МТ. Техническое описание, 1982.
2. Вертолет Ми-8МТВ. Руководство по эксплуатации и техническому обслуживанию. Книга V. Радиоэлектронное оборудование.
3. Гессоу А., Мейерс Г. Аэродинамика вертолета. Перевод Бирюлина В. Под редакцией Братухина И. – М.: Государственное издательство оборонной промышленности. 1954.
4. Дмитриев В., Вожаев Е., Каргопольцев Е., Приоритетные направления повышения конкурентоспособности вертолетной техники. – ЦАГИ. 2002.
5. Загордан А. Элементарная теория вертолета. – М.: Военное Издательство Министерства Обороны Союза ССР. 1955.
6. Инструкция экипажу вертолета Ми-8МТ. Второе издание, 1982.
7. Ковалев В. Устройство вертолета.
8. РЛЭ Ми-8МТВ5
9. РТЭ двигателя АИ-9в
10. РТЭ двигателя ТВ3-117ВМ
11. РТЭ Ми-8МТВ5
12. Техническое описание АРК-9.
13. Техническое описание АРК-УД.
14. Техническое описание ДИСС-15.
15. Техническое описание П-503Б.
16. Техническое описание Р-828.
17. Техническое описание Р-863.
18. Техническое описание РИ-65Б.
19. Техническое описание СПУ-7.
20. Техническое описание ЯДРО-1А.